



TWINBRIDGE[®] PRODUCTS

UN MUNDO DE POSIBILIDADES



 **SYM**
SURACOPLES Y MANGUERAS LTDA
REPRESENTACIONES

**Adaptadores
Hidráulicos**

INFORMACIÓN GENERAL
SELLOS HIDRAULICOS
NORMAS AMERICANAS

NPTF (30° FLARE)	National Pipe Tapered for Fuel	SAE J516 /J476
NPSM (30° FLARE)	National Pipe Straight thread for Mechanical	J476
NPSF (30° FLARE)	National Pipe Straight thread for Fuels	
JIC (37° FLARE)	Joint Industrial Conference	SAE J514 /J516
SAE (45° FLARE)	Society of Automotive Engineers	
O-RING BOSS		J1926
ORFS	O-Ring Face Seal	SAE J516 /J1453
O-RING FLANGE CODE 61		SAE J518
O-RING FLANGE CODE 62		SAE J518

NORMAS EUROPEAS

BSPP (30° FLARE)	British Standard Pipe Parallel	ISO 228
BSPP (30° FLARE) O-RING	British Standard Pipe Parallel	ISO 1179-3
BSPT (30° FLARE)	British Standard Pipe Tapered	ISO 7-PT
GAZ (24° FLARE)		
DIN (24° FLARE) L.T	Deutsche Industrial Norme	DIN 20066 /3865
DIN (24° FLARE) H.T.	Deutsche Industrial Norme	DIN 20066 /3861

NORMAS JAPONESAS

JIS (30° FLARE)	Japanese Industrial Standard	JIS B 8363
KOMATSU (30° FLARE)		JIS B 8363

GUIA DIMENSIONES DE ROSCAS
TAMAÑO NOMINAL ROSCA

GUIÓN	NPT / NPS	BSP / JIS	JIC / BOSS	SAE - 45°	ORFS A. PLANO	CODIGO 61 D. EXT.	CODIGO 62 D. EXT.	DIN SERIE LIGERA	DIN SERIE PESADA	KOMATSU
-2	1/8-27	1/8-28	5/16-24	5/16-24	M14*1,5	...
-3	3/8-24	3/8-24	M12*1,5	M16*1,5	...
-4	1/4-18	1/4-19	7/16-20	7/16-20	9/16-18	M14*1,5	M18*1,5	M14*1,5
-5	1/2-20	1/2-20	M16*1,5	M20*1,5	...
-6	3/8-18	3/8-19	9/16-18	5/8-18	11/16-16	M18*1,5	M22*1,5	M18*1,5
-7	11/16-16	M22*1,5
-8	1/2-14	1/2-14	3/4-16	3/4-16	13/16-16	30.2	31.7	M22*1,5	M24*1,5	...
-10	...	5/8-14	7/8-14	7/8-14	1-14	34.0	...	M26*1,5	M30*2	M24*1,5
-12	3/4-14	3/4-14	1.1/16-14	1.1/16-14	1.3/16-12	38.1	41.3	M30*1,5	M36*2	M30*1,5
-14	1.3/16-12	1.1/2-12
-16	1-11,5	1-11	1.5/16-12	1.3/8-12	1.7/16-12	44.4	47.6	M36*2	M42*2	M33*1,5
-20	1.1/4-11,5	1.1/4-11	1.5/8-12	...	1.11/16-12	50.8	53.9	M42*2	M45*2	M36*1,5
-24	1.1/2-11,5	1.1/2-11	1.7/8-12	...	2-12	60.3	63.5	M45*2	M52*2	M42*1,5
-32	2-11,5	2-11	2.1/2-12	71.4	79.4	M52*2
-40	84.1
-48	101.6

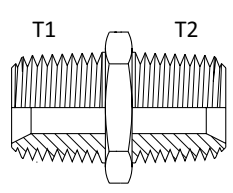
REFERENCIA	PARTE No.	NPTF T1	NPTF T2
T24SA Macho NPTF con Hexagono 	T24SA-02	1/8	1/8
	T24SA-04-02	1/4	1/8
	T24SA-04	1/4	1/4
	T24SA-06-04	3/8	1/4
	T24SA-06	3/8	3/8
	T24SA-08-04	1/2	1/4
	T24SA-08-06	1/2	3/8
	T24SA-08	1/2	1/2
	T24SA-12-08	3/4	1/2
	T24SA-12	3/4	3/4
	T24SA-16-12	1	3/4
	T24SA-16	1	1
	T24SA-20-16	1 1/4	1
	T24SA-20	1 1/4	1 1/4
	T24SA-24	1 1/2	1 1/2
	T24SA-32	2	2

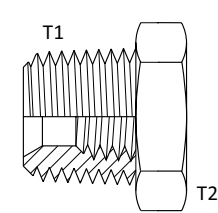
REFERENCIA	PARTE No.	NPTF T1	NPTF T2
T24SB Macho NPTF a Hembra NPTF 	T24SB-04-02	1/4	1/8
	T24SB-06-02	3/8	1/8
	T24SB-06-04	3/8	1/4
	T24SB-08-02	1/2	1/8
	T24SB-08-04	1/2	1/4
	T24SB-08-06	1/2	3/8
	T24SB-12-04	3/4	1/4
	T24SB-12-06	3/4	3/8
	T24SB-12-08	3/4	1/2
	T24SB-16-04	1	1/4
	T24SB-16-06	1	3/8
	T24SB-16-08	1	1/2
	T24SB-16-12	1	3/4
	T24SB-20-08	1 1/4	1/2
	T24SB-20-12	1 1/4	3/4
	T24SB-20-16	1 1/4	1
	T24SB-24-12	1 1/2	3/4
	T24SB-24-16	1 1/2	1
	T24SB-32-16	2	1
	T24SB-32-20	2	1 1/4
T24SB-32-24	2	1 1/2	
T24SB-32-16	2	1	

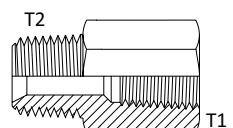
REFERENCIA	PARTE No.	NPTF T1	NPTF T2
T24SG Hembra NPTF a Macho NPTF 	T24SG-04-02	1/4	1/8
	T24SG-06-04	3/8	1/4
	T24SG-08-02	1/2	1/8
	T24SG-08-04	1/2	1/4
	T24SG-08-06	1/2	3/8
	T24SG-12-04	3/4	1/4
	T24SG-12-08	3/4	1/2
	T24SG-16-06	1	3/8
	T24SG-16-08	1	1/2
	T24SG-16-12	1	3/4
	T24SG-20-16	1 1/4	1
	T24SG-24-20	1 1/2	1 1/4
	T24SG-32-24	2	1 1/2

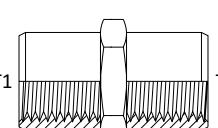
REFERENCIA	PARTE No.	NPTF T1	NPTF T2
T24SJ Unión Hembra NPTF 	T24SJ-02	1/8	1/8
	T24SJ-04	1/4	1/4
	T24SJ-04-02	1/4	1/8
	T24SJ-06	3/8	3/8
	T24SJ-06-04	3/8	1/4
	T24SJ-08	1/2	1/2
	T24SJ-08-06	1/2	3/8
	T24SJ-12	3/4	3/4
	T24SJ-12-08	3/4	1/2
	T24SJ-16	1	1
	T24SJ-20	1 1/4	1 1/4
	T24SJ-24	1 1/2	1 1/2

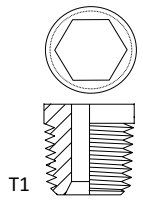
REFERENCIA	PARTE No.	NPTF T1	
T24SR Tapón Macho NPTF Hexagono Pulg 	T24SR-02	1/8	
	T24SR-04	1/4	
	T24SR-06	3/8	
	T24SR-08	1/2	
	T24SR-12	3/4	
	T24SR-16	1	
	T24SR-20	1 1/4	
	T24SR-24	1 1/2	
	T24SR-32	2	

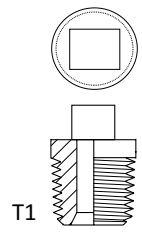
REFERENCIA	PARTE No.	NPTF T1		
T25SP Tapón Macho NPTF Cabeza Cuadrada 	T25SP-02	1/8		
	T25SP-04	1/4		
	T25SP-06	3/8		
	T25SP-08	1/2		
	T25SP-12	3/4		
	T25SP-16	1		
	T25SP-20	1 1/4		

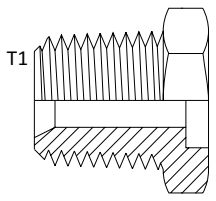
REFERENCIA	PARTE No.	NPTF T1	
T24ST Macho NPTF Cabeza Hexagonal 	T24ST-02	1/8	
	T24ST-04	1/4	
	T24ST-06	3/8	
	T24ST-08	1/2	
	T24ST-12	3/4	
	T24ST-16	1	
	T24ST-20	1 1/4	
	T24ST-24	1 1/2	
	T24ST-32	2	

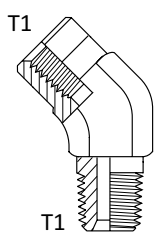
REFERENCIA	PARTE No.	NPTF T1		
T25TG Codo 45° Macho NPTF a Hembra NPTF 	T25TG-02	1/8		
	T25TG-04	1/4		
	T25TG-06	3/8		
	T25TG-08	1/2		
	T25TG-12	3/4		
	T25TG-16	1		
	T25TG-20	1 1/4		

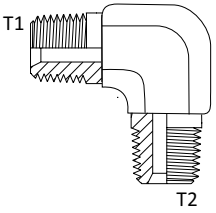
REFERENCIA	PARTE No.	NPTF T1	NPTF T2
T25UA Codo 90º Macho NPTF 	T25UA-02	1/8	1/8
	T25UA-04	1/4	1/4
	T25UA-06-04	3/8	1/4
	T25UA-06	3/8	3/8
	T25UA-08-06	1/2	3/8
	T25UA-08	1/2	1/2
	T25UA-12-08	3/4	1/2
	T25UA-12	3/4	3/4
	T25UA-16	1	1
	T25UA-16-12	1	3/4
	T25UA-20	1 1/4	1 1/4
	T25UA-24	1 1/2	1 1/2

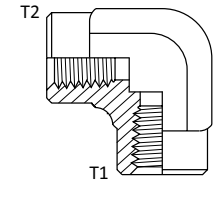
REFERENCIA	PARTE No.	NPTF T1	NPTF T2
T25UG Codo 90º Macho NPTF a Hembra NPTF 	T25UG-02	1/8	1/8
	T25UG-02-04	1/8	1/4
	T25UG-04	1/4	1/4
	T25UG-04-02	1/4	1/8
	T25UG-04-06	1/4	3/8
	T25UG-06	3/8	3/8
	T25UG-06-04	3/8	1/4
	T25UG-06-08	3/8	1/2
	T25UG-08	1/2	1/2
	T25UG-08-06	1/2	3/8
	T25UG-08-12	1/2	3/4
	T25UG-12	3/4	3/4
	T25UG-12-08	3/4	1/2
	T25UG-16	1	1
	T25UG-20	1 1/4	1 1/4
	T25UG-24	1 1/2	1 1/2
	T25UG-32	2	2

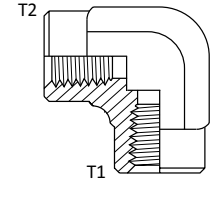
REFERENCIA	PARTE No.	NPTF T1	
T25UJ Codo 90º Hembra NPTF 	T25UJ-02	1/8	
	T25UJ-04	1/4	
	T25UJ-06	3/8	
	T25UJ-08	1/2	
	T25UJ-12	3/4	
	T25UJ-16	1	
	T25UJ-20	1 1/4	
	T25UJ-24	1 1/2	
	T25UJ-32	2	

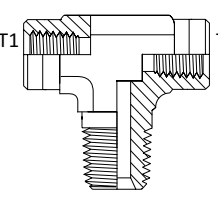
REFERENCIA	PARTE No.	NPTF T1	
T25VC TEE Hembra NPTF - Hembra NPTF a Macho NPTF 	T25VC-02	1/8	
	T25VC-04	1/4	
	T25VC-06	3/8	
	T25VC-08	1/2	
	T25VC-12	3/4	
	T25VC-16	1	
	T25VC-20	1 1/4	
	T25VC-24	1 1/2	
	T25VC-32	2	

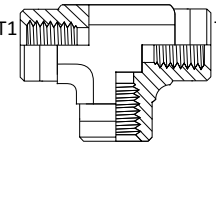
REFERENCIA	PARTE No.	NPTF T1	
T25VJ TEE Hembra NPTF 	T25VJ-02	1/8	
	T25VJ-04	1/4	
	T25VJ-06	3/8	
	T25VJ-08	1/2	
	T25VJ-12	3/4	
	T25VJ-16	1	
	T25VJ-24	1 1/2	

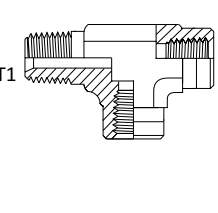
REFERENCIA	PARTE No.	NPTF T1	
T25VK TEE Macho NPTF a Hembra NPTF 	T25VK-02	1/8	
	T25VK-04	1/4	
	T25VK-06	3/8	
	T25VK-08	1/2	
	T25VK-12	3/4	
	T25VK-16	1	
	T25VK-20	1 1/4	
	T25VK-24	1 1/2	
	T25VK-32	2	

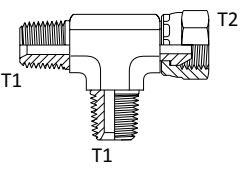
REFERENCIA	PARTE No.	NPTF T1	NPTF T2
T25VT TEE Macho NPTF a Hembra NPTF A Macho NPTF 	T25VT-02	1/8	1/8
	T25VT-04	1/4	1/4
	T25VT-06	3/8	3/8
	T25VT-08	1/2	1/2
	T25VT-12	3/4	3/4

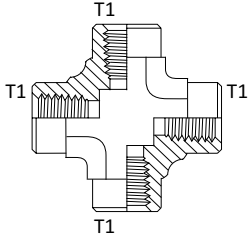
REFERENCIA	PARTE No.	NPTF T1	NPTF T2
T25WJ Cruz Hembra NPTF 	T25WJ-02	1/8	
	T25WJ-04	1/4	
	T25WJ-06	3/8	
	T25WJ-08	1/2	
	T25WJ-12	3/4	
	T25WJ-16	1	

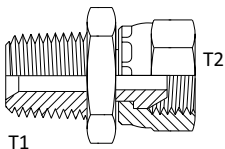
REFERENCIA	PARTE No.	NPTF T1	NPSM T2
T60SA Macho NPTF a Hembra NPSM 	T60SA-02-02	1/8-27	1/8-27
	T60SA-02-04	1/8-27	1/4-18
	T60SA-04-02	1/4-18	1/8-27
	T60SA-04-04	1/4-18	1/4-18
	T60SA-04-06	1/4-18	3/8-18
	T60SA-06-04	3/8-18	1/4-18
	T60SA-06-06	3/8-18	3/8-18
	T60SA-06-08	3/8-18	1/2-14
	T60SA-08-04	1/2-14	1/4-18
	T60SA-08-06	1/2-14	3/8-18
	T60SA-08-08	1/2-14	1/2-14
	T60SA-08-12	1/2-14	3/4-14
	T60SA-12-08	3/4-14	1/2-14
	T60SA-12-12	3/4-14	3/4-14
	T60SA-12-16	3/4-14	1-11 1/2
	T60SA-16-12	1-11 1/2	3/4-14
	T60SA-16-16	1-11 1/2	1-11 1/2
	T60SA-16-20	1-11 1/2	1 1/4-11 1/2
	T60SA-20-16	1 1/4-11 1/2	1-11 1/2
	T60SA-20-20	1 1/4-11 1/2	1 1/4-11 1/2
T60SA-20-24	1 1/4-11 1/2	1 1/2-11 1/2	
T60SA-24-24	1 1/2-11 1/2	1 1/2-11 1/2	
T60SA-32-32	2-11 1/2	2-11 1/2	

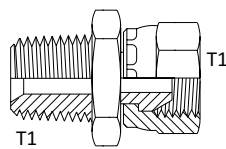
REFERENCIA	PARTE No.	NPTF T1	NPSM T2
T64SA Macho NPTF a Hembra NPSM 	T64SA-04-04	1/4-18	
	T64SA-06-06	3/8-18	
	T64SA-08-08	1/2-14	
	T64SA-12-12	3/4-14	

REFERENCIA	PARTE No.	O-BOSS T1	NPSM T2
T60SB Macho O-RING-BOSS a Hembra NPSM	T60SB-04-02	7/16-20	1/8-27
	T60SB-04-04	7/16-20	1/4-18
	T60SB-05-04	1/2-20	1/4-18
	T60SB-06-04	9/16-18	1/4-18
	T60SB-06-06	9/16-18	3/8-18
	T60SB-06-08	9/16-18	1/2-14
	T60SB-08-04	3/4-16	1/4-18
	T60SB-08-06	3/4-16	3/8-18
	T60SB-08-08	3/4-16	1/2-14
	T60SB-08-12	3/4-16	3/4-14
	T60SB-10-06	7/8-14	3/8-18
	T60SB-10-08	7/8-14	1/2-14
	T60SB-10-12	7/8-14	3/4-14
	T60SB-12-08	1 1/16-12	1/2-14
	T60SB-12-12	1 1/16-12	3/4-14
	T60SB-12-16	1 1/16-12	1-11 1/2
	T60SB-14-12	1 3/16-12	3/4-14
	T60SB-16-12	1 5/16-12	3/4-14
	T60SB-16-16	1 5/16-12	1-11 1/2
	T60SB-16-20	1 5/16-12	1-1/4-11 1/2
	T60SB-20-16	1 5/8-1/2	1-11 1/2
	T60SB-20-20	1 5/8-1/2	1 1/4-11 1/2
	T60SB-24-24	1 7/8-1/2	1 1/2-11 1/2

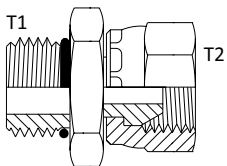

REFERENCIA	PARTE No.	NPTF T1	NPSM T2
T60SG Hembra NPTF a Hembra NPSM	T60SG-02-02	1/8-27	1/8-27
	T60SG-02-04	1/8-27	1/4-18
	T60SG-04-02	1/4-18	1/8-27
	T60SG-04-04	1/4-18	1/4-18
	T60SG-04-08	1/4-18	1/2-14
	T60SG-06-04	3/8-18	1/4-18
	T60SG-06-06	3/8-18	3/8-18
	T60SG-06-08	3/8-18	1/2-14
	T60SG-08-04	1/2-14	1/4-18
	T60SG-08-06	1/2-14	3/8-18
	T60SG-08-08	1/2-14	1/2-14
	T60SG-12-08	3/4-14	1/2-14
	T60SG-12-12	3/4-14	3/4-14
	T60SG-12-16	3/4-14	1-11 1/2
	T60SG-16-12	1-11 1/2	3/4-14
	T60SG-16-16	1-11 1/2	1-11 1/2
	T60SG-20-20	1 1/4-11 1/2	1 1/4-11 1/2
	T60SG-24-24	1 1/2-11 1/2	1 1/2-11 1/2
	T60SG-32-32	2-11 1/2	2-11 1/2

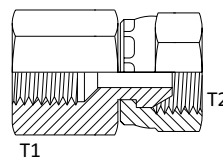

REFERENCIA	PARTE No.	NPTF T1	NPSM T2
T64SG Hembra NPTF a Hembra NPSM Alta presión	T64SG-04-04	1/4-18	1/4-18
	T64SG-06-06	3/8-18	3/8-18
	T64SG-08-08	1/2-14	1/2-14
	T64SG-12-12	3/4-14	3/4-14

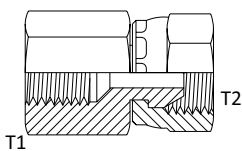

REFERENCIA	PARTE No.	NPTF T1	NPSM T2
T60TA Codo 45° Macho NPTF a Hembra NPSM	T60TA-02-02	1/8-27	1/8-27
	T60TA-04-04	1/4-18	1/4-18
	T60TA-04-06	1/4-18	3/8-18
	T60TA-06-06	3/8-18	3/8-18
	T60TA-06-08	3/8-18	1/2-14
	T60TA-08-04	1/2-14	1/4-18
	T60TA-08-06	1/2-14	3/8-18
	T60TA-08-08	1/2-14	1/2-14
	T60TA-08-12	1/2-14	3/4-14
	T60TA-12-08	3/4-14	1/2-14
	T60TA-12-12	3/4-14	3/4-14
	T60TA-12-16	3/4-14	1-11 1/2
	T60TA-16-12	1-11 1/2	3/4-14
	T60TA-16-16	1-11 1/2	1-11 1/2
	T60TA-16-20	1-11 1/2	1 1/4-11 1/2
	T60TA-20-16	1 1/4-11 1/2	1-11 1/2
	T60TA-20-20	1 1/4-11 1/2	1 1/4-11 1/2
	T60TA-24-24	1 1/2-11 1/2	1 1/2-11 1/2
	T60TA-32-32	2-11 1/2	2-11 1/2

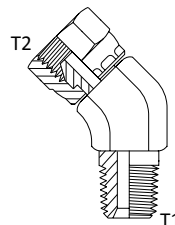

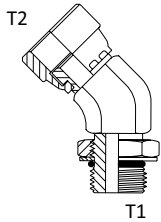
REFERENCIA	PARTE No.	O-BOSS T1	NPSM T2
T60TB Codo 45° Macho O-RING BOSS a Hembra NPSM 	T60TB-04-04	7/16-20	1/4-18
	T60TB-06-04	9/16-18	1/4-18
	T60TB-06-06	9/16-18	3/8-18
	T60TB-06-08	9/16-18	1/2-14
	T60TB-08-06	3/4-16	3/8-18
	T60TB-08-08	3/4-16	1/2-14
	T60TB-08-12	3/4-16	3/4-14
	T60TB-10-04	7/8-14	1/4-18
	T60TB-10-06	7/8-14	3/8-18
	T60TB-10-08	7/8-14	1/2-14
	T60TB-10-12	7/8-14	3/4-14
	T60TB-12-06	1 1/16-12	3/8-18
	T60TB-12-08	1 1/16-12	1/2-14
	T60TB-12-12	1 1/16-12	3/4-14
	T60TB-12-16	1 1/16-12	1-11 1/2
	T60TB-16-12	1 5/16-12	3/4-14
	T60TB-16-16	1 5/16-12	1-11 1/2

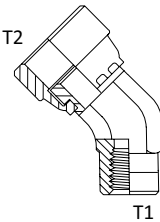
REFERENCIA	PARTE No.	NPTF T1	NPSM T2
T60TG Codo 45° Hembra NPTF a hembra NPSM 	T60TG-04-04	1/4 - 18	1/4 - 18
	T60TG-06-06	3/8 - 18	3/8 - 18
	T60TG-08-06	1/2 - 14	3/8 - 18
	T60TG-12-08	3/4 - 14	1/2 - 14
	T60TG-12-12	3/4 - 14	3/4 - 14
	T60TG-16-12	1-11/12	3/4 - 14
	T60TG-16-16	1-11/12	1-11/12
	T60TG-20-20	1 1/4-11 1/2	1 1/4-11 1/2
	T60TG-24-24	1 1/2-11 1/2	1 1/2-11 1/2

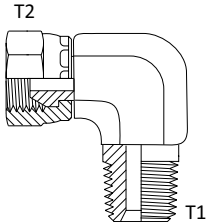
REFERENCIA	PARTE No.	NPTF T1	NPSM T2
T60UA Codo 90° Macho NPTF a Hembra NPSM 	T60UA-02-02	1/8-27	1/8-27
	T60UA-02-04	1/8-27	1/4-18
	T60UA-04-04	1/4-18	1/4-18
	T60UA-04-06	1/4-18	3/8-18
	T60UA-06-04	3/8-18	1/4-18
	T60UA-06-06	3/8-18	3/8-18
	T60UA-06-08	3/8-18	1/2-14
	T60UA-08-04	1/2-14	1/4-18
	T60UA-08-06	1/2-14	3/8-18
	T60UA-08-08	1/2-14	1/2-14
	T60UA-08-12	1/2-14	3/4-14
	T60UA-12-06	3/4-14	3/8-18
	T60UA-12-08	3/4-14	1/2-14
	T60UA-12-12	3/4-14	3/4-14
	T60UA-12-16	3/4-14	1-11 1/2
	T60UA-16-08	1-11 1/2	1/2-14
	T60UA-16-12	1-11 1/2	1-11 1/2
	T60UA-16-16	1-11 1/2	1-11 1/2
	T60UA-16-20	1-11 1/2	1 1/4-11 1/2
	T60UA-20-16	1 1/4-11 1/2	1-11 1/2
T60UA-20-20	1 1/4-11 1/2	1 1/4-11 1/2	
T60UA-20-24	1 1/4-11 1/2	1 1/2-11 1/2	
T60UA-24-24	1 1/2-11 1/2	1 1/2-11 1/2	
T60UA-32-32	2-11 1/2	2-11 1/2	

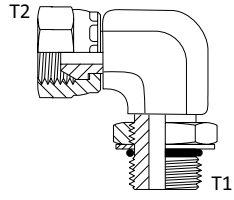
REFERENCIA	PARTE No.	O-BOSS T1	NPSM T2
T60UB Codo 90° Macho O-RING BOSS a Hembra NPSM 	T60UB-04-04	7/16-20	1/4-18
	T60UB-04-06	7/16-20	3/8-18
	T60UB-06-04	9/16-18	1/4-18
	T60UB-06-06	9/16-18	3/8-18
	T60UB-06-08	9/16-18	1/2-14
	T60UB-08-04	3/4-16	1/4-18
	T60UB-08-06	3/4-16	3/8-18
	T60UB-08-08	3/4-16	1/2-14
	T60UB-08-12	3/4-16	3/4-14
	T60UB-10-06	7/8-14	3/8-18
	T60UB-10-08	7/8-14	1/2-14
	T60UB-10-12	7/8-14	3/4-14
	T60UB-12-08	1 1/16-12	1/2-14
	T60UB-12-12	1 1/16-12	3/4-14
	T60UB-12-16	1 1/16-12	1-11 1/2
	T60UB-14-12	1 3/16-12	3/4-14
	T60UB-16-12	1 5/16-12	3/4-14
	T60UB-16-16	1 5/16-12	1-11 1/2
T60UB-16-20	1 5/16-12	1 1/4-11 1/2	
T60UB-20-20	1 5/8-12	1 1/4-11 1/2	
T60UB-24-24	1 7/8-12	1 1/2-11 1/2	

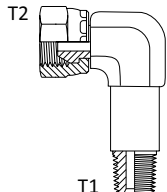
REFERENCIA	PARTE No.	NPTF T1	NPSM T2
T60UC Codo 90° Largo Macho NPTF a Hembra NPSM 	T60UC-02-02	1/8-27	1/8-27
	T60UC-04-04	1/4-18	1/4-18
	T60UC-06-06	3/8-18	3/8-18
	T60UC-06-08	3/8-18	1/2-14
	T60UC-08-08	1/2-14	1/2-14
	T60UC-12-12	3/4-14	3/4-14
	T60UC-16-16	1-11 1/2	1-11 1/2

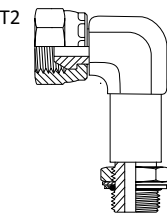
REFERENCIA	PARTE No.	O-BOSS T1	NPSM T2
T60UD Codo 90° Largo Macho O-RING BOSS a Hembra NPSM 	T60UD-04-04	7/16-20	1/4-18
	T60UD-06-06	9/16-18	3/8-18
	T60UD-08-06	3/4-16	3/8-18
	T60UD-08-08	3/4-16	1/2-14
	T60UD-10-08	7/8-14	1/2-14
	T60UD-10-12	7/8-14	3/4-14
	T60UD-12-12	1 1/16-12	3/4-14

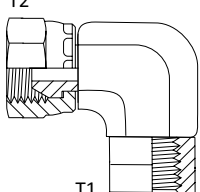
REFERENCIA	PARTE No.	NPTF T1	NPSM T2
T60UG Codo 90° Hembra NPTF a Hembra NPSM 	T60UG-02-02	1/8-27	1/8-27
	T60UG-04-04	1/4-18	1/4-18
	T60UG-06-04	3/8-18	1/4-18
	T60UG-06-06	3/8-18	3/8-18
	T60UG-08-06	1/2-14	3/8-18
	T60UG-08-08	1/2-14	1/2-14
	T60UG-12-12	3/4-14	3/4-14
	T60UG-16-12	1-11 1/2	3/4-14
	T60UG-16-16	1-11 1/2	1-11 1/2
	T60UG-20-20	1 1/4-11 1/2	1 1/4-11 1/2
	T60UG-24-24	1 1/2-11 1/2	1 1/2-11 1/2

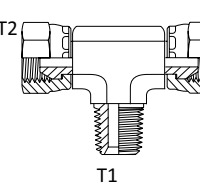
REFERENCIA	PARTE No.	NPTF T1	NPSM T2	
T60VC Tee Macho NPTF a Hembra NPSM a Hembra NPSM 	T60VC-04-04	1/4 - 18	1/4 - 18	
	T60VC-06-06	3/8 - 18	3/8 - 18	
	T60VC-06-08	3/8 - 18	1/2 - 14	
	T60VC-08-06	1/2 - 14	3/8 - 18	
	T60VC-08-08	1/2 - 14	1/2 - 14	
	T60VC-12-08	3/4 - 14	1/2 - 14	
	T60VC-12-12	3/4 - 14	3/4 - 14	
	T60VC-16-16	1-11 1/2	1-11 1/2	

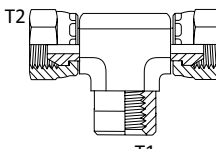
REFERENCIA	PARTE No.	NPTF T1	NPSM T2
T60VH Tee Hembra NPTF a Hembra NPSM - Hembra NPSM 	T60VH-04-04	1/4-18	1/4-18
	T60VH-06-06	3/8-18	3/8-18
	T60VH-08-06	1/2-14	3/8-18
	T60VH-08-08	1/2-14	1/2-14
	T60VH-12-08	3/4-14	1/2-14
	T60VH-12-12	3/4-14	3/4-14
	T60VH-16-16	1-11 1/2	1-11 1/2

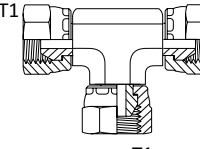
REFERENCIA	PARTE No.	NPSM T1	NPSM T2
T60VJ Tee Hembra NPSM 	T60VJ-02	1/8-27	
	T60VJ-04	1/4-18	
	T60VJ-06	3/8-18	
	T60VJ-08	1/2-14	
	T60VJ-12	3/4-14	

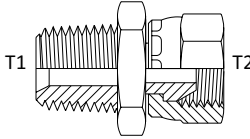
REFERENCIA	PARTE No.	NPTF T1	NPSM T2
T61SA Macho NPTF a Hembra NPSM 	T61SA-04-04-000	1/4-18	1/4-18
	T61SA-04-04-014	1/4-18	1/4-18
	T61SA-04-04-015	1/4-18	1/4-18
	T61SA-04-04-016	1/4-18	1/4-18
	T61SA-04-04-020	1/4-18	1/4-18
	T61SA-04-04-026	1/4-18	1/4-18
	T61SA-04-04-031	1/4-18	1/4-18
	T61SA-04-04-035	1/4-18	1/4-18
	T61SA-04-04-040	1/4-18	1/4-18
	T61SA-04-04-046	1/4-18	1/4-18
	T61SA-04-04-049	1/4-18	1/4-18
	T61SA-04-04-052	1/4-18	1/4-18
	T61SA-04-04-055	1/4-18	1/4-18
	T61SA-04-04-060	1/4-18	1/4-18
	T61SA-04-04-062	1/4-18	1/4-18
	T61SA-04-04-078	1/4-18	1/4-18
	T61SA-04-04-094	1/4-18	1/4-18
	T61SA-04-04-104	1/4-18	1/4-18
	T61SA-04-04-125	1/4-18	1/4-18
	T61SA-04-04-156	1/4-18	1/4-18
	T61SA-04-04-170	1/4-18	1/4-18
	T61SA-06-06-000	3/8-18	3/8-18
	T61SA-06-06-031	3/8-18	3/8-18
	T61SA-06-06-040	3/8-18	3/8-18
	T61SA-06-06-052	3/8-18	3/8-18
	T61SA-06-06-062	3/8-18	3/8-18
	T61SA-06-06-078	3/8-18	3/8-18
	T61SA-06-06-140	3/8-18	3/8-18
	T61SA-08-08-000	1/2-14	1/2-14
	T61SA-08-08-031	1/2-14	1/2-14
	T61SA-08-08-035	1/2-14	1/2-14
	T61SA-08-08-042	1/2-14	1/2-14
	T61SA-08-08-047	1/2-14	1/2-14
	T61SA-08-08-052	1/2-14	1/2-14
	T61SA-08-08-062	1/2-14	1/2-14
	T61SA-08-08-076	1/2-14	1/2-14
	T61SA-08-08-078	1/2-14	1/2-14
	T61SA-08-08-081	1/2-14	1/2-14
	T61SA-08-08-089	1/2-14	1/2-14
	T61SA-08-08-094	1/2-14	1/2-14
T61SA-08-08-104	1/2-14	1/2-14	
T61SA-08-08-125	1/2-14	1/2-14	
T61SA-08-08-250	1/2-14	1/2-14	
T61SA-08-08-394	1/2-14	1/2-14	

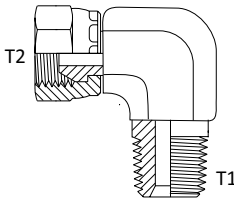
REFERENCIA	PARTE No.	NPTF T1	NPSM T2
T61UA Codo 90° Macho NPTF a Hembra NPSM 	T61UA-04-04-000	1/4-18	1/4-18
	T61UA-04-04-031	1/4-18	1/4-18
	T61UA-04-04-040	1/4-18	1/4-18
	T61UA-04-04-052	1/4-18	1/4-18
	T61UA-04-04-062	1/4-18	1/4-18
	T61UA-04-04-098	1/4-18	1/4-18
	T61UA-04-04-113	1/4-18	1/4-18
	T61UA-06-06-000	3/8-18	3/8-18
	T61UA-06-06-031	3/8-18	3/8-18
	T61UA-06-06-040	3/8-18	3/8-18
	T61UA-06-06-062	3/8-18	3/8-18
	T61UA-06-06-078	3/8-18	3/8-18
	T61UA-06-06-094	3/8-18	3/8-18
	T61UA-06-06-125	3/8-18	3/8-18
	T61UA-08-08-000	1/2-14	1/2-14
	T61UA-08-08-046	1/2-14	1/2-14
	T61UA-08-08-060	1/2-14	1/2-14

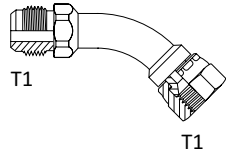
REFERENCIA	PARTE No.	JIC T1	JIC T2
T63TA Codo 45° Macho JIC - Hembra JIC 	T63TA-04-04	7/16-20	
	T63TA-05-05	1/2-20	
	T63TA-06-06	9/16-18	
	T63TA-08-08	3/4-16	
	T63TA-10-10	7/8-14	
	T63TA-12-12	1 1/16-12	
	T63TA-16-16	1 5/16-12	

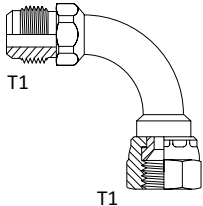
REFERENCIA	PARTE No.	JIC T1	JIC T2
T63UA Codo 90° Macho JIC a Hembra JIC 	T63UA-04-04	7/16-20	
	T63UA-05-05	1/2-20	
	T63UA-06-06	9/16-18	
	T63UA-08-08	3/4-16	
	T63UA-10-10	7/8-14	
	T63UA-12-12	1 1/16-12	
	T63UA-16-16	1 5/16-12	
	T63UA-20-20	1 5/8-12	

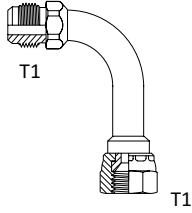
REFERENCIA	PARTE No.	JIC T1	JIC T2
T63UC Codo 90° Macho JIC a Hembra JIC 	T63UC-04-04	7/16-20	
	T63UC-05-05	1/2-20	
	T63UC-06-06	9/16-18	
	T63UC-08-08	3/4-16	
	T63UC-10-10	7/8-14	
	T63UC-12-12	1 1/16-12	
	T63UC-16-16	1 5/16-12	
	T63UC-20-20	1 5/8-12	

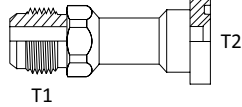
REFERENCIA	PARTE No.	JIC T1	BRIDA T2
T63SB Macho JIC a Brida Código 61 - R2 	T63SB-08-08	3/4-16	1.19
	T63SB-08-12	3/4-16	1.50
	T63SB-12-12	1 1/16-12	1.50
	T63SB-12-16	1 1/16-12	1.75
	T63SB-16-16	1 5/16-12	1.75
	T63SB-16-20	1 5/16-12	2.00
	T63SB-20-20	1 5/8-12	2.00
	T63SB-20-24	1 5/8-12	2.37
	T63SB-24-20	1 7/8-12	2.00
	T63SB-24-24	1 7/8-12	2.37
	T63SB-32-32	2 1/2-12	2.81

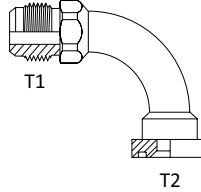
REFERENCIA	PARTE No.	JIC T1	BRIDA T2
T63UB Codo 90° Macho JIC a Brida Código 61 - R2 	T63UB-08-08	3/4-16	1.19
	T63UB-08-12	3/4-16	1.50
	T63UB-12-12	1 1/16-12	1.50
	T63UB-12-16	1 1/16-12	1.75
	T63UB-16-16	1 5/16-12	1.75
	T63UB-16-20	1 5/16-12	2.00
	T63UB-16-24	1 5/16-12	2.37
	T63UB-20-16	1 5/8-12	1.75
	T63UB-20-20	1 5/8-12	2.00
	T63UB-20-24	1 5/8-12	2.37
	T63UB-24-24	1 7/8-12	2.37
	T63UB-32-32	2 1/2-12	2.81

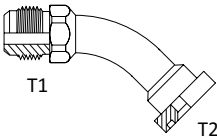
REFERENCIA	PARTE No.	JIC T1	BRIDA T2
T63TB Codo 45° Macho JIC a Brida Código: 61 - R2 	T63TB-08-08	3/4-16	1.19
	T63TB-12-12	1 1/16-12	1.50
	T63TB-12-16	1 1/16-12	1.75
	T63TB-16-16	1 5/16-12	1.75
	T63TB-16-20	1 5/16-12	2.00
	T63TB-20-20	1 5/8-12	2.00
	T63TB-20-24	1 5/8-12	2.37
	T63TB-24-24	1 7/8-12	2.37
	T63TB-32-32	2 1/2-12	2.81

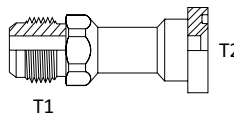
REFERENCIA	PARTE No.	JIC T1	BRIDA T2
T63SE Macho JIC a Brida Código 61 	T63SE-12-12	1 1/16-12	1.50
	T63SE-12-16	1 1/16-12	1.75
	T63SE-16-16	1 5/16-12	1.75
	T63SE-16-20	1 5/16-12	2.00
	T63SE-20-20	1 5/8-12	2.00
	T63SE-20-24	1 5/8-12	2.37
	T63SE-24-24	1 7/8-12	2.37
	T63SE-32-32	2 1/2-12	2.81

REFERENCIA	PARTE No.	JIC T1	BRIDA T2
T63TE Codo 45° Macho JIC a Brida Código: 61	T63TE-12-12	1 1/16-12	1.50
	T63TE-12-16	1 1/16-12	1.75
	T63TE-16-16	1 5/16-12	1.75
	T63TE-16-20	1 5/16-12	2.00
	T63TE-20-20	1 5/8-12	2.00
	T63TE-20-24	1 5/8-12	2.37
	T63TE-24-24	1 7/8-12	2.37
	T63TE-32-32	2 1/2-12	2.81

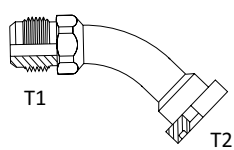

REFERENCIA	PARTE No.	JIC T1	BRIDA T2
T63UE Codo 90° macho JIC a Brida Código 61	T63UE-12-12	1 1/16-12	1.50
	T63UE-12-16	1 1/16-12	1.75
	T63UE-16-16	1 5/16-12	1.75
	T63UE-16-20	1 5/16-12	2.00
	T63UE-20-20	1 5/8-12	2.00
	T63UE-20-24	1 5/8-12	2.37
	T63UE-24-24	1 7/8-12	2.37
	T63UE-32-32	2 1/2-12	2.81

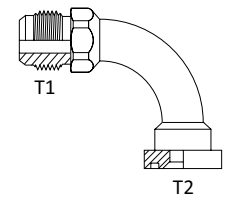

REFERENCIA	PARTE No.	JIC T1	BRIDA T2
T63SF Macho JIC a Brida Código: 62	T63SF-12-12	1 1/16-12	1.62
	T63SF-12-16	1 1/16-12	1.87
	T63SF-16-16	1 5/16-12	1.87
	T63SF-16-20	1 5/16-12	2.12
	T63SF-20-20	1 5/8-12	2.12
	T63SF-20-24	1 5/8-12	2.50
	T63SF-24-24	1 7/8-12	2.50
	T63SF-32-32	2 1/2-12	3.12

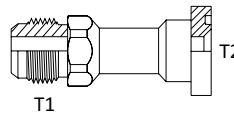

REFERENCIA	PARTE No.	JIC T1	BRIDA T2
T63TF Codo 45° Macho JIC a Brida Código 62	T63TF-12-12	1 1/16-12	1.62
	T63TF-12-16	1 1/16-12	1.87
	T63TF-16-16	1 5/16-12	1.87
	T63TF-16-20	1 5/16-12	2.12
	T63TF-20-20	1 5/8-12	2.12
	T63TF-20-24	1 5/8-12	2.50
	T63TF-24-24	1 7/8-12	2.50
	T63TF-32-32	2 1/2-12	3.12

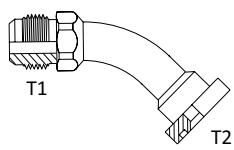

REFERENCIA	PARTE No.	JIC T1	BRIDA T2
T63UF Codo 90° Macho JIC a Brida Código: 62	T63UF-12-12	1 1/16-12	1.62
	T63UF-12-16	1 1/16-12	1.87
	T63UF-16-12	1 5/16-12	1.62
	T63UF-16-16	1 5/16-12	1.87
	T63UF-16-20	1 5/16-12	2.12
	T63UF-20-12	1 5/8-12	1.62
	T63UF-20-20	1 5/8-12	2.12
	T63UF-20-24	1 5/8-12	2.50
	T63UF-24-24	1 7/8-12	2.50
	T63UF-32-32	2 1/2-12	3.12

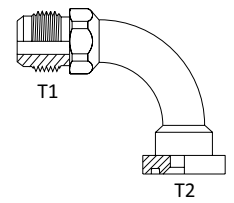

REFERENCIA	PARTE No.	O-BOSS T1	O-BOSS T2
T719-FSO Macho O-RING BOSS - Hembra O-RING BOSS	T719-FSO-04-06	7/16-20	9/16-18
	T719-FSO-06-04	9/16-18	7/16-20
	T719-FSO-06-08	9/16-18	3/4-16
	T719-FSO-08-04	3/4-16	7/16-20
	T719-FSO-08-06	3/4-16	9/16-18
	T719-FSO-08-10	3/4-16	7/8-14
	T719-FSO-08-12	3/4-16	1 1/16-12
	T719-FSO-10-04	7/8-14	7/16-20
	T719-FSO-10-06	7/8-14	9/16-18
	T719-FSO-10-08	7/8-14	3/4-16
	T719-FSO-10-12	7/8-14	1 1/16-12
	T719-FSO-12-04	1 1/16-12	7/16-20
	T719-FSO-12-06	1 1/16-12	9/16-18
	T719-FSO-12-08	1 1/16-12	3/4-16
	T719-FSO-12-10	1 1/16-12	7/8-14
	T719-FSO-12-16	1 1/16-12	1 5/16-12
	T719-FSO-14-04	1 3/16-12	7/16-20
	T719-FSO-14-05	1 3/16-12	1/2-20
	T719-FSO-14-06	1 3/16-12	9/16-18
	T719-FSO-14-12	1 3/16-12	1 1/16-12
	T719-FSO-16-04	1 5/16-12	7/16-20
	T719-FSO-16-05	1 5/16-12	1/2-20
	T719-FSO-16-06	1 5/16-12	9/16-18
	T719-FSO-16-08	1 5/16-12	3/4-16
	T719-FSO-16-10	1 5/16-12	7/8-14
	T719-FSO-16-12	1 5/16-12	1 1/16-12
	T719-FSO-16-20	1 5/16-12	1 5/8-12
	T719-FSO-20-08	1 5/8-12	3/4-16
	T719-FSO-20-10	1 5/8-12	7/8-14
	T719-FSO-20-12	1 5/8-12	1 1/16-12
	T719-FSO-20-16	1 5/8-12	1 5/16-12
	T719-FSO-24-06	1 7/8-12	9/16-18
	T719-FSO-24-12	1 7/8-12	1 1/16-12
T719-FSO-24-16	1 7/8-12	1 5/16-12	
T719-FSO-24-20	1 7/8-12	1 5/8-12	
T719-FSO-32-24	2 1/2-12	1 7/8-12	

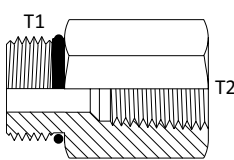

REFERENCIA	PARTE No.	O-BOSS T1	NPTF T2
T720-FSO Macho O-RING BOSS - Hembra NPTF	T720-FSO-04-02	7/16-20	1/8
	T720-FSO-04-04	7/16-20	1/4
	T720-FSO-04-06	7/16-20	3/8
	T720-FSO-05-02	1/2-20	1/8
	T720-FSO-05-04	1/2-20	1/4
	T720-FSO-06-04	9/16-18	1/4
	T720-FSO-06-06	9/16-18	3/8
	T720-FSO-08-04	3/4-16	1/4
	T720-FSO-08-06	3/4-16	3/8
	T720-FSO-08-08	3/4-16	1/2
	T720-FSO-10-04	7/8-14	1/4
	T720-FSO-10-06	7/8-14	3/8
	T720-FSO-10-08	7/8-14	1/2
	T720-FSO-10-12	7/8-14	3/4
	T720-FSO-12-06	1 1/16-12	3/8
	T720-FSO-12-08	1 1/16-12	1/2
	T720-FSO-12-12	1 1/16-12	3/4
	T720-FSO-14-12	1 3/16-12	3/4
	T720-FSO-14-16	1 3/16-12	1
	T720-FSO-16-08	1 5/16-12	1/2
	T720-FSO-16-12	1 5/16-12	3/4
	T720-FSO-16-16	1 5/16-12	1
	T720-FSO-20-16	1 5/8-12	1
	T720-FSO-20-20	1 5/8-12	1 1/4
	T720-FSO-20-24	1 5/8-12	1 1/2
	T720-FSO-24-16	1 7/8-12	1
	T720-FSO-24-20	1 7/8-12	1 1/4
T720-FSO-24-24	1 7/8-12	1 1/2	
T720-FSO-32-32	2 1/2-12	2	

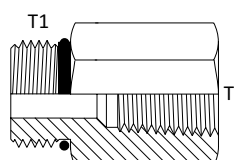

REFERENCIA	PARTE No.	O-BOSS T1	
T721-FSO Tapón Macho O-RING BOSS	T721-FSO-03	3/8-24	
	T721-FSO-04	7/16-20	
	T721-FSO-05	1/2-20	
	T721-FSO-06	9/16-18	
	T721-FSO-08	3/4-16	
	T721-FSO-10	7/8-14	
	T721-FSO-12	1 1/16-12	
	T721-FSO-14	1 3/16-12	
	T721-FSO-16	1 5/16-12	
	T721-FSO-20	1 5/8-12	
	T721-FSO-24	1 7/8-12	
	T721-FSO-32	2 1/2-12	

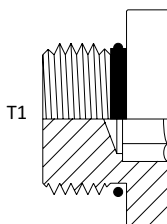

REFERENCIA	PARTE No.	JIC T1	JIC T2
T832-FS Pasamuro Macho JIC a Macho JIC	T832-FS-02	5/16-24	
	T832-FS-03	3/8-24	
	T832-FS-04	7/16-20	
	T832-FS-05	1/2-20	
	T832-FS-06	9/16-18	
	T832-FS-08	3/4-16	
	T832-FS-10	7/8-14	
	T832-FS-12	1 1/16-12	
	T832-FS-16	1 5/16-12	
	T832-FS-20	1 5/8-12	
	T832-FS-24	1 7/8-12	
	T832-FS-32	2 1/2-12	

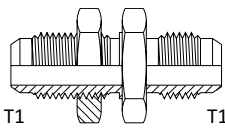

REFERENCIA	PARTE No.	JIC T1	NPTF T2	
T833-FS Codo 90° Macho JIC a Macho NPTF	T833-FS-04-04	7/16-20	1/4	
	T833-FS-06-06	9/16-18	3/8	
	T833-FS-08-06	3/4-16	3/8	
	T833-FS-08-08	3/4-16	1/2	
	T833-FS-10-08	7/8-14	1/2	

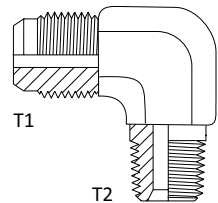

REFERENCIA	PARTE No.	JIC T1	O-BOSS T2
T833-FSO Codo 90° Macho JIC a Macho O-RING BOSS	T833-FSO-06-06	9/16-18	9/16-18
	T833-FSO-08-08	3/4-16	3/4-16
	T833-FSO-10-10	7/8-14	7/8-14

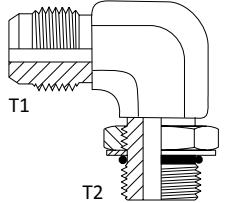

REFERENCIA	PARTE No.	JIC T1	
T839-FS Tapon Macho JIC	T839-FS-02	5/16-24	
	T839-FS-03	3/8-24	
	T839-FS-04	7/16-20	
	T839-FS-05	1/2-20	
	T839-FS-06	9/16-18	
	T839-FS-08	3/4-16	
	T839-FS-10	7/8-14	
	T839-FS-12	1 1/16-12	
	T839-FS-14	1 3/16-12	
	T839-FS-16	1 5/16-12	
	T839-FS-20	1 5/8-12	
	T839-FS-24	1 7/8-12	
	T839-FS-32	2 1/2-12	

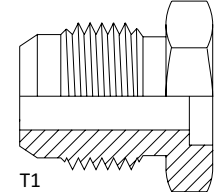

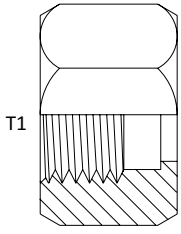
REFERENCIA	PARTE No.	JIC T1	
T841-FS Tapon Hembra JIC 	T841-FS-02	5/16-24	
	T841-FS-03	3/8-24	
	T841-FS-04	7/16-20	
	T841-FS-05	1/2-20	
	T841-FS-06	9/16-18	
	T841-FS-08	3/4-16	
	T841-FS-10	7/8-14	
	T841-FS-12	1 1/16-12	
	T841-FS-14	1 3/16-12	
	T841-FS-16	1 5/16-12	
	T841-FS-20	1 5/8-12	
	T841-FS-24	1 7/8-12	
	T841-FS-32	2 1/2-12	

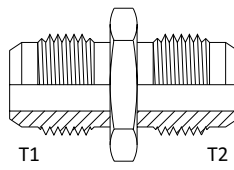
REFERENCIA	PARTE No.	JIC T1	JIC T2
T842-FS Macho JIC - Macho JIC 	T842-FS-02	5/16-24	5/16-24
	T842-FS-03	3/8-24	3/8-24
	T842-FS-04	7/16-20	7/16-20
	T842-FS-05	1/2-20	1/2-20
	T842-FS-06-04	9/16-18	7/16-20
	T842-FS-06	9/16-18	9/16-18
	T842-FS-08-06	3/4-16	9/16-18
	T842-FS-08	3/4-16	3/4-16
	T842-FS-10-06	7/8-14	9/16-18
	T842-FS-10-08	7/8-14	3/4-16
	T842-FS-10	7/8-14	7/8-14
	T842-FS-12-08	1 1/16-12	3/4-16
	T842-FS-12-10	1 1/16-12	7/8-14
	T842-FS-12	1 1/16-12	1 1/16-12
	T842-FS-14	1 3/16-12	1 3/16-12
	T842-FS-16-12	1 5/16-12	1 1/16-12
	T842-FS-16	1 5/16-12	1 5/16-12
	T842-FS-20-16	1 5/8-12	1 5/16-12
	T842-FS-20	1 5/8-12	1 5/8-12
	T842-FS-24	1 7/8-12	1 7/8-12
T842-FS-32	2 1/2-12	2 1/2-12	

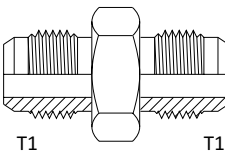
REFERENCIA	PARTE No.	JIC T1	
T842H-FS Macho JIC - Macho JIC Hexagono Largo 	T842H-FS-02	5/16-24	
	T842H-FS-03	3/8-24	
	T842H-FS-04	7/16-20	
	T842H-FS-05	1/2-20	
	T842H-FS-06	9/16-18	
	T842H-FS-08	3/4-16	
	T842H-FS-10	7/8-14	
	T842H-FS-12	1 1/16-12	
	T842H-FS-14	1 3/16-12	
	T842H-FS-16	1 5/16-12	
	T842H-FS-20	1 5/8-12	
	T842H-FS-24	1 7/8-12	
	T842H-FS-32	2 1/2-12	

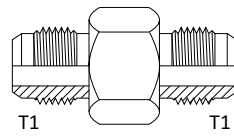
REFERENCIA	PARTE No.	JIC T1	
T842L-FS Macho JIC a Macho JIC Hexagono XLargo 	T842L-FS-03	3/8-24	
	T842L-FS-04	7/16-20	
	T842L-FS-05	1/2-20	
	T842L-FS-06	9/16-18	
	T842L-FS-08	3/4-16	
	T842L-FS-10	7/8-14	
	T842L-FS-12	1 1/16-12	
	T842L-FS-16	1 5/16-12	
	T842L-FS-20	1 5/8-12	
	T842L-FS-24	1 7/8-12	
T842L-FS-32	2 1/2-12		

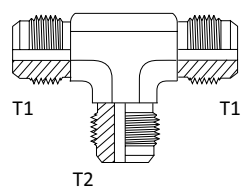
REFERENCIA	PARTE No.	JIC T1	JIC T2
T844-FS TEE Macho JIC 	T844-FS-02	5/16-24	5/16-24
	T844-FS-03	3/8-24	3/8-24
	T844-FS-04	7/16-20	7/16-20
	T844-FS-05	1/2-20	1/2-20
	T844-FS-06	9/16-18	9/16-18
	T844-FS-06-06-08	9/16-18	3/4-16
	T844-FS-06-06-10	9/16-18	7/8-14
	T844-FS-08	3/4-16	3/4-16
	T844-FS-10	7/8-14	7/8-14
	T844-FS-10-10-08	7/8-14	3/4-16
	T844-FS-12	1 1/16-12	1 1/16-12
	T844-FS-14	1 3/16-12	1 3/16-12
	T844-FS-16	1 5/16-12	1 5/16-12
	T844-FS-16-16-12	1 5/16-12	1 1/16-12
	T844-FS-20	1 5/8-12	1 5/8-12
	T844-FS-20-16-16	1 5/8-12	1 5/16-12
	T844-FS-24	1 7/8-12	1 7/8-12
	T844-FS-32	2 1/2-12	2 1/2-12

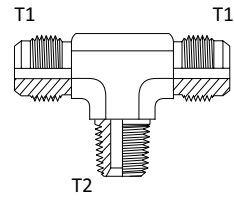
REFERENCIA	PARTE No.	JIC T1	NPTF T2
T845-FS TEE Macho JIC - Macho JIC a Macho NPTF 	T845-FS-02-02	5/16-24	1/8
	T845-FS-03-02	3/8-24	1/8
	T845-FS-04-02	7/8-20	1/8
	T845-FS-04-04	7/16-20	1/4
	T845-FS-05-02	1/2-20	1/8
	T845-FS-06-04	9/16-18	1/4
	T845-FS-08-06	3/4-16	3/8
	T845-FS-08-08	3/4-16	1/2
	T845-FS-10-08	7/8-14	1/2
	T845-FS-12-08	1 1/16-12	1/2
	T845-FS-12-12	1 1/16-12	3/4
	T845-FS-14-12	1 3/16-12	3/4
	T845-FS-16-16	1 5/16-12	1
	T845-FS-20-20	1 5/8-12	1 1/4
	T845-FS-24-24	1 7/8-12	1 1/2
	T845-FS-32-32	2 1/2-12	2

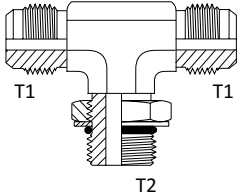
REFERENCIA	PARTE No.	JIC T1	O-BOSS T2
T845-FSO TEE Macho JIC - Macho JIC - Macho O-RING BOSS 	T845-FSO-04-04	7/16-20	7/16-20
	T845-FSO-05-05	1/2-20	1/2-20
	T845-FSO-06-06	9/16-18	9/16-18
	T845-FSO-08-08	3/4-16	3/4-16
	T845-FSO-08-08-06	3/4-16	9/16-18
	T845-FSO-10-08	7/8-14	3/4-16
	T845-FSO-10-10	7/8-14	7/8-14
	T845-FSO-12-10	1 1/16-12	7/8-14
	T845-FSO-12-12	1 1/16-12	1 1/16-12
	T845-FSO-12-16	1 1/16-12	1 5/16-12
	T845-FSO-16-16	1 5/16-12	1 5/16-12
	T845-FSO-20-20	1 5/8-12	1 5/8-12
	T845-FSO-20-20-24	1 5/8-12	1 7/8-12
	T845-FSO-24-24	1 7/8-12	1 7/8-12

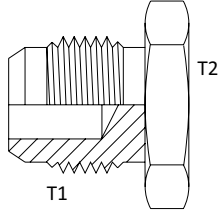
REFERENCIA	PARTE No.	JIC T1	NPTF T2
T846-FS Macho JIC a Hembra NPTF 	T846-FS-02-02	5/16-24	1/8
	T846-FS-03-02	3/8-24	1/8
	T846-FS-04-02	7/16-20	1/8
	T846-FS-04-04	7/16-20	1/4
	T846-FS-04-08	7/16-20	1/2
	T846-FS-05-02	1/2-20	1/8
	T846-FS-05-04	1/2-20	1/4
	T846-FS-06-04	9/16-18	1/4
	T846-FS-06-06	9/16-18	3/8
	T846-FS-06-08	9/16-18	1/2
	T846-FS-08-06	3/4-16	3/8
	T846-FS-08-08	3/4-16	1/2
	T846-FS-10-06	7/8-14	3/8
	T846-FS-10-08	7/8-14	1/2
	T846-FS-10-12	7/8-14	3/4
	T846-FS-12-08	1 1/16-12	1/2
	T846-FS-12-12	1 1/16-12	3/4
	T846-FS-14-12	1 3/16-12	3/4
	T846-FS-16-12	1 5/16-12	3/4
	T846-FS-16-16	1 5/16-12	1
T846-FS-20-20	1 5/8-12	1 1/4	
T846-FS-24-24	1 7/8-12	1 1/2	
T846-FS-32-32	2 1/2-12	2	

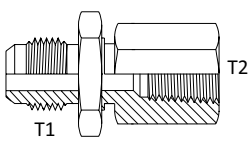
REFERENCIA	PARTE No.	JIC T1	NPTF T2
T847-FS Macho JIC con Tuerca - Hembra NPTF 	T847-FS-04-02	7/16-20	1/8
	T847-FS-04-04	7/16-20	1/4
	T847-FS-06-06	9/16-18	3/8
	T847-FS-08-06	3/4-16	3/8
	T847-FS-08-08	3/4-16	1/2
	T847-FS-10-08	7/8-14	1/2
	T847-FS-12-12	1 1/16-12	3/4
	T847-FS-16-16	1 5/16-12	1

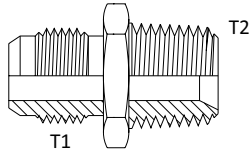
REFERENCIA	PARTE No.	JIC T1	NPTF T2
T848-FS Macho JIC a Macho NPTF 	T848-FS-02-02	5/16-24	1/8
	T848-FS-03-02	3/8-24	1/8
	T848-FS-04-02	7/16-20	1/8
	T848-FS-04-04	7/16-20	1/4
	T848-FS-04-06	7/16-20	3/8
	T848-FS-04-08	7/16-20	1/2
	T848-FS-05-02	1/2-20	1/8
	T848-FS-05-04	1/2-20	1/4
	T848-FS-05-06	1/2-20	3/8
	T848-FS-06-02	9/16-18	1/8
	T848-FS-06-04	9/16-18	1/4
	T848-FS-06-06	9/16-18	3/8
	T848-FS-06-08	9/16-18	1/2
	T848-FS-06-12	9/16-18	3/4
	T848-FS-08-04	3/4-16	1/4
	T848-FS-08-06	3/4-16	3/8
	T848-FS-08-08	3/4-16	1/2
	T848-FS-08-12	3/4-16	3/4
	T848-FS-08-16	3/4-16	1
	T848-FS-10-06	7/8-14	3/8
	T848-FS-10-08	7/8-14	1/2
	T848-FS-10-12	7/8-14	3/4
	T848-FS-12-02	1 1/16-12	1/8
	T848-FS-12-06	1 1/16-12	3/8
	T848-FS-12-08	1 1/16-12	1/2
	T848-FS-12-12	1 1/16-12	3/4
	T848-FS-12-16	1 1/16-12	1
	T848-FS-14-12	1 3/16-12	3/4
	T848-FS-16-08	1 5/16-12	1/2
	T848-FS-16-12	1 5/16-12	3/4
	T848-FS-16-16	1 5/16-12	1
	T848-FS-16-20	1 5/16-12	1 1/4
	T848-FS-20-16	1 5/8-12	1
	T848-FS-20-20	1 5/8-12	1 1/4
	T848-FS-20-24	1 5/8-12	1 1/2
	T848-FS-24-20	1 7/8-12	1 1/4
	T848-FS-24-24	1 7/8-12	1 1/2
	T848-FS-24-32	1 7/8-12	2
	T848-FS-32-24	2 1/2-12	1 1/2
	T848-FS-32-32	2 1/2-12	2

REFERENCIA	PARTE No.	JIC T1	O-BOSS T2
T848-FSO Macho JIC a Macho O-RING BOSS	T848-FSO-04-03	7/16-20	3/8-24
	T848-FSO-04-04	7/16-20	7/16-20
	T848-FSO-04-05	7/16-20	1/2-20
	T848-FSO-04-06	7/16-20	9/16-18
	T848-FSO-04-08	7/16-20	3/4-16
	T848-FSO-05-04	1/2-20	7/16-20
	T848-FSO-05-05	1/2-20	1/2-20
	T848-FSO-05-06	1/2-20	9/16-18
	T848-FSO-05-08	1/2-20	3/4-16
	T848-FSO-05-10	1/2-20	7/8-14
	T848-FSO-06-05	9/16-18	1/2-20
	T848-FSO-06-04	9/16-18	7/16-20
	T848-FSO-06-06	9/16-18	9/16-18
	T848-FSO-06-08	9/16-18	3/4-16
	T848-FSO-06-10	9/16-18	7/8-14
	T848-FSO-06-12	9/16-18	1 1/16-12
	T848-FSO-08-04	3/4-16	7/16-20
	T848-FSO-08-06	3/4-16	9/16-18
	T848-FSO-08-08	3/4-16	3/4-16
	T848-FSO-08-10	3/4-16	7/8-14
	T848-FSO-08-12	3/4-16	1 1/16-12
	T848-FSO-08-16	3/4-16	1 5/16-12
	T848-FSO-10-06	7/8-14	9/16-18
	T848-FSO-10-08	7/8-14	3/4-16
	T848-FSO-10-10	7/8-14	7/8-14
	T848-FSO-10-12	7/8-14	1 1/16-12
	T848-FSO-10-14	7/8-14	1 3/16-12
	T848-FSO-10-16	7/8-14	1 5/16-12
	T848-FSO-12-08	1 1/16-12	3/4-16
	T848-FSO-12-10	1 1/16-12	7/8-14
	T848-FSO-12-12	1 1/16-12	1 1/16-12
	T848-FSO-12-14	1 1/16-12	1 3/16-12
	T848-FSO-12-16	1 1/16-12	1 5/16-12
T848-FSO-12-20	1 1/16-12	1 5/8-12	
T848-FSO-14-12	1 3/16-12	1 1/16-12	
T848-FSO-14-14	1 3/16-12	1 3/16-12	
T848-FSO-14-16	1 3/16-12	1 5/16-12	
T848-FSO-16-08	1 5/16-12	3/4-16	
T848-FSO-16-12	1 5/16-12	1 1/16-12	
T848-FSO-16-14	1 5/16-12	1 3/16-12	
T848-FSO-16-16	1 5/16-12	1 5/16-12	
T848-FSO-16-20	1 5/16-12	1 5/8-12	
T848-FSO-16-24	1 5/16-12	1 7/8-12	
T848-FSO-20-12	1 5/8-12	1 1/16-12	
T848-FSO-20-16	1 5/8-12	1 5/16-12	
T848-FSO-20-20	1 5/8-12	1 5/8-12	
T848-FSO-20-24	1 5/8-12	1 7/8-12	
T848-FSO-24-20	1 7/8-12	1 5/8-12	
T848-FSO-24-24	1 7/8-12	1 7/8-12	
T848-FSO-32-24	2 1/2-12	1 7/8-12	
T848-FSO-32-32	2 1/2-12	2 1/2-12	

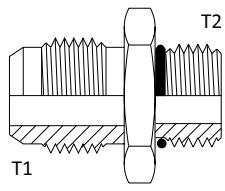

REFERENCIA	PARTE No.	JIC T1	NPTF T2
T848L-FS Macho JIC - Macho NPTF Largo	T848L-FS-04-02	7/16-20	1/8
	T848L-FS-04-04	7/16-20	1/4
	T848L-FS-05-02	1/2-20	1/8
	T848L-FS-06-06	9/16-18	3/8
	T848L-FS-08-08	3/4-16	1/2
	T848L-FS-10-08	7/8-14	1/2
	T848L-FS-12-12	1 1/16-12	3/4
	T848L-FS-16-16	1 5/16-12	1
	T848L-FS-20-20	1 5/8-12	1 1/4

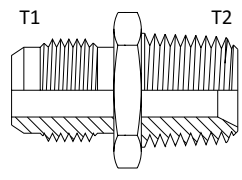

REFERENCIA	PARTE No.	JIC T1	O-BOSS T2	
T848L-FSO Macho JIC - Macho O-Ring Boss Largo	T848L-FSO-03	3/8-24	3/8-24	
	T848L-FSO-04	7/16-20	7/16-20	
	T848L-FSO-05	1/2-20	1/2-20	
	T848L-FSO-06	9/16-18	9/16-18	
	T848L-FSO-08	3/4-16	3/4-16	
	T848L-FSO-10	7/8-14	7/8-14	
	T848L-FSO-12	1 1/16-12	1 1/16-12	
	T848L-FSO-12-10	1 1/16-12	7/8-14	
	T848L-FSO-14	1 3/16-12	1 3/16-12	
	T848L-FSO-16	1 5/16-12	1 5/16-12	
	T848L-FSO-20	1 5/8-12	1 5/8-12	
	T848L-FSO-24	1 7/8-12	1 7/8-12	
	T848L-FSO-32	2 1/2-12	2 1/2-12	

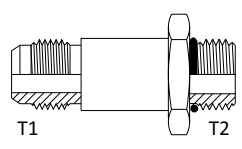

REFERENCIA	PARTE No.	JIC T1	NPTF T2
T849-FS Codo 90° Macho JIC - Macho NPTF	T849-FS-02-02	5/16-24	1/8
	T849-FS-03-02	3/8-24	1/8
	T849-FS-04-02	7/16-20	1/8
	T849-FS-04-04	7/16-20	1/4
	T849-FS-04-06	7/16-20	3/8
	T849-FS-04-08	7/16-20	1/2
	T849-FS-05-02	1/2-20	1/8
	T849-FS-05-04	1/2-20	1/4
	T849-FS-05-06	1/2-20	3/8
	T849-FS-06-02	9/16-18	1/8
	T849-FS-06-04	9/16-18	1/4
	T849-FS-06-06	9/16-18	3/8
	T849-FS-06-08	9/16-18	1/2
	T849-FS-06-12	9/16-18	3/4
	T849-FS-08-04	3/4-16	1/4
	T849-FS-08-06	3/4-16	3/8
	T849-FS-08-08	3/4-16	1/2
	T849-FS-08-12	3/4-16	3/4
	T849-FS-10-06	7/8-14	3/8
	T849-FS-10-08	7/8-14	1/2
	T849-FS-10-12	7/8-14	3/4
	T849-FS-12-06	1 1/16-12	3/8
	T849-FS-12-08	1 1/16-12	1/2
	T849-FS-12-12	1 1/16-12	3/4
	T849-FS-12-16	1 1/16-12	1
	T849-FS-14-12	1 3/16-12	3/4
	T849-FS-16-12	1 5/16-12	3/4
	T849-FS-16-16	1 5/16-12	1
	T849-FS-16-20	1 5/16-12	1 1/4
	T849-FS-20-16	1 5/8-12	1
	T849-FS-20-20	1 5/8-12	1 1/4
	T849-FS-20-24	1 5/8-12	1 1/2
	T849-FS-24-20	1 7/8-12	1 1/4
T849-FS-24-24	1 7/8-12	1 1/2	
T849-FS-32-32	2 1/2-12	2	

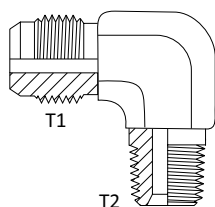

REFERENCIA	PARTE No.	JIC T1	O-BOSS T2
T849-FSO Codo 90° Macho JIC - Macho O-RING BOSS	T849-FSO-02-02	5/16-24	5/16-24
	T849-FSO-03-03	3/8-24	3/8-24
	T849-FSO-04-04	7/16-20	7/16-20
	T849-FSO-04-05	7/16-20	1/2-20
	T849-FSO-04-06	7/16-20	9/16-18
	T849-FSO-05-05	1/2-20	1/2-20
	T849-FSO-05-06	1/2-20	9/16-18
	T849-FSO-05-08	1/2-20	3/4-16
	T849-FSO-06-04	9/16-18	7/16-20
	T849-FSO-06-05	9/16-18	1/2-20
	T849-FSO-06-06	9/16-18	9/16-18
	T849-FSO-06-08	9/16-18	3/4-16
	T849-FSO-06-10	9/16-18	7/8-14
	T849-FSO-06-12	9/16-18	1 1/16-12
	T849-FSO-08-04	3/4-16	7/16-20
	T849-FSO-08-06	3/4-16	9/16-18
	T849-FSO-08-08	3/4-16	3/4-16
	T849-FSO-08-10	3/4-16	7/8-14
	T849-FSO-08-12	3/4-16	1 1/16-12
	T849-FSO-10-06	7/8-14	9/16-18
	T849-FSO-10-08	7/8-14	3/4-16
	T849-FSO-10-10	7/8-14	7/8-14
	T849-FSO-10-12	7/8-14	1 1/16-12
	T849-FSO-10-14	7/8-14	1 3/16-12
	T849-FSO-10-16	7/8-14	1 5/16-12
	T849-FSO-12-08	1 1/16-12	3/4-16
	T849-FSO-12-10	1 1/16-12	7/8-14
	T849-FSO-12-12	1 1/16-12	1 1/16-12
	T849-FSO-12-16	1 1/16-12	1 5/16-12
	T849-FSO-14-14	1 3/16-12	1 3/16-12
	T849-FSO-16-12	1 5/16-12	1 1/16-12
	T849-FSO-16-14	1 5/16-12	1 3/16-12
	T849-FSO-16-16	1 5/16-12	1 5/16-12
T849-FSO-16-20	1 5/16-12	1 5/8-12	
T849-FSO-20-16	1 5/8-12	1 5/16-12	
T849-FSO-20-20	1 5/8-12	1 5/8-12	
T849-FSO-20-24	1 5/8-12	1 7/8-12	
T849-FSO-24-24	1 7/8-12	1 7/8-12	
T849-FSO-24-16	1 7/8-12	1 5/16-12	
T849-FSO-32-32	2 1/2-12	2 1/2-12	

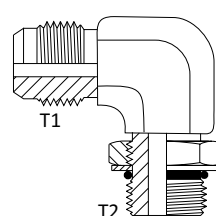

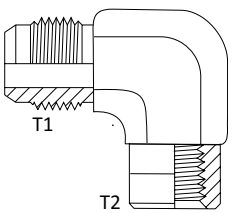
REFERENCIA	PARTE No.	JIC T1	NPTF T2
T850-FS Codo 90° Macho JIC - Hembra NPTF 	T850-FS-02-02	5/16-24	1/8
	T850-FS-03-02	3/8-24	1/8
	T850-FS-04-02	7/16-20	1/8
	T850-FS-04-04	7/16-20	1/4
	T850-FS-05-02	1/2-20	1/8
	T850-FS-05-04	1/2-20	1/4
	T850-FS-06-02	9/16-18	1/8
	T850-FS-06-04	9/16-18	1/4
	T850-FS-06-06	9/16-18	3/8
	T850-FS-08-04	3/4-16	1/4
	T850-FS-08-06	3/4-16	3/8
	T850-FS-08-08	3/4-16	1/2
	T850-FS-10-08	7/8-14	1/2
	T850-FS-12-08	1 1/16-12	1/2
	T850-FS-12-12	1 1/16-12	3/4
	T850-FS-14-12	1 3/16-12	3/4
	T850-FS-16-12	1 5/16-12	3/4
	T850-FS-16-16	1 5/16-12	1
	T850-FS-20-20	1 5/8-12	1 1/4
	T850-FS-24-24	1 7/8-12	1 1/2

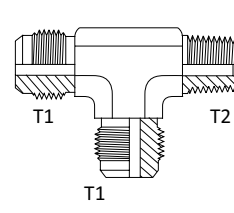
REFERENCIA	PARTE No.	JIC T1	NPTF T2	
T851-FS Tee Macho JIC - Macho NPTF - Macho JIC 	T851-FS-04-02	7/16-20	1/8	
	T851-FS-04-04	7/16-20	1/4	
	T851-FS-05-02	1/2-20	1/8	
	T851-FS-06-04	9/16-18	1/4	
	T851-FS-06-06	9/16-18	3/8	
	T851-FS-08-06	3/4-16	3/8	
	T851-FS-08-08	3/4-16	1/2	
	T851-FS-10-08	7/8-14	1/2	
	T851-FS-12-12	1 1/16-12	3/4	
	T851-FS-14-12	1 3/16-12	3/4	
	T851-FS-16-16	1 5/16-12	1	
	T851-FS-20-20	1 5/8-12	1 1/4	
	T851-FS-24-24	1 7/8-12	1 1/2	
	T851-FS-32-32	2 1/2-12	2	

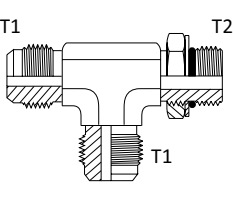
REFERENCIA	PARTE No.	JIC T1	O-BOSS T2
T851-FSO Tee Macho JIC - Macho O-RING BOSS - Macho JIC 	T851-FSO-03-03	3/8-24	3/8-24
	T851-FSO-04-04	7/16-20	7/16-20
	T851-FSO-05-05	1/2-20	1/2-20
	T851-FSO-06-06	9/16-18	9/16-18
	T851-FSO-08-08	3/4-16	3/4-16
	T851-FSO-10-10	7/8-14	7/8-14
	T851-FSO-12-12	1 1/16-12	1 1/16-12
	T851-FSO-14-14	1 3/16-12	1 3/16-12
	T851-FSO-16-16	1 5/16-12	1 5/16-12
	T851-FSO-20-20	1 5/8-12	1 5/8-12
	T851-FSO-24-24	1 7/8-12	1 7/8-12
	T851-FSO-32-32	2 1/2-12	2 1/2-12

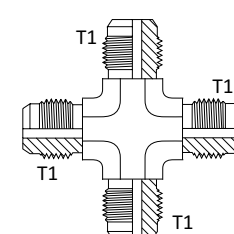
REFERENCIA	PARTE No.	JIC T1	
T852-FS Cruz Macho JIC 	T852-FS-04	7/16-20	
	T852-FS-05	1/2-20	
	T852-FS-06	9/16-18	
	T852-FS-08	3/4-16	
	T852-FS-10	7/8-14	
	T852-FS-12	1 1/16-12	
	T852-FS-14	1 3/16-12	
	T852-FS-16	1 5/16-12	
	T852-FS-20	1 5/8-12	
	T852-FS-24	1 7/8-12	
	T852-FS-32	2 1/2-12	

REFERENCIA	PARTE No.	JIC T1	NPTF T2
T854-FS Codo 45° Macho JIC a Macho NPTF	T854-FS-02-02	5/16-24	1/8
	T854-FS-03-02	3/8-24	1/8
	T854-FS-04-02	7/16-20	1/8
	T854-FS-04-04	7/16-20	1/4
	T854-FS-05-02	1/2-20	1/8
	T854-FS-05-04	1/2-20	1/4
	T854-FS-06-02	9/16-18	1/8
	T854-FS-06-04	9/16-18	1/4
	T854-FS-06-06	9/16-18	3/8
	T854-FS-06-08	9/16-18	1/2
	T854-FS-08-04	3/4-16	1/4
	T854-FS-08-06	3/4-16	3/8
	T854-FS-08-08	3/4-16	1/2
	T854-FS-08-12	3/4-16	3/4
	T854-FS-10-06	7/8-14	3/8
	T854-FS-10-08	7/8-14	1/2
	T854-FS-12-08	1 1/16-12	1/2
	T854-FS-12-12	1 1/16-12	3/4
	T854-FS-12-16	1 1/16-12	1
	T854-FS-16-12	1 5/16-12	3/4
T854-FS-16-16	1 5/16-12	1	
T854-FS-16-20	1 5/16-12	1 1/4	
T854-FS-20-20	1 5/8-12	1 1/4	
T854-FS-24-24	1 7/8-12	1 1/2	
T854-FS-32-32	2 1/2-12	2	

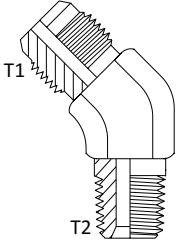

REFERENCIA	PARTE No.	JIC T1	O-BOSS T2
T854-FSO Codo 45° Macho JIC - Macho O-RING BOSS	T854-FSO-02-02	5/16-24	5/16-24
	T854-FSO-03-03	3/8-24	3/8-24
	T854-FSO-04-04	7/16-20	7/16-20
	T854-FSO-05-05	1/2-20	1/2-20
	T854-FSO-06-04	9/16-18	7/16-20
	T854-FSO-06-06	9/16-18	9/16-18
	T854-FSO-06-08	9/16-18	3/4-16
	T854-FSO-08-04	3/4-16	7/16-20
	T854-FSO-08-08	3/4-16	3/4-16
	T854-FSO-08-10	3/4-16	7/8-14
	T854-FSO-10-08	7/8-14	3/4-16
	T854-FSO-10-10	7/8-14	7/8-14
	T854-FSO-10-12	7/8-14	1 1/16-12
	T854-FSO-12-10	1 1/16-12	7/8-14
	T854-FSO-12-12	1 1/16-12	1 1/16-12
	T854-FSO-12-16	1 1/16-12	1 5/16-12
	T854-FSO-14-14	1 3/16-12	1 3/16-12
	T854-FSO-16-12	1 5/16-12	1 1/16-12
	T854-FSO-16-16	1 5/16-12	1 5/16-12
	T854-FSO-20-20	1 5/8-12	1 5/8-12
T854-FSO-24-24	1 7/8-12	1 7/8-12	

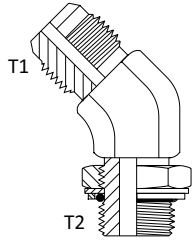

REFERENCIA	PARTE No.	JIC T1	
T854BH-FS Codo 45° Macho JIC - Macho JIC Pasamuro	T854BH-FS-04	7/16-20	
	T854BH-FS-05	1/2-20	
	T854BH-FS-06	9/16-18	
	T854BH-FS-08	3/4-16	
	T854BH-FS-10	7/8-14	
	T854BH-FS-12	1 1/16-12	
	T854BH-FS-14	1 3/16-12	
	T854BH-FS-16	1 5/16-12	
	T854BH-FS-20	1 5/8-12	
	T854BH-FS-24	1 7/8-12	
T854BH-FS-32	2 1/2-12		

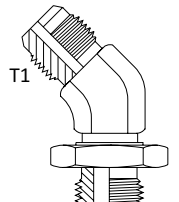

REFERENCIA	PARTE No.	JIC T1	
T855-FS Codo 90° Macho JIC - Macho JIC	T855-FS-02	5/16-24	
	T855-FS-03	3/4-24	
	T855-FS-04	7/16-20	
	T855-FS-05	1/2-20	
	T855-FS-06	9/16-18	
	T855-FS-08	3/4-16	
	T855-FS-10	7/8-14	
	T855-FS-12	1 1/16-12	
	T855-FS-14	1 3/16-12	
	T855-FS-16	1 5/16-12	
	T855-FS-20	1 5/8-12	
	T855-FS-24	1 7/8-12	
	T855-FS-32	2 1/2-12	

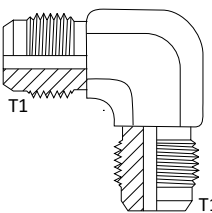

REFERENCIA	PARTE No.	JIC T1		
T855BH-FS Codo 90° Pasamuro Macho JIC - Macho JIC	T855BH-FS-04	7/16-20		
	T855BH-FS-05	1/2-20		
	T855BH-FS-06	9/16-18		
	T855BH-FS-08	3/4-16		
	T855BH-FS-10	7/8-14		
	T855BH-FS-12	1 1/16-12		
	T855BH-FS-14	1 3/16-12		
	T855BH-FS-16	1 5/16-12		
	T855BH-FS-20	1 5/8-12		
	T855BH-FS-24	1 7/8-12		
	T855BH-FS-32	2 1/2-12		

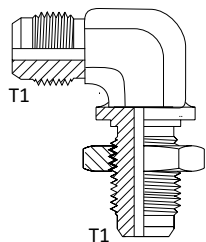

REFERENCIA	PARTE No.	JIC T1	NPTF T2	
T857-FS TEE Macho JIC - Hembra NPTF - Macho JIC	T857-FS-04-02	7/16-20	1/8	
	T857-FS-05-02	1/2-20	1/8	
	T857-FS-06-04	9/16-18	1/4	
	T857-FS-08-06	3/4-16	3/8	
	T857-FS-10-08	7/8-14	1/2	
	T857-FS-12-12	1 1/16-12	3/4	
	T857-FS-14-12	1 3/16-12	3/4	
	T857-FS-16-16	1 5/16-12	1	

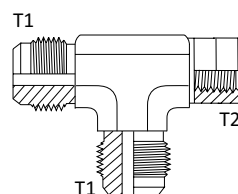

REFERENCIA	PARTE No.	JIC T1	NPTF T2
T858-FS TEE Macho JIC - Macho JIC - Hembra NPTF	T858-FS-02-02	5/16-24	1/8
	T858-FS-04-02	7/16-20	1/8
	T858-FS-04-04	7/16-20	1/4
	T858-FS-05-02	1/2-20	1/8
	T858-FS-06-04	9/16-18	1/4
	T858-FS-06-06	9/16-18	3/8
	T858-FS-08-06	3/4-16	3/8
	T858-FS-08-08	3/4-16	1/2
	T858-FS-10-08	7/8-14	1/2
	T858-FS-12-12	1 1/16-12	3/4
	T858-FS-14-12	1 3/16-12	3/4
	T858-FS-16-16	1 5/16-12	1
	T858-FS-20-20	1 5/8-12	1 1/4
	T858-FS-24-24	1 7/8-12	1 1/2

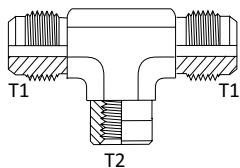

REFERENCIA	PARTE No.	JIC T1	JIC T2
T861-FS TEE Pasamuro Macho JIC	T861-FS-06-06	9/16-18	9/16-18
	T861-FS-08-08	3/4-16	3/4-16
	T861-FS-12-12	1 1/16-12	1 1/16-12

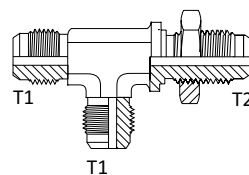

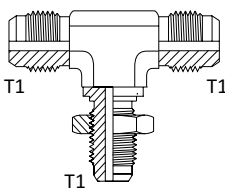
REFERENCIA	PARTE No.	JIC T1	JIC T2
T870-FS TEE Macho JIC Pasamuro 	T870-FS-04	7/16-20	
	T870-FS-05	1/2-20	
	T870-FS-06	9/16-18	
	T870-FS-08	3/4-16	
	T870-FS-10	7/8-14	
	T870-FS-12	1 1/16-12	

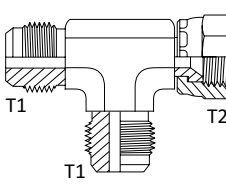
REFERENCIA	PARTE No.	JIC T1	JIC T2	
T871-FS TEE Macho JIC - Hembra JIC - Macho JIC 	T871-FS-03	3/8-24	3/8-24	
	T871-FS-04	7/16-20	7/16-20	
	T871-FS-05	1/2-20	1/2-20	
	T871-FS-06	9/16-18	9/16-18	
	T871-FS-08	3/4-16	3/4-16	
	T871-FS-10	7/8-14	7/8-14	
	T871-FS-12	1 1/16-12	1 1/16-12	
	T871-FS-14	1 3/16-12	1 3/16-12	
	T871-FS-16	1 5/16-12	1 5/16-12	
	T871-FS-20	1 5/8-12	1 5/8-12	
	T871-FS-24	1 7/8-12	1 7/8-12	

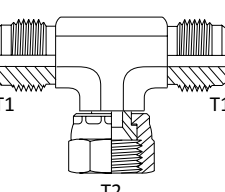
REFERENCIA	PARTE No.	JIC T1	JIC T2	
T872-FS TEE Macho JIC - Hembra JIC - Macho JIC 	T872-FS-04	7/16-20	7/16-20	
	T872-FS-05	1/2-20	1/2-20	
	T872-FS-06	9/16-18	9/16-18	
	T872-FS-08	3/4-16	3/4-16	
	T872-FS-10	7/8-14	7/8-14	
	T872-FS-12	1 1/16-12	1 1/16-12	
	T872-FS-14	1 3/16-12	1 3/16-12	
	T872-FS-16	1 5/16-12	1 5/16-12	
	T872-FS-20	1 5/8-12	1 5/8-12	
	T872-FS-24	1 7/8-12	1 7/8-12	

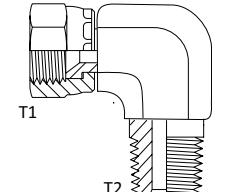
REFERENCIA	PARTE No.	JIC T1	NPTF T2
T878-FS Codo 90° Hembra JIC - Macho NPTF 	T878-FS-06-04	9/16-18	1/4
	T878-FS-08-08	3/4-16	1/2
	T878-FS-10-08	7/8-14	1/2
	T878-FS-12-12	1 1/16-12	3/4
	T878-FS-16-16	1 5/16-12	1
	T878-FS-24-24	1 7/8-12	1 1/2

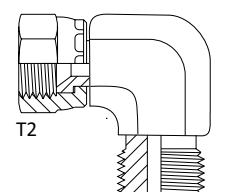
REFERENCIA	PARTE No.	JIC T1	JIC T2	
T879-FS Codo 90° Macho JIC - Hembra JIC 	T879-FS-02	5/16-24	5/16-24	
	T879-FS-03	3/8-24	3/8-24	
	T879-FS-04	7/16-20	7/16-20	
	T879-FS-05	1/2-20	1/2-20	
	T879-FS-05-06	1/2-20	9/16-18	
	T879-FS-06	9/16-18	9/16-18	
	T879-FS-08	3/4-16	3/4-16	
	T879-FS-08-06	3/4-16	9/16-18	
	T879-FS-10	7/8-14	7/8-14	
	T879-FS-10-12	7/8-14	1 1/16-12	
	T879-FS-12	1 1/16-12	1 1/16-12	
	T879-FS-14	1 3/16-12	1 3/16-12	
	T879-FS-16	1 5/16-12	1 5/16-12	
	T879-FS-20	1 5/8-12	1 5/8-12	
	T879-FS-24	7/8-12	7/8-12	
	T879-FS-32	2 1/2-12	2 1/2-12	

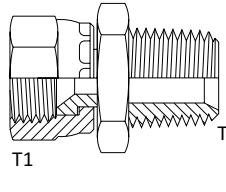
REFERENCIA	PARTE No.	NPTF T1	JIC T2	
T881-FS Hembra JIC - Macho NPTF 	T881-FS-04-04	1/4	7/16-20	
	T881-FS-06-06	3/8	9/16-18	
	T881-FS-08-06	3/8	3/4-16	
	T881-FS-08-08	1/2	3/4-16	
	T881-FS-10-08	1/2	7/8-14	
	T881-FS-12-12	3/4	1 1/16-12	
	T881-FS-16-16	1	1 5/16-12	
	T881-FS-20-20	1 1/4	1 5/8-12	

REFERENCIA	PARTE No.	JIC T1	O-BOSS T2
T881-FSO Hembra JIC - Macho O-RING BOSS	T881-FSO-04-06	7/16-20	9/16-18
	T881-FSO-06-06	9/16-18	9/16-18
	T881-FSO-06-08	9/16-18	3/4-16
	T881-FSO-12-12	1 1/16-12	1 1/16-12

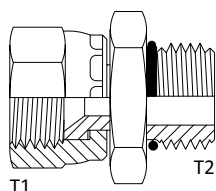

REFERENCIA	PARTE No.	JIC T1	JIC T2
T883-FS Reductor Hembra JIC - Macho JIC	T883-FS-03-04	3/8-24	7/16-20
	T883-FS-04-06	7/16-20	9/16-18
	T883-FS-05-04	1/2-20	7/16-20
	T883-FS-06-04	9/16-18	7/16-20
	T883-FS-06-05	9/16-18	1/2-20
	T883-FS-06-08	9/16-18	3/4-16
	T883-FS-08-04	3/4-16	7/16-20
	T883-FS-08-06	3/4-16	9/16-18
	T883-FS-08-10	3/4-16	7/8-14
	T883-FS-08-12	3/4-16	1 1/16-12
	T883-FS-10-04	7/8-14	7/16-20
	T883-FS-10-06	7/8-14	9/16-18
	T883-FS-10-08	7/8-14	3/4-16
	T883-FS-10-12	7/8-14	1 1/16-12
	T883-FS-12-04	1 1/16-12	7/16-20
	T883-FS-12-06	1 1/16-12	9/16-18
	T883-FS-12-08	1 1/16-12	3/4-16
	T883-FS-12-10	1 1/16-12	7/8-14
	T883-FS-12-16	1 1/16-12	1 5/16-12
	T883-FS-14-04	1 3/16-12	7/16-20
	T883-FS-14-08	1 3/16-12	3/4-16
	T883-FS-14-10	1 3/16-12	7/8-14
	T883-FS-14-12	1 3/16-12	1 1/16-12
	T883-FS-16-04	1 5/16-12	7/16-20
	T883-FS-16-08	1 5/16-12	3/4-16
	T883-FS-16-10	1 5/16-12	7/8-14
	T883-FS-16-12	1 5/16-12	1 1/16-12
	T883-FS-16-14	1 5/16-12	1 3/16-12
T883-FS-16-20	1 5/16-12	1 5/8-12	
T883-FS-20-12	1 5/8-12	1 1/16-12	
T883-FS-20-16	1 5/8-12	1 5/16-12	
T883-FS-20-24	1 5/8-12	1 7/8-12	
T883-FS-24-20	1 7/8-12	1 5/8-12	
T883-FS-24-32	1 7/8-12	2 1/2-12	
T883-FS-32-24	2 1/2-12	1 7/8-12	

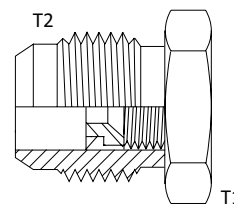

REFERENCIA	PARTE No.	JIC T1	NPTF T2
T882-FS Hembra JIC - Hembra NPTF	T882-FS-04-02	7/16-20	1/8
	T882-FS-04-04	7/16-20	1/4
	T882-FS-06-04	9/16-18	1/4
	T882-FS-06-06	9/16-18	3/8
	T882-FS-06-08	9/16-18	1/2
	T882-FS-08-08	3/4-16	1/2
	T882-FS-10-08	7/8-14	1/2
	T882-FS-12-12	1 1/16-12	3/4
	T882-FS-16-16	1 5/16-12	1
	T882-FS-20-20	1 5/8-12	1 1/4

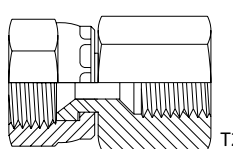

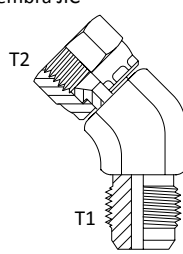
REFERENCIA	PARTE No.	JIC T1	JIC T2
T889-FS Codo 45° Macho JIC-Hembra JIC 	T889-FS-04	7/16-20	7/16-20
	T889-FS-05	1/2-20	1/2-20
	T889-FS-06	9/16-18	9/16/18
	T889-FS-08	3/4-16	3/4-16
	T889-FS-10	7/8-14	7/8-14
	T889-FS-12	1 1/16-12	1 1/16-12
	T889-FS-14	1 3/16-12	1 3/16-12
	T889-FS-16	1 5/16-12	1 5/16-12
	T889-FS-20	1 5/8-12	1 5/8-12
	T889-FS-24	1 7/8-12	1 7/8-12

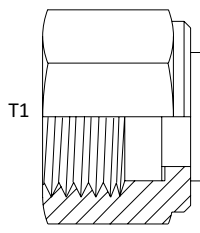
REFERENCIA	PARTE No.	ORFS T1	
T830-TT Tapon - ORFS 	T830-TT-04	9/16-18	
	T830-TT-06	11/16-16	
	T830-TT-08	13/16-16	
	T830-TT-10	1-14	
	T830-TT-12	1 3/16-12	
	T830-TT-16	1 7/16-12	
	T830-TT-20	1 11/16-12	
	T830-TT-24	2-12	

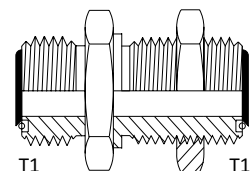
REFERENCIA	PARTE No.	ORFS T1	
T832-TT Macho ORFS - Ajuste Macho ORFS 	T832-TT-04	9/16-18	
	T832-TT-06	11/16-16	
	T832-TT-08	13/16-16	
	T832-TT-10	1-14	
	T832-TT-12	1 3/16-12	
	T832-TT-16	1 7/16-12	
	T832-TT-20	1 11/16-12	
	T832-TT-24	2-12	

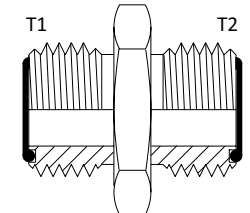
REFERENCIA	PARTE No.	ORFS T1	ORFS T2
T842-TT Macho ORFS - Macho ORFS 	T842-TT-04-04	9/16-18	9/16-18
	T842-TT-06-06	11/16-16	11/16-16
	T842-TT-08-06	13/16-16	11/16-16
	T842-TT-08-08	13/16-16	13/16-16
	T842-TT-10-08	1-14	13/16-16
	T842-TT-10-10	1-14	1-14
	T842-TT-12-12	1 3/16-12	1 3/16-12
	T842-TT-16-16	1 7/16-12	1 7/16-12
	T842-TT-20-20	1 11/16-12	1 11/16-12
	T842-TT-24-24	2-12	2-12

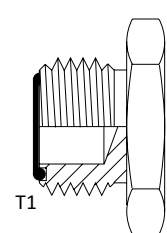
REFERENCIA	PARTE No.	ORFS T1	
T839-TT Tapón - Macho ORFS 	T839-TT-04	9/16-18	
	T839-TT-06	11/16-16	
	T839-TT-08	13/16-16	
	T839-TT-10	1-14	
	T839-TT-12	1 3/16-12	
	T839-TT-16	1 7/16-12	
	T839-TT-20	1 11/16-12	
	T839-TT-24	2-12	

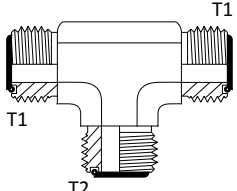
REFERENCIA	PARTE No.	ORFS T1	ORFS T2	
T844-TT TEE Macho ORFS 	T844-TT-04	9/16-18	9/16-18	
	T844-TT-06	11/16-16	11/16-16	
	T844-TT-08	13/16-16	13/16-16	
	T844-TT-10	1-14	1-14	
	T844-TT-10-10-08	1-14	13/16-16	
	T844-TT-10-10-12	1-14	1 3/16-12	
	T844-TT-12	1 3/16-12	1 3/16-12	
	T844-TT-12-12-16	1 3/16-12	1 7/16-12	
	T844-TT-16	1 7/16-12	1 7/16-12	
	T844-TT-16-16-20	1 7/16-12	1 11/16-12	
	T844-TT-20	1 11/16-12	1 11/16-12	
	T844-TT-24	2-12	2-12	

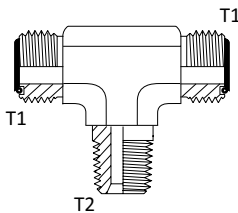
REFERENCIA	PARTE No.	ORFS T1	NPTF T2	
T845-TT TEE Macho ORFS - Macho ORFS - Macho NPTF 	T845-TT-04-04	9/16-18	1/4	
	T845-TT-06-04	11/16-16	1/4	
	T845-TT-06-06	11/16-16	3/8	
	T845-TT-08-06	13/16-16	3/8	
	T845-TT-08-08	13/16-16	1/2	
	T845-TT-10-08	1-14	1/2	
	T845-TT-12-12	1 3/16-12	3/4	
	T845-TT-16-16	1 7/16-12	1	
	T845-TT-20-20	1 11/16-12	1 1/4	
	T845-TT-24-24	2-12	1-1/2	

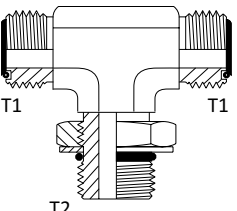
REFERENCIA	PARTE No.	ORFS T1	O-BOSS T2
T845-TTO TEE Macho ORFS - Macho ORFS - Macho O-RING BOSS 	T845-TTO-04-04	9/16-18	7/16-20
	T845-TTO-06-06	11/16-16	9/16-18
	T845-TTO-08-08	13/16-16	3/4-16
	T845-TTO-10-10	1-14	7/8-14
	T845-TTO-12-12	1 3/16-12	1 1/16-12
	T845-TTO-12-16	1 3/16-12	1 5/16-12
	T845-TTO-16-16	1 7/16-12	1 5/16-12
	T845-TTO-20-20	1 11/16-12	1 5/8-12
	T845-TTO-24-24	2-12	1 7/8-12

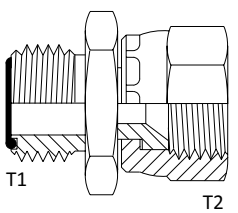
REFERENCIA	PARTE No.	ORFS T1	NPTF T2
T846-TT Macho ORFS - Hembra NPTF 	T846-TT-06-06	11/16-16	3/8
	T846-TT-08-08	13/16-16	1/2
	T846-TT-12-12	1 3/16-12	3/4
	T846-TT-16-16	1 7/16-12	1

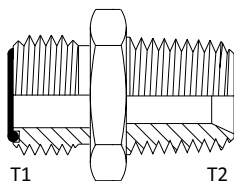
REFERENCIA	PARTE No.	ORFS T1	NPTF T2
T848-TT Macho ORFS - Macho NPTF 	T848-TT-04-02	9/16-18	1/8
	T848-TT-04-04	9/16-18	1/4
	T848-TT-04-06	9/16-18	3/8
	T848-TT-04-08	9/16-18	1/2
	T848-TT-06-04	11/16-16	1/4
	T848-TT-06-06	11/16-16	3/8
	T848-TT-06-08	11/16-16	1/2
	T848-TT-08-04	13/16-16	1/4
	T848-TT-08-06	13/16-16	3/8
	T848-TT-08-08	13/16-16	1/2
	T848-TT-08-12	13/16-16	3/4
	T848-TT-10-08	1-14	1/2
	T848-TT-10-12	1-14	3/4
	T848-TT-12-08	1 3/16-12	1/2
	T848-TT-12-12	1 3/16-12	3/4
	T848-TT-12-16	1 3/16-12	1
	T848-TT-16-12	1 7/16-12	3/4
	T848-TT-16-16	1 7/16-12	1
	T848-TT-16-20	1 7/16-12	1 1/4
	T848-TT-20-16	1 11/16-12	1
	T848-TT-20-20	1 11/16-12	1 1/4
	T848-TT-24-24	2-12	1-12

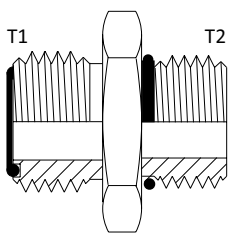
REFERENCIA	PARTE No.	ORFS T1	O-BOSS T2
T848-TTO Macho ORFS - Macho O-RING BOSS 	T848-TTO-04-02	9/16-18	5/16-24
	T848-TTO-04-04	9/16-18	7/16-20
	T848-TTO-04-06	9/16-18	9/16-18
	T848-TTO-04-08	9/16-18	3/4-16
	T848-TTO-06-04	11/16-16	7/16-20
	T848-TTO-06-06	11/16-16	9/16-18
	T848-TTO-06-08	11/16-16	3/4-16
	T848-TTO-06-10	11/16-16	7/8-14
	T848-TTO-06-12	11/16-16	1 1/16-12
	T848-TTO-08-06	13/16-16	9/16-18
	T848-TTO-08-08	13/16-16	3/4-16
	T848-TTO-08-10	13/16-16	7/8-14
	T848-TTO-08-12	13/16-16	1 1/16-12
	T848-TTO-08-14	13/16-16	1 3/16-12
	T848-TTO-08-16	13/16-16	1 5/16-12
	T848-TTO-10-06	1-14	9/16-18
	T848-TTO-10-08	1-14	3/4-16
	T848-TTO-10-10	1-14	7/8-14
	T848-TTO-10-12	1-14	1 1/16-12
	T848-TTO-10-16	1-14	1 5/16-12
	T848-TTO-12-06	1 3/16-12	9/16-18
	T848-TTO-12-08	1 3/16-12	3/4-16
	T848-TTO-12-10	1 3/16-12	7/8-14
	T848-TTO-12-12	1 3/16-12	1 1/16-12
	T848-TTO-12-14	1 3/16-12	1 3/16-12
	T848-TTO-12-16	1 3/16-12	1 5/16-12
	T848-TTO-16-10	1 7/16-12	7/8-14
	T848-TTO-16-12	1 7/16-12	1 1/16-12
	T848-TTO-16-14	1 7/16-12	1 3/16-12
	T848-TTO-16-16	1 7/16-12	1 5/16-12
	T848-TTO-16-20	1 7/16-12	1 5/8-12
	T848-TTO-16-24	1 7/16-12	1 7/8-12
T848-TTO-20-16	1 11/16-12	1 5/16-12	
T848-TTO-20-20	1 11/16-12	1 5/8-12	
T848-TTO-20-24	1 11/16-12	1 7/8-12	
T848-TTO-24-20	2-12	1 5/8-12	
T848-TTO-24-24	2-12	1 7/8-12	

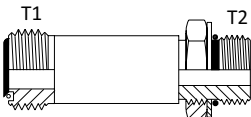
REFERENCIA	PARTE No.	ORFS T1	O-BOSS T2
T848L-TTO Macho ORFS - Macho O-RING BOSS Largo	T848L-TTO-04-04	9/16-18	7/16-20
	T848L-TTO-06-04	11/16-16	7/16-20
	T848L-TTO-06-06	11/16-16	9/16-18
	T848L-TTO-08-08	13/16-16	3/4-16
	T848L-TTO-10-10	1-14	7/8-14
	T848L-TTO-12-12	1 3/16-12	1 1/16-12
	T848L-TTO-16-16	1 7/16-12	1 5/16-12
	T848L-TTO-20-20	1 11/16-12	1 5/8-12
	T848L-TTO-24-24	2-12	1 7/8-12
			

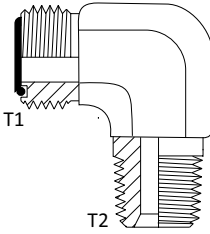
REFERENCIA	PARTE No.	ORFS T1	NPTF T2
T849-TT Codo 90° Macho ORFS - Macho NPTF	T849-TT-04-02	9/16-18	1/8
	T849-TT-04-04	9/16-18	1/4
	T849-TT-04-06	9/16-18	3/8
	T849-TT-06-04	11/16-16	1/4
	T849-TT-06-06	11/16-16	3/8
	T849-TT-06-08	11/16-16	1/2
	T849-TT-08-06	13/16-16	3/8
	T849-TT-08-08	13/16-16	1/2
	T849-TT-08-12	13/16-16	3/4
	T849-TT-10-08	1-14	1/2
	T849-TT-10-12	1-14	3/4
	T849-TT-12-08	1 3/16-12	1/2
	T849-TT-12-12	1 3/16-12	3/4
	T849-TT-12-16	1 3/16-12	1
	T849-TT-16-12	1 7/16-12	3/4
	T849-TT-16-16	1 7/16-12	1
	T849-TT-20-20	1 11/16-12	1 1/4
	T849-TT-24-24	2-12	1-12
			

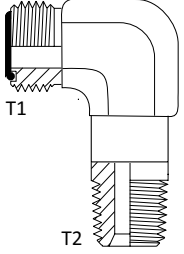
REFERENCIA	PARTE No.	ORFS T1	NPTF T2
T849L-TT Codo 90° Macho ORFS - Macho NPTF Largo	T849L-TT-16-12	1 7/16-12	3/4
			

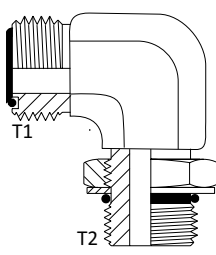
REFERENCIA	PARTE No.	ORFS T1	O-BOSS T2
T849-TTO Codo 90° Macho ORFS - Macho O-RING BOSS 	T849-TTO-04-03	9/16-18	3/8-24
	T849-TTO-04-04	9/16-18	7/16-20
	T849-TTO-04-06	9/16-18	9/16-18
	T849-TTO-04-08	9/16-18	3/4-16
	T849-TTO-06-04	11/16-16	7/16-20
	T849-TTO-06-06	11/16-16	9/16-18
	T849-TTO-06-08	11/16-16	3/4-16
	T849-TTO-06-10	11/16-16	7/8-14
	T849-TTO-06-12	11/16-16	1 1/16-12
	T849-TTO-08-06	13/16-16	9/16-18
	T849-TTO-08-08	13/16-16	3/4-16
	T849-TTO-08-10	13/16-16	7/8-14
	T849-TTO-08-12	13/16-16	1 1/16-12
	T849-TTO-10-08	1-14	3/4-16
	T849-TTO-10-10	1-14	7/8-14
	T849-TTO-10-12	1-14	1 1/16-12
	T849-TTO-10-16	1-14	1 5/16-12
	T849-TTO-12-08	1 3/16-12	3/4-16
	T849-TTO-12-10	1 3/16-12	7/8-14
	T849-TTO-12-12	1 3/16-12	1 1/16-12
	T849-TTO-12-16	1 3/16-12	1 5/16-12
	T849-TTO-16-12	1 7/16-12	1 1/16-12
	T849-TTO-16-16	1 7/16-12	1 5/16-12
	T849-TTO-16-20	1 7/16-12	1 5/8-12
	T849-TTO-20-12	1 11/16-12	1 1/16-12
	T849-TTO-20-16	1 11/16-12	1 5/16-12
	T849-TTO-20-20	1 11/16-12	1 5/8-12
T849-TTO-24-20	2-12	1 5/8-12	
T849-TTO-24-24	2-12	1 7/8-12	

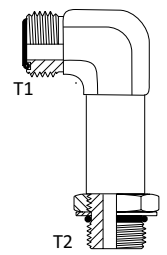
REFERENCIA	PARTE No.	ORFS T1	O-BOSS T2
T849L-TTO Codo 90° Macho ORFS - Macho O-RING BOSS Largo 	T849L-TTO-06-06	11/16-16	9/16-18
	T849L-TTO-12-12	1 3/16-12	1 1/16-12
	T849L-TTO-20-20	1 11/16-12	1 5/8-12

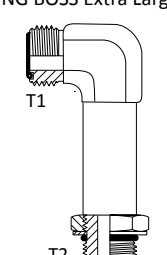
REFERENCIA	PARTE No.	ORFS T1	O-BOSS T2
T849LL-TTO Codo 90° Macho ORFS - Macho O-RING BOSS Extra Largo 	T849LL-TTO-04-04	9/16-18	7/16-20
	T849LL-TTO-10-10	1-14	7/8-14

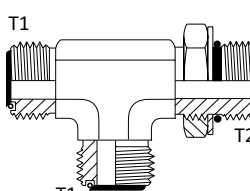
REFERENCIA	PARTE No.	ORFS T1	O-BOSS T2
T851-TTO TEE Macho ORFS - Macho O-RING BOSS a Macho ORFS 	T851-TTO-04-04	9/16-18	7/16-20
	T851-TTO-06-06	11/16-16	9/16-18
	T851-TTO-08-06-08	13/16-16	9/16-18
	T851-TTO-08-08	13/16-16	3/4-16
	T851-TTO-08-10	1-14	7/8-14
	T851-TTO-08-16-08	13/16-16	1 5/16-12
	T851-TTO-10-10	1-14	7/8-14
	T851-TTO-12-12	1 3/16-12	1 1/16-12
	T851-TTO-12-16-12	1 3/16-12	1 5/16-12
	T851-TTO-16-12-16	1 7/16-12	1 1/16-12
	T851-TTO-16-16	1 7/16-12	1 5/16-12
	T851-TTO-20-20	1 11/16-12	1 5/8-12
	T851-TTO-24-24	2-12	1 7/8-12

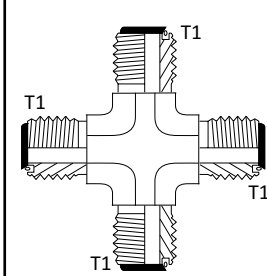
REFERENCIA	PARTE No.	ORFS T1	
T852-TT Cruz Macho ORFS 	T852-TT-06	11/16-16	
	T852-TT-08	1 3/16-16	
	T852-TT-24	2-12	

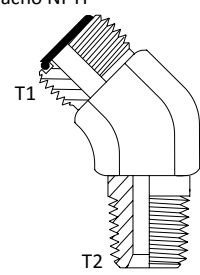
REFERENCIA	PARTE No.	ORFS T1	NPTF T2
T854-TT Codo 45° Macho ORFS - Macho NPTF 	T854-TT-04-04	9/16-18	1/4
	T854-TT-06-04	11/16-16	1/4
	T854-TT-06-06	11/16-16	3/8
	T854-TT-08-06	13/16-16	3/8
	T854-TT-08-08	13/16-16	1/2
	T854-TT-10-08	1-14	1/2
	T854-TT-12-12	1 3/16-12	3/4
	T854-TT-16-16	1 7/16-12	1
	T854-TT-20-20	1 11/16-12	1 1/4
	T854-TT-24-24	2-12	1 1/2

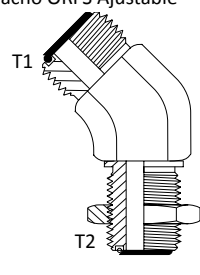
REFERENCIA	PARTE No.	ORFS T1	ORFS T2
T854BH-TT Codo 45° Macho ORFS - Macho ORFS Ajustable 	T854BH-TT-06-06	11/16-16	11/16-16
	T854BH-TT-12-12	1 3/16-12	1 3/16-12
	T854BH-TT-16-16	1 7/16-12	1 7/16-12

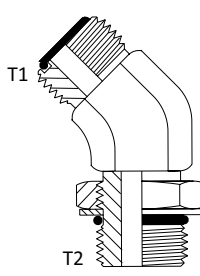
REFERENCIA	PARTE No.	ORFS T1	O-BOSS T2
T854-TTO Codo 45° Macho ORFS a Macho O-RING BOSS 	T854-TTO-04-04	9/16-18	7/16-20
	T854-TTO-04-06	9/16-18	9/16-18
	T854-TTO-06-04	11/16-16	7/16-20
	T854-TTO-06-06	11/16-16	9/16-18
	T854-TTO-06-08	11/16-16	3/4-16
	T854-TTO-08-06	13/16-16	9/16-18
	T854-TTO-08-08	13/16-16	3/4-16
	T854-TTO-08-10	13/16-16	7/8-14
	T854-TTO-10-08	1-14	3/4-16
	T854-TTO-10-10	1-14	7/8-14
	T854-TTO-10-12	1-14	1 1/16-12
	T854-TTO-12-08	1 3/16-12	3/4-16
	T854-TTO-12-10	1 3/16-12	7/8-14
	T854-TTO-12-12	1 3/16-12	1 1/16-12
	T854-TTO-12-16	1 3/16-12	1 5/16-12
	T854-TTO-16-12	1 7/16-12	1 1/16-12
	T854-TTO-16-16	1 7/16-12	1 5/16-12
T854-TTO-16-20	1 7/16-12	1 5/8-12	
T854-TTO-20-16	1 11/16-12	1 5/16-12	
T854-TTO-20-20	1 11/16-12	1 5/8-12	

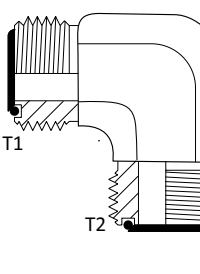
REFERENCIA	PARTE No.	ORFS T1	ORFS T2
T855-TT Codo 90° Macho ORFS - Macho ORFS 	T855-TT-04-04	9/16-18	9/16-18
	T855-TT-06-06	11/16-16	11/16-16
	T855-TT-08-08	13/16-16	13/16-16
	T855-TT-10-10	1-14	1-14
	T855-TT-12-12	1 3/16-12	1 3/16-12
	T855-TT-12-10	1 3/16-12	1/14
	T855-TT-16-16	1 7/16-12	1 7/16-12
	T855-TT-20-20	1 11/16-12	1 11/16-12
	T855-TT-24-24	2-12	2-12

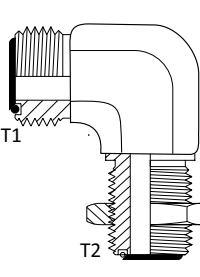
REFERENCIA	PARTE No.	ORFS T1	ORFS T2
T855BH-TT Codo 90° Macho ORFS a Macho ORFS Ajustable 	T855BH-TT-04	9/16-18	9/16-18
	T855BH-TT-06	11/16-16	11/16-16
	T855BH-TT-08	13/16-16	13/16-16
	T855BH-TT-10	1-14	1-14
	T855BH-TT-12	1 3/16-12	1 3/16-12
	T855BH-TT-16	1 7/16-12	1 7/16-12

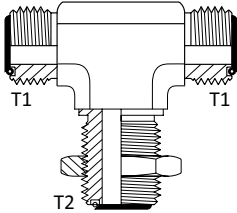
REFERENCIA	PARTE No.	ORFS T1	ORFS T2
T870-TT TEE Macho ORFS - Macho ORFS - Macho ORFS Largo 	T870-TT-04	9/16-18	9/16-18
	T870-TT-06	11/16-16	11/16-16
	T870-TT-08	13/16-16	13/16-16
	T870-TT-10	1-14	1-14
	T870-TT-12	1 3/16-12	1 3/16-12

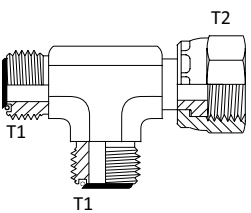
REFERENCIA	PARTE No.	ORFS T1	ORFS T2
T871-TT TEE Macho ORFS a Hembra ORFS - Macho ORFS 	T871-TT-04	9/16-18	9/16-18
	T871-TT-06	11/16-16	11/16-16
	T871-TT-08	13/16-16	13/16-16
	T871-TT-12	1 3/16-12	1 3/16-12
	T871-TT-16	1 7/16-12	1 7/16-12
	T871-TT-20	1 11/16-12	1 11/16-12
	T871-TT-24	2-12	2-12

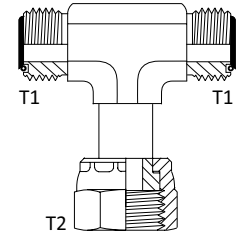
REFERENCIA	PARTE No.	ORFS T1	ORFS T2	
T872-TT TEE Macho ORFS - Macho ORFS - Hembra ORFS 	T872-TT-04	9/16-18	9/16-18	
	T872-TT-06	11/16-16	11/16-16	
	T872-TT-08	13/16-16	13/16-16	
	T872-TT-10	1-14	1-14	
	T872-TT-12	1 3/16-12	1 3/16-12	
	T872-TT-16	1 7/16-12	1 7/16-12	
	T872-TT-20	1 11/16-12	1 11/16-12	
	T872-TT-24	2-12	2-12	

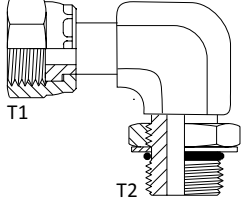
REFERENCIA	PARTE No.	ORFS T1	O-BOSS T2
T878-TTO Codo 90° Hembra ORFS - Macho O-RING BOSS Ajustable 	T878-TTO-06-06	11/16-16	9/16-18
	T878-TTO-16-16	1 7/16-12	1 5/16-12
	T878-TTO-24-24	2-12	1 7/8-12

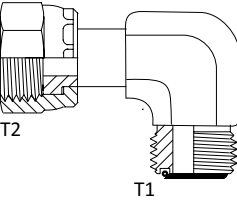
REFERENCIA	PARTE No.	ORFS T1	ORFS T2
T879-TT Codo 90° Hembra ORFS - Macho ORFS 	T879-TT-04	9/16-18	9/16-18
	T879-TT-04-08	9/16-18	13/16-16
	T879-TT-06	11/16-16	11/16-16
	T879-TT-06-08	11/16-16	13/16-16
	T879-TT-08	13/16-16	13/16-16
	T879-TT-10	1-14	1-14
	T879-TT-12	1 3/16-12	1 3/16-12
	T879-TT-10-16	1-14	1-7/16-12
	T879-TT-16	1 7/16-12	1 7/16-12
	T879-TT-16-20	1 7/16-12	1 11/16-12
	T879-TT-20-16	1 11/16-12	1 7/16-12
	T879-TT-20	1 11/16-12	1 11/16-12
	T879-TT-24	2-12	2-12

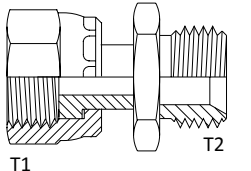
REFERENCIA	PARTE No.	ORFS T1	NPTF T2
T881-TT Hembra ORFS - Macho NPTF 	T881-TT-06-06	11/16-16	3/8
	T881-TT-08-08	13/16-16	1/2
	T881-TT-10-08	1-14	1/2
	T881-TT-12-12	1 3/16-12	3/4

REFERENCIA	PARTE No.	ORFS T1	O-BOSS T2
T881-TTO Hembra ORFS - Macho O-RING BOSS	T881-TTO-08-12	13/16-16	1 1/16-12
	T881-TTO-24-24	2-12	1 7/8-12

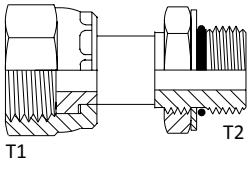

REFERENCIA	PARTE No.	ORFS T1	NPTF T2
T882-TT Hembra ORFS - Hembra NPTF	T882-TT-06-02	11/16-16	1/8

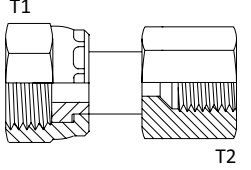

REFERENCIA	PARTE No.	ORFS T1	ORFS T2
T883-TT Hembra ORFS - Macho ORFS Reductor	T883-TT-06-04	11/16-16	9/16-18
	T883-TT-06-08	11/16-16	13/16-16
	T883-TT-08-04	13/16-16	9/16-18
	T883-TT-08-06	13/16-16	11/16-18
	T883-TT-10-08	1-14	13/16-16
	T883-TT-12-04	1 3/16-12	9/16-18
	T883-TT-12-06	1 3/16-12	11/16-16
	T883-TT-12-08	1 3/16-12	13/16-16
	T883-TT-12-10	1 3/16-12	1-14
	T883-TT-16-06	1 7/16-12	11/16-16
	T883-TT-16-08	1 7/16-12	13/16-16
	T883-TT-16-10	1 7/16-12	1-14
	T883-TT-20-12	1 11/16-12	1 3/16-12
	T883-TT-20-16	1 11/16-12	1 7/16-12
	T883-TT-24-12	2-12	1 3/16-12
	T883-TT-24-16	2-12	1 7/16-12
T883-TT-24-20	2-12	1 11/16-12	

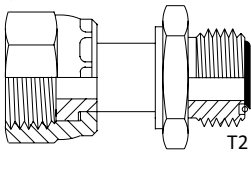

REFERENCIA	PARTE No.	ORFS T1	ORFS T2
T889-TT Codo 45° Hembra ORFS- Macho ORFS	T889-TT-04	9/16-18	9/16-18
	T889-TT-06	11/16-16	11/16-16
	T889-TT-08	13/16-16	13/16-16
	T889-TT-10	1-14	1-14
	T889-TT-12	1 3/16-12	1 3/16-12
	T889-TT-16	1 7/16-12	1 7/16-12
	T889-TT-24	2-12	2-12

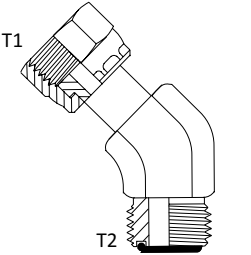

REFERENCIA	PARTE No.	BSPT T1	
T964 Tapón Macho BSPT	T964-02	1/8	
	T964-04	1/4	
	T964-06	3/8	
	T964-08	1/2	
	T964-12	3/4	
	T964-16	1	
	T964-20	1 1/4	
	T964-24	1 1/2	
	T964-32	2	

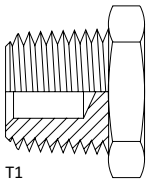

REFERENCIA	PARTE No.	BSPP T1	
T973 Tapón Macho BSPP con O-RING	T973-02	1/8	
	T973-04	1/4	
	T973-06	3/8	
	T973-08	1/2	
	T973-12	3/4	
	T973-16	1	
	T973-20	1 1/4	
	T973-24	1 1/2	
	T973-32	2	

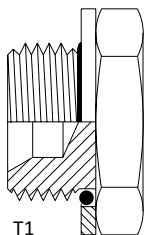

REFERENCIA	PARTE No.	DIN T1	
T973M Tapón Macho DIN	T973M-12-15	12x1 5	
	T973M-14-15	14x1 5	
	T973M-16-15	16x1 5	
	T973M-18-15	18x1 5	
	T973M-20-15	20x1 5	
	T973M-22-15	22x1 5	
	T973M-24-15	24x1 5	
	T973M-26-15	26x1 5	
	T973M-27-20	27x2	
	T973M-28-15	28x1 5	
	T973M-30-20	30x2	
	T973M-33-20	33x2	
	T973M-36-20	36x2	
	T973M-42-20	42x2	
	T973M-52-20	52x2	

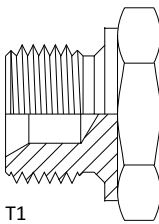

REFERENCIA	PARTE No.	BSPP T1	
T959 Tapón Hembra BSPP Giratoria	T959-02	1/8	
	T959-04	1/4	
	T959-06	3/8	
	T959-08	1/2	
	T959-12	3/4	
	T959-16	1	
	T959-20	1 1/4	
	T959-24	1 1/2	
	T959-32	2	

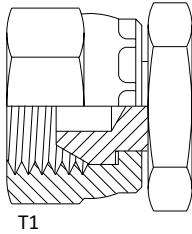

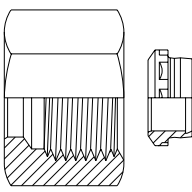
REFERENCIA	PARTE No.	DIN SL T1	
T906ML Tapón Hembra DIN S.L.  <p style="text-align: center;">T1</p>	T906ML-12-15	12x1 5	
	T906ML-14-15	14x1 5	
	T906ML-16-15	16x1 5	
	T906ML-18-15	18x1 5	
	T906ML-22-15	22x1 5	
	T906ML-26-15	26x1 5	
	T906ML-30-20	30x2 0	
	T906ML-36-20	36x2 0	

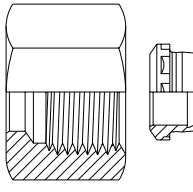
REFERENCIA	PARTE No.	DIN SP T1	
T906MS Tapón Hembra DIN S.P.  <p style="text-align: center;">T1</p>	T906MS-14-15	14x1 5	
	T906MS-16-15	16x1 5	
	T906MS-18-15	18x1 5	
	T906MS-20-15	20x1 5	
	T906MS-22-15	22x1 5	
	T906MS-24-15	24x1 5	
	T906MS-30-20	30x2	
	T906MS-36-20	36x2	
	T906MS-42-20	42x2	
	T906MS-52-20	52x2	

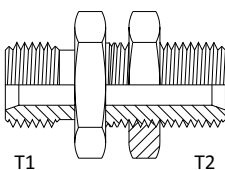
REFERENCIA	PARTE No.	BSPP T1	BSPP T2
T944 Pasamuro Macho BSPP - Macho BSPP  <p style="text-align: center;">T1 T2</p>	T944-04-04	1/4	1/4
	T944-06-06	3/8	3/8
	T944-08-08	1/2	1/2
	T944-12-12	3/4	3/4
	T944-16-16	1	1
	T944-20-20	1.1/4	1.1/4

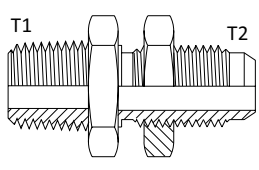
REFERENCIA	PARTE No.	BSPTM T1	JIC T2
T9130 Pasamuro Macho BSPTM - Macho JIC  <p style="text-align: center;">T1 T2</p>	T9130-08-12	1/2	1.1/16

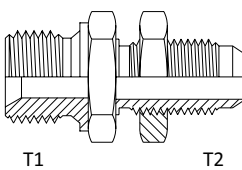
REFERENCIA	PARTE No.	BSPP T1	JIC T2
T9130P Pasamuro Macho BSPP - Macho JIC  <p style="text-align: center;">T1 T2</p>	T9130P-0606	3/8	9/16
	T9130P-0808	1/2	3/4
	T9130P-0814	1/2	7/8

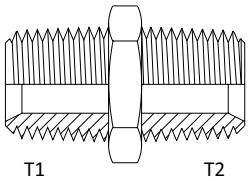
REFERENCIA	PARTE No.	BSPT T1	BSPT T2
T927 Macho BSPT - Macho BSPT 	T927-02-02	1/8	1/8
	T927-04-02	1/4	1/8
	T927-04-04	1/4	1/4
	T927-06-04	3/8	1/4
	T927-06-06	3/8	3/8
	T927-08-04	1/2	1/4
	T927-08-06	1/2	3/8
	T927-08-08	1/2	1/2
	T927-10-08	5/8	1/2
	T927-10-10	5/8	5/8
	T927-12-06	3/4	3/8
	T927-12-08	3/4	1/2
	T927-12-10	3/4	5/8
	T927-12-12	3/4	3/4
	T927-16-08	1	1/2
	T927-16-12	1	3/4
	T927-16-16	1	1
	T927-20-12	1.1/4	3/4
	T927-20-16	1.1/4	1
	T927-20-20	1.1/4	1.1/4
	T927-24-12	1.1/2	1
	T927-24-16	1.1/2	1
	T927-24-20	1.1/2	1.1/4
	T927-24-24	1.1/2	1.1/2
	T927-32-20	2	1,1/4
	T927-32-24	2	1,1/2
	T927-32-32	2	2

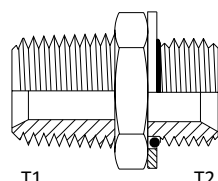
REFERENCIA	PARTE No.	BSPT T1	BSPP O-RING T2
T975 Macho BSPT - Macho BSPP O-RING 	T975-04-04	1/4	1/4
	T975-04-06	1/4	3/8
	T975-04-08	1/4	1/2
	T975-06-04	3/8	1/4
	T975-06-06	3/8	3/8
	T975-06-08	3/8	1/2
	T975-08-04	1/2	1/4
	T975-08-06	1/2	3/8
	T975-08-08	1/2	1/2
	T975-08-10	1/2	5/8
	T975-08-12	1/2	3/4
	T975-12-08	3/4	1/2
	T975-12-12	3/4	3/4
	T975-12-16	3/4	1
	T975-16-12	1	3/4
	T975-16-16	1	1
	T975-16-20	1	1.1/4
	T975-20-20	1.1/4	1.1/4
	T975-24-24	1.1/2	1.1/2
	T975-32-32	2	2

REFERENCIA	PARTE No.	BSPP T1	BSPP O-RING T2
T946 Macho BSPP - Macho BSPP O-RING	T946-04-04	1/4	1/4
	T946-04-06	1/4	3/8
	T946-06-06	3/8	3/8
	T946-06-08	3/8	1/2
	T946-08-04	1/2	1/4
	T946-08-08	1/2	1/2
	T946-08-12	1/2	3/4
	T946-12-12	3/4	3/4
	T946-12-16	3/4	1
	T946-16-16	1	1
	T946-20-20	1.1/4	1.1/4
	T946-20-24	1.1/4	1.1/2
	T946-24-24	1.1/2	1.1/2
	T946-32-32	2	2

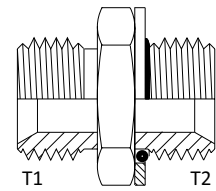

REFERENCIA	PARTE No.	BSPP O-RING T1	JIC T2
T974 Macho BSPP O-RING - Macho JIC	T974-02-04	1/8	7/16
	T974-02-06	1/8	9/16
	T974-04-04	1/4	7/16
	T974-04-05	1/4	1/2
	T974-04-06	1/4	9/16
	T974-04-08	1/4	3/4
	T974-04-12	1/4	1.1/16
	T974-06-04	3/8	7/16
	T974-06-06	3/8	9/16
	T974-06-08	3/8	3/4
	T974-06-10	3/8	7/8
	T974-06-12	3/8	1.1/16
	T974-08-06	1/2	9/16
	T974-08-08	1/2	3/4
	T974-08-10	1/2	7/8
	T974-08-12	1/2	1.1/16
	T974-12-06	3/4	9/16
	T974-12-08	3/4	3/4
	T974-12-10	3/4	7/8
	T974-12-12	3/4	1.1/16
	T974-12-16	3/4	1.5/16
	T974-12-20	3/4	1.5/8
	T974-16-12	1	1.1/16
	T974-16-16	1	1.5/16
	T974-16-20	1	1.5/8
	T974-20-12	1.1/4	1.1/16
	T974-20-16	1.1/4	1.5/16
	T974-20-20	1.1/4	1.5/8
	T974-24-12	1.1/2	1.1/16
	T974-24-16	1.1/2	1.5/16
	T974-24-20	1.1/2	1.5/8
	T974-24-24	1.1/2	1.7/8
T974-32-32	2	2.1/2	

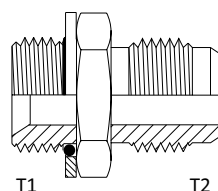

REFERENCIA	PARTE No.	BSPP T1	ORFS T2
T9180 Macho BSPP - Macho ORFS	T9180-04-06	1/4	11/16
	T9180-06-06	3/8	11/16
	T9180-06-08	3/8	13/16
	T9180-08-08	1/2	13/16

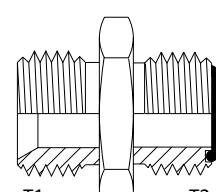

REFERENCIA	PARTE No.	BSPT T1	O-BOSS T2
T993 Macho BSPT - Macho O-RING BOSS	T993-04-06	1/4	9/16
	T993-04-08	1/4	3/4
	T993-04-10	1/4	7/8
	T993-06-06	3/8	9/16
	T993-06-08	3/8	3/4
	T993-06-10	3/8	7/8
	T993-06-12	3/8	1.1/16
	T993-08-06	1/2	9/16
	T993-08-08	1/2	3/4
	T993-08-10	1/2	7/8
	T993-08-12	1/2	1.1/16
	T993-10-10	5/8	7/8
	T993-10-12	5/8	1.1/16
	T993-12-08	3/4	3/4
	T993-12-10	3/4	7/8
	T993-12-12	3/4	1.1/16
	T993-12-16	3/4	1.5/16
	T993-12-20	3/4	1.5/8
	T993-16-12	1	1.1/16
	T993-16-16	1	1.5/16
	T993-16-20	1	1.5/8
	T993-20-16	1.1/4	1.5/16
	T993-20-16	1.1/4	1.5/8
T993-24-20	1.1/2	1.5/8	
T993-24-24	1.1/2	1.7/8	

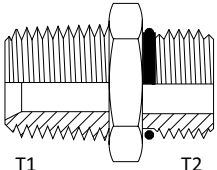

REFERENCIA	PARTE No.	BSPP O-RING T1	DIN SL T2
T975ML Macho BSPP O-RING - Macho DIN S.L.	T975ML-04-14	1/4	14x1 5
	T975ML-01-88	1/2	18x1 5
	T975ML-12-22	3/4	22x1 5

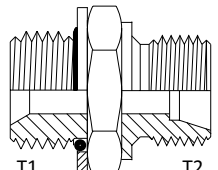

REFERENCIA	PARTE No.	BSPP O-RING T1	DIN SP T2
T975MS Macho BSPP O-RING - Macho DIN S.P.	T975MS-04-16	1/4	16x1 5
	T975MS-02-18	1/8	18x1 5
	T975MS-04-18	1/4	18x1 5
	T975MS-06-18	3/8	18x1 5
	T975MS-06-20	3/8	20x1 5
	T975MS-08-22	1/2	22x1 5
	T975MS-06-24	3/8	24x1 5
	T975MS-08-24	1/2	24x1 5
	T975MS-12-30	3/4	30x2 0
	T975MS-12-36	3/4	36x2 0
	T975MS-16-36	1	36x2 0
	T975MS-20-42	1.1/4	42x2 0
	T975MS-24-52	1.1/2	52x2 0

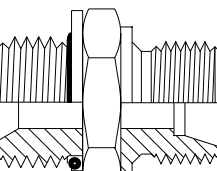

REFERENCIA	PARTE No.	JIC T1	DIN SL T2
T907ML Macho JIC - Macho DIN S.L.	TTML-12-04	7/16	12x1 5
	T907ML-12-06	9/16	12x1 5
	T907ML-14-06	9/16	14x1 5
	T907ML-14-08	3/4	14x1 5
	T907ML-16-04	7/16	16x1 5
	T907ML-18-06	9/16	18x1 5
	T907ML-18-08	3/4	18x1 5
	T907ML-22-08	3/4	22x1 5
	T907ML-22-10	7/8	22x1 5

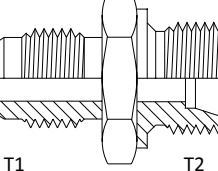

REFERENCIA	PARTE No.	JIC T1	DIN SP T2
T907MS Macho JIC - Macho DIN S.P.	T907MS-18-06	9/16	18x1,5
	T907MS-24-08	3/4	24x1,5
	T907MS-24-12	1.1/16	24x1,5
	T907MS-30-10	7/8	30x2
	T907MS-36-12	1.1/16	36x2
	T907MS-42-16	1.5/16	36x2

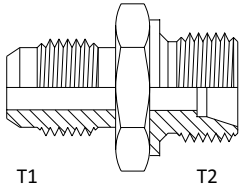

REFERENCIA	PARTE No.	BSPT T1	BSPT T2
T924 Bushing Macho BSPT- Hembra BSPT	T924-04-02	1/4	1/8
	T924-06-02	3/8	1/8
	T924-06-04	3/8	1/4
	T924-08-04	1/2	1/4
	T924-08-06	1/2	3/8
	T924-12-04	3/4	1/4
	T924-12-06	3/4	3/8
	T924-12-08	3/4	1/2
	T924-16-06	1	3/8
	T924-16-08	1	1/2
	T924-16-12	1	3/4
	T924-20-08	1.1/4	1/2
	T924-20-12	1.1/4	3/4
	T924-20-16	1.1/4	1
	T924-24-08	1.1/2	1/2
	T924-24-12	1.1/2	3/4
	T924-24-16	1.1/2	1
	T924-24-20	1.1/2	1.1/4
	T924-32-16	2	1
	T924-32-24	2	1.1/2

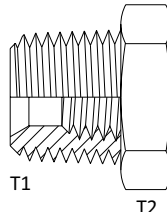

REFERENCIA	PARTE No.	BSP O-RING T1	BSPT T2
T9102 Bushing Macho BSP O-RING - Hembra BSPT	T9102-04-02	1/4	1/8
	T9102-06-02	3/8	1/8
	T9102-06-04	3/8	1/4
	T9102-08-04	1/2	1/4
	T9102-08-06	1/2	3/8
	T9102-12-04	3/4	1/4
	T9102-12-06	3/4	3/8
	T9102-12-08	3/4	1/2
	T9102-16-08	1	1/2
	T9102-16-12	1	3/4
	T9102-20-12	1.1/4	3/4
	T9102-20-16	1.1/4	1
	T9102-24-16	1.1/2	1
	T9102-24-20	1.1/2	1.1/4

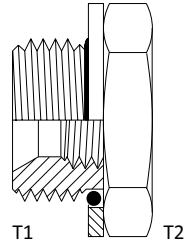

REFERENCIA	PARTE No.	O-BOSS T1	BSPT T2
T985 Bushing Macho O-RING BOSS - Hembra BSPT	T985-02-06	9/16	1/8
	T985-02-08	3/4	1/8
	T985-02-10	1.1/16	1/8
	T985-04-08	3/4	1/4
	T985-04-10	7/8	1/4
	T985-04-12	1.1/16	1/4
	T985-04-16	1.5/16	1/4
	T985-06-10	7/8	3/8
	T985-06-12	1.1/16	3/8
	T985-06-16	1.5/16	3/8
	T985-08-10	7/8	1/2
	T985-08-12	1.1/16	1/2
	T985-08-16	1.5/16	1/2
	T985-08-20	1.5/8	1/2
	T985-12-16	1.5/16	3/4
	T985-12-20	1.5/8	3/4
	T985-16-26	1.5/8	1

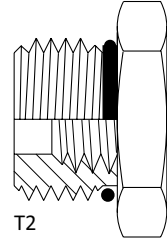

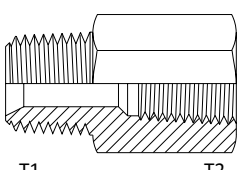
REFERENCIA	PARTE No.	BSPT T1	BSPT T2
T972 Macho BSPT - Hembra BSPT Fija 	T972-02-02	1/8	1/8
	T972-02-04	1/8	1/4
	T972-04-04	1/4	1/4
	T972-04-06	1/4	3/8
	T972-06-06	3/8	3/8
	T972-06-08	3/8	1/2
	T972-08-08	1/2	1/2
	T972-08-12	1/2	3/4
	T972-12-12	3/4	3/4
	T972-16-16	1	1

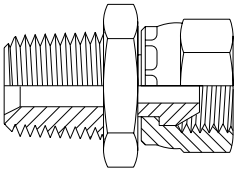
REFERENCIA	PARTE No.	BSPT T1	BSPP T2
T980 Macho BSPT - Hembra BSPP "G" 	T980-02-02	1/8	1/8
	T980-04-04	1/4	1/4
	T980-06-06	3/8	3/8
	T980-06-08	3/8	1/2
	T980-08-06	1/2	3/8
	T980-08-08	1/2	1/2
	T980-08-12	1/2	3/4
	T980-12-12	3/4	3/4
	T980-12-16	3/4	1
	T980-16-12	1	3/4
	T980-16-16	1	1
T980-20-20	1.1/4	1.1/4	

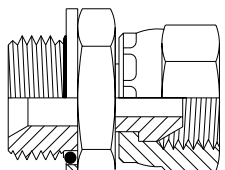
REFERENCIA	PARTE No.	BSPP O-RING T1	BSPP T2
T943 Macho BSPP O-RING - Hembra BSPP "G" 	T943-02-02	1/8	1/8
	T943-04-04	1/4	1/4
	T943-06-06	3/8	3/8
	T943-06-08	3/8	1/2
	T943-08-06	1/2	3/8
	T943-08-08	1/2	1/2
	T943-12-12	3/4	3/4
	T943-16-16	1	1
	T943-20-20	1.1/4	1.1/4

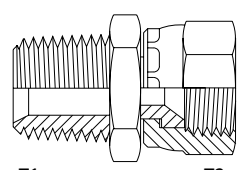
REFERENCIA	PARTE No.	BSPT T1	JIC T2
T961 Macho BSPT - Hembra JIC "G" 	T961-04-04	1/4	7/16
	T961-04-06	1/4	9/16
	T961-06-06	3/8	9/16
	T961-06-08	3/8	3/4
	T961-06-10	3/8	7/8
	T961-08-08	1/2	3/4
	T961-08-12	1/2	7/8
	T961-12-17	3/4	1.1/16
	T961-16-21	1	1.5/16
	T961-24-26	1.1/2	1.5/8

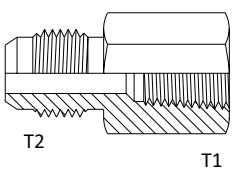
REFERENCIA	PARTE No.	BSPT T1	JIC T2
T916 Macho JIC - Hembra BSPT Fija 	T916-02-04	1/8	7/16
	T916-02-06	1/8	9/16
	T916-04-06	1/4	9/16
	T916-06-08	3/8	3/4
	T916-08-06	1/2	9/16
	T916-08-08	1/2	3/4
	T916-08-10	1/2	7/8
	T916-08-12	1/2	1.1/16
	T916-12-12	3/4	1.1/16

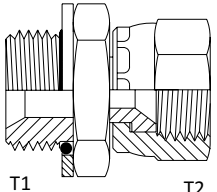
REFERENCIA	PARTE No.	BSPP O-RING T1	JIC T2
T971 Macho BSPP O-RING - Hembra JIC "G" 	T971-04-06	1/4	9/16
	T971-06-06	3/8	9/16
	T971-06-08	3/8	3/4
	T971-06-10	3/8	7/8
	T971-08-05	1/2	1/2
	T971-08-08	1/2	3/4
	T971-08-10	1/2	7/8
	T971-12-06	3/4	9/16
	T971-12-08	3/4	3/4
	T971-12-10	3/4	7/8
	T971-12-12	3/4	1.1/16
	T971-16-12	1	1.1/16
	T971-16-16	1	1.5/16
	T971-20-20	1.1/4	1.5/16

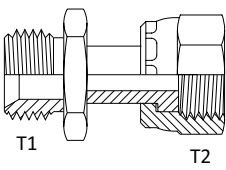
REFERENCIA	PARTE No.	BSPP O-RING T1	ORFS T2
T9181 Macho BSPP O-RING - Hembra ORFS "G" 	T9181-04-06	1/4	11/16
	T9181-06-06	3/8	11/16
	T9181-06-08	3/8	13/16
	T9181-08-08	1/2	13/16

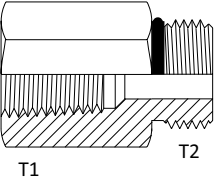
REFERENCIA	PARTE No.	BSPT T1	O-BOSS T2
T996 Hembra BSPT - Macho O-RING BOSS "F" 	T96-04-06	1/4	9/16
	T96-06-08	3/8	3/4
	T96-08-08	1/2	3/4
	T96-08-10	1/2	7/8

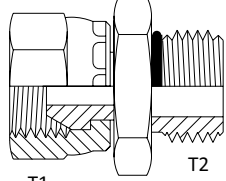
REFERENCIA	PARTE No.	BSPP T1	O-BOSS T2
T995 Hembra BSPP - Macho O-RING BOSS "G" 	T995-04-06	1/4	9/16
	T995-06-08	3/8	3/4
	T995-06-10	3/8	7/8
	T995-08-08	1/2	3/4
	T995-08-10	1/2	7/8
	T995-12-10	3/4	7/8
	T995-12-12	3/4	1.1/16
	T995-16-16	1	1.5/16

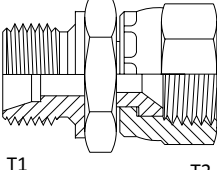
REFERENCIA	PARTE No.	DIN S.L T1	JIC G T2
T971ML Macho DIN S.L. - Hembra JIC "G" 	T971ML-18-06	18x1,5	9/16

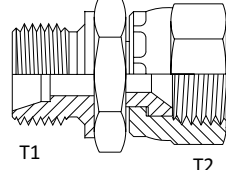
REFERENCIA	PARTE No.	DIN S.P T1	JIC T2
T971MS Macho DIN S.P. - Hembra JIC "G" 	T971MS-18-04	18x1,5	7/16
	T971MS-18-06	18x1,5	9/16
	T971MS-24-08	24x1,5	3/4
	T971MS-30-12	30x2	1.1/16

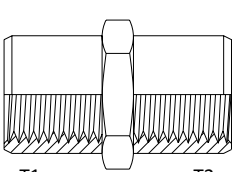
REFERENCIA	PARTE No.	BSPT T1	BSPT T2
T926 Unión Hembra BSPT 	T926-02-02	1/8	1/8
	T926-04-04	1/4	1/4
	T926-06-04	3/8	1/4
	T926-06-06	3/8	3/8
	T926-08-04	1/2	1/4
	T926-08-06	1/2	3/8
	T926-08-08	1/2	1/2
	T926-12-04	3/4	1/4
	T926-12-08	3/4	1/2
	T926-12-12	3/4	3/4
	T926-16-12	1	3/4
	T926-16-16	1	1
	T926-20-20	1.1/4	1.1/4
	T926-24-24	1.1/2	1.1/2
T926-32-32	2	2	

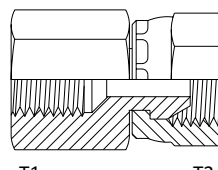
REFERENCIA	PARTE No.	BSPT T1	BSPP T2
T981 Hembra BSPT - Hembra BSPP "G" 	T981-04-04	1/4	1/4
	T981-06-06	3/8	3/8
	T981-08-06	1/2	3/8
	T981-08-08	1/2	1/2
	T981-12-12	3/4	3/4
	T981-16-16	1	1

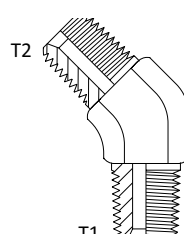
REFERENCIA	PARTE No.	BSPT T1	BSPT T2
T945 Codo 45° Macho BSPT - Macho BSPT 	T945-04-04	1/4	1/4
	T945-06-06	3/8	3/8
	T945-08-08	1/2	1/2
	T945-12-08	3/4	1/2
	T945-12-12	3/4	3/4
	T945-16-16	1	1

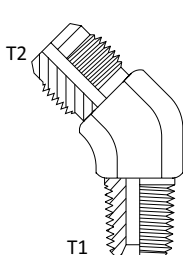
REFERENCIA	PARTE No.	BSPT T1	JIC T2
T909 Codo 45° Macho BSPT - Macho JIC 	T909-02-04	1/8	7/16
	T909-04-04	1/4	7/16
	T909-04-05	1/4	1/2
	T909-04-06	1/4	9/16
	T909-04-08	1/4	3/4
	T909-06-06	3/8	9/16
	T909-06-08	3/8	3/4
	T909-06-10	3/8	7/8
	T909-08-06	1/2	9/16
	T909-08-08	1/2	3/4
	T909-08-10	1/2	7/8
	T909-08-12	1/2	1.1/16
	T909-12-10	3/4	7/8
	T909-12-12	3/4	1.1/16
	T909-12-16	3/4	1.5/16
	T909-16-16	1	1.5/16
	T909-16-20	1	1.5/8
	T909-20-20	1.1/4	1.5/8
T909-24-24	1.1/2	1.7/8	

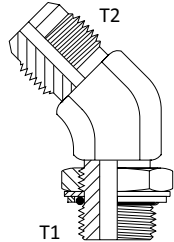
REFERENCIA	PARTE No.	BSPP O-RING T1	JIC T2
T969 Codo 45° Macho BSPP O-RING - Macho JIC 	T969-04-09	1/4	7/16
	T969-08-09	1/2	9/16
	T969-08-12	1/2	3/4
	T969-08-14	1/2	7/8

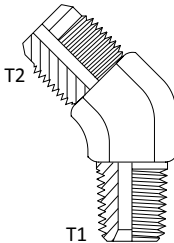
REFERENCIA	PARTE No.	BSPT T1	SAE T2
T990A Codo 45° Macho BSPT - Macho SAE 	T990A-04-10	1/4	5/8
	T990A-06-10	3/8	5/8

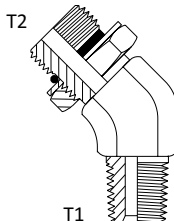
REFERENCIA	PARTE No.	BSPT T1	O-BOSS T2
T960 Codo 45° Macho BSPT - Macho O-RING BOSS 	T960-04-06	1/4	9/16
	T960-06-08	3/8	3/4
	T960-06-10	3/8	7/8
	T960-08-08	1/2	3/4
	T960-08-10	1/2	7/8
	T960-08-12	1/2	7/8
	T960-12-12	3/4	1.1/16
	T960-16-16	1	1.5/16

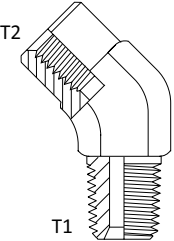
REFERENCIA	PARTE No.	BSPT T1	BSPT T2
T939 Codo 45° Macho BSPT - Hembra BSPT 	T939-04-04	1/4	1/4
	T939-04-06	1/4	3/8
	T939-06-06	3/8	3/8
	T939-08-08	1/2	1/2
	T939-12-12	3/4	3/4

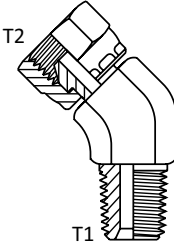
REFERENCIA	PARTE No.	BSPT T1	BSPP T2
T984 Codo 45° Macho BSPT - Hembra BSPP "G" 	T984-04-04	1/4	1/4
	T984-06-06	3/8	3/8
	T984-08-06	1/2	3/8
	T984-08-08	1/2	1/2
	T984-12-12	1	1

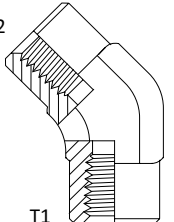
REFERENCIA	PARTE No.	BSPT T1	BSPT T2
T931 Codo 45° Hembra BSPT - Hembra BSPT 	T931-02-02	1/8	1/8
	T931-04-04	1/4	1/4
	T931-06-06	3/8	3/8
	T931-08-08	1/2	1/2
	T931-12-12	3/4	3/4
	T931-16-16	1	1

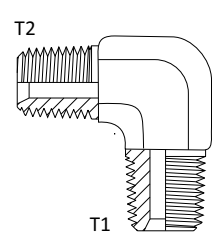
REFERENCIA	PARTE No.	BSPT T1	BSPT T2
T949 Codo 90° Macho BSPT - Macho BSPT 	T949-02-02	1/8	1/8
	T949-04-02	1/4	1/8
	T949-04-04	1/4	1/4
	T949-06-04	3/8	1/4
	T949-06-06	3/8	3/8
	T949-08-04	1/2	1/4
	T949-08-06	1/2	3/8
	T949-08-08	1/2	1/2
	T949-12-08	3/4	1/2
	T949-12-12	3/4	3/4
	T949-16-12	1	3/4
	T949-16-16	1	1
	T949-20-12	1.1/4	3/4
	T949-20-16	1.1/4	1
	T949-20-20	1.1/4	1.1/4
	T949-24-24	1.1/2	1.1/2

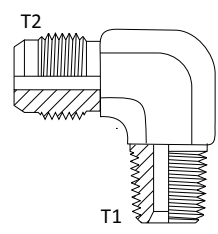
REFERENCIA	PARTE No.	BSPT T1	JIC T2
T908 Codo 90° Macho BSPT - Macho JIC 	T908-02-04	1/8	7/16
	T908-02-05	1/8	1/2
	T908-02-06	1/8	9/16
	T908-04-04	1/4	7/16
	T908-04-05	1/4	1/2
	T908-04-06	1/4	9/16
	T908-04-08	1/4	3/4
	T908-06-04	3/8	7/16
	T908-06-05	3/8	1/2
	T908-06-06	3/8	9/16
	T908-06-08	3/8	3/4
	T908-06-10	3/8	7/8
	T908-08-05	1/2	7/16
	T908-08-06	1/2	9/16
	T908-08-08	1/2	3/4
	T908-08-10	1/2	7/8
	T908-08-12	1/2	1.1/16
	T908-10-10	5/8	7/8
	T908-12-06	3/4	9/16
	T908-12-08	3/4	3/4
	T908-12-10	3/4	7/8
	T908-12-12	3/4	1.1/16
	T908-12-14	3/4	1.3/16
	T908-12-16	3/4	1.5/16
	T908-16-12	1	1.1/16
	T908-16-16	1	1.5/16
	T908-16-20	1	1.5/8
	T908-20-16	1.1/4	1.5/16
T908-20-20	1.1/4	1.5/8	
T908-24-24	1.1/2	1.7/8	

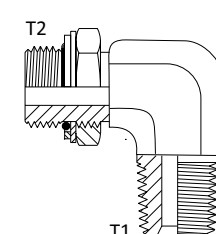
REFERENCIA	PARTE No.	BSPT T1	BSPP O-RING T2
T977 Codo 90° Macho BSPT - Macho BSPP O-RING 	T977-04-04	1/4	1/4
	T977-04-06	1/4	3/8
	T977-06-06	3/8	3/8
	T977-06-08	3/8	1/2
	T977-08-08	1/2	1/2
	T977-08-12	1/2	3/4
	T977-12-12	3/4	3/4
	T977-12-16	3/4	1
	T977-16-16	1	1

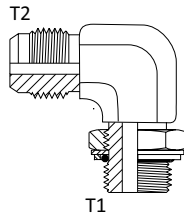
REFERENCIA	PARTE No.	BSPP O-RING T1	JIC T2
T976 Codo 90° Macho BSPP O-RING - Macho JIC 	T976-02-04	1/8	7/16
	T976-04-04	1/4	7/16
	T976-04-05	1/4	1/2
	T976-04-06	1/4	9/16
	T976-04-08	1/4	3/4
	T976-06-04	3/8	7/16
	T976-06-06	3/8	9/16
	T976-06-08	3/8	3/4
	T976-06-10	3/8	7/8
	T976-08-05	1/2	1/2
	T976-08-06	1/2	9/16
	T976-08-08	1/2	3/4
	T976-08-10	1/2	7/8
	T976-08-12	1/2	1.1/16
	T976-12-06	3/4	9/16
	T976-12-08	3/4	3/4
	T976-12-10	3/4	7/8
	T976-12-12	3/4	1.1/16
	T976-12-16	3/4	1.5/16
	T976-16-12	1	1.1/16
T976-16-16	1	1.5/16	
T976-20-21	1.1/4	1.5/16	
T976-20-26	1.1/4	1.5/8	

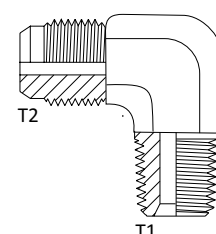
REFERENCIA	PARTE No.	BSPT T1	SAE T2	
T908A Codo 90° Macho BSPT - Macho SAE 	T908A-02-03	1/8	3/8	
	T908A-02-06	1/8	5/8	
	T908A-04-06	1/4	5/8	
	T908A-06-06	3/8	5/8	
	T908A-12-12	3/4	1.1/16	

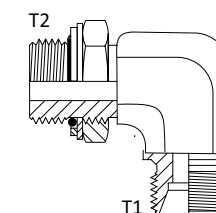
REFERENCIA	PARTE No.	DIN SL T1	BSPP O-RING T2
T977ML Codo 90° Macho DIN S.L. - Macho BSPP O-RING 	T977ML-18-04	18x1,5	1/4
	T977ML-18-06	18x1,5	3/8
	T977ML-18-08	18x1,5	1/2

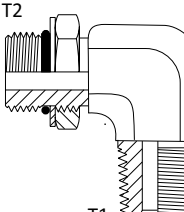
REFERENCIA	PARTE No.	BSPT T1	O-BOSS T2
T989 Codo 90° Macho BSPT - Macho O-BOSS 	T989-04-06	1/4	9/16
	T989-04-08	1/4	3/4
	T989-06-06	3/8	9/16
	T989-06-08	3/8	3/4
	T989-06-10	3/8	7/8
	T989-08-08	1/2	3/4
	T989-08-10	1/2	7/8
	T989-08-12	1/2	1.1/16
	T989-12-08	3/4	3/4
	T989-12-10	3/4	7/8
	T989-12-12	3/4	1.1/16
	T989-16-16	1	1.5/16
	T989-16-20	1	1.5/8
	T989-20-20	1.1/4	1.5/8

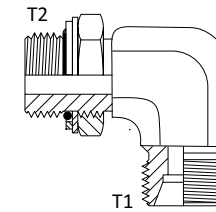
REFERENCIA	PARTE No.	DIN SL T1	BSPP O-RING T2
T977MS Codo 90° Macho DIN S.P. - Macho BSPP O-RING 	T977MS-18-04	18x1,5	1/4
	T977MS-24-08	24x1,5	1/2
	T977MS-30-08	30x2,0	1/2
	T977MS-36-12	36x2,0	3/4
	T977MS-42-12	42x2,0	3/4

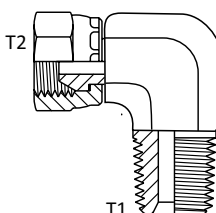
REFERENCIA	PARTE No.	BSPT T1	BSPP T2
T982 Codo 90° Macho BSPT - Hembra BSPP "G" 	T982-02-02	1/8	1/8
	T982-04-04	1/4	1/4
	T982-06-06	3/8	3/8
	T982-08-06	1/2	3/8
	T982-08-08	1/2	1/2
	T982-08-12	1/2	3/4
	T982-12-12	3/4	3/4
	T982-12-16	3/4	1
	T982-16-12	1	3/4
	T982-16-16	1	1

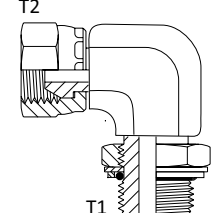
REFERENCIA	PARTE No.	BSPP O-RING T1	BSPP T2
T9105 Codo 90° Macho BSPP O-RING - Hembra BSPP "G" 	T9105-04-04	1/4	1/4
	T9105-06-06	3/8	3/8
	T9105-08-06	1/2	3/8
	T9105-08-08	1/2	1/2
	T9105-08-12	1/2	3/4
	T9105-12-08	3/4	1/2
	T9105-12-12	3/4	3/4
	T9105-12-16	3/4	1
	T9105-16-16	1	1
	T9105-20-20	1.1/4	1.1/4

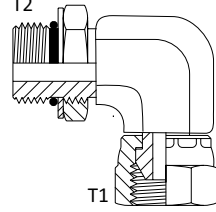
REFERENCIA	PARTE No.	BSPP T1	O-BOSS T2
T994 Codo 90° Hembra BSPP "G" - Macho O-BOSS 	T994-02-04	1/4	7/16
	T994-04-06	1/4	9/16
	T994-06-08	3/8	3/4
	T994-08-08	1/2	3/4
	T994-08-10	1/2	7/8
	T994-12-12	3/4	1.1/16
	T994-16-16	1	1.5/16
	T994-20-20	1.1/4	1.5/8

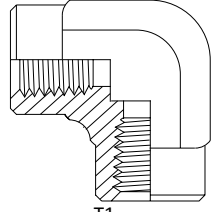
REFERENCIA	PARTE No.	BSPT T1	BSPT T2
T928 Codo 90° Hembra BSPT - Hembra BSPT "F" 	T928-02-02	1/8	1/8
	T928-04-04	1/4	1/4
	T928-06-06	3/8	3/8
	T928-08-08	1/2	1/2
	T928-12-12	3/4	3/4
	T928-16-16	1	1
	T928-20-20	1.1/4	1.1/4

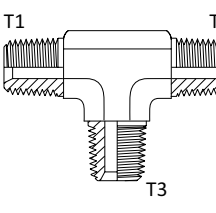
REFERENCIA	PARTE No.	BSPT T1	BSPT T2	BSPT T3
T950 Tee Macho BSPT 	T950-02-02-02	1/8	1/8	1/8
	T950-04-04-04	1/4	1/4	1/4
	T950-06-06-06	3/8	3/8	3/8
	T950-06-06-08	3/8	3/8	1/2
	T950-08-08-08	1/2	1/2	1/2
	T950-08-08-12	1/2	1/2	3/4
	T950-12-08-12	3/4	1/2	3/4
	T950-12-12-08	3/4	3/4	1/2
	T950-12-12-12	3/4	3/4	3/4
	T950-16-12-16	1	3/4	1
	T950-16-16-16	1	1	1
	T950-20-20-20	1.1/4	1.1/4	1.1/4

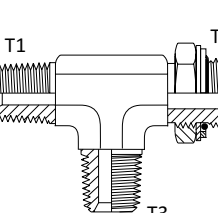
REFERENCIA	PARTE No.	BSPT T1	BSPP O-RING T2	BSPT T3
T9104 Tee Macho BSPT - Macho BSPP O-RING - Macho BSPT 	T9104-04-04-04	1/4	1/4	1/4
	T9104-04-06-04	1/4	3/8	1/4
	T9104-06-06-06	3/8	3/8	3/8
	T9104-08-08-08	1/2	1/2	1/2
	T9104-12-12-12	3/4	3/4	3/4
	T9104-16-16-16	1	1	1
	T9104-20-20-20	1.1/4	1.1/4	1.1/4

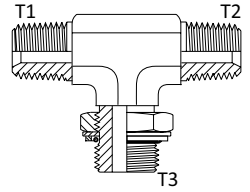
REFERENCIA	PARTE No.	BSPT T1	BSPT T2	BSPP O-RING T3
T9135 Tee Macho BSPT - Macho BSPT - Macho BSPP O-RING 	T9135-06-06-06	3/8	3/8	3/8

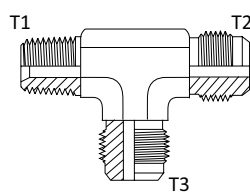
REFERENCIA	PARTE No.	BSPT T1	JIC T2	JIC T3
T921 Tee Macho BSPT - Macho JIC - Macho JIC 	T921-02-04-04	1/8	7/16	7/16
	T921-04-04-04	1/4	7/16	7/16
	T921-04-06-06	1/4	9/16	9/16
	T921-06-06-06	3/8	9/16	9/16
	T921-06-06-08	3/8	9/16	3/4
	T921-06-08-08	3/8	3/4	3/4
	T921-08-08-08	1/2	3/4	3/4
	T921-08-10-10	1/2	7/8	7/8
	T921-08-12-12	1/2	1.1/16	1.1/16
	T921-12-12-12	3/4	1.1/16	1.1/16
T921-16-12-12	1	1.1/16	1.1/16	
T921-16-16-16	1	1.5/16	1.5/16	

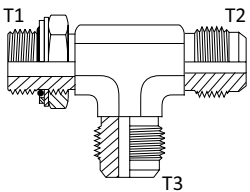
REFERENCIA	PARTE No.	BSPP O-RING T1	JIC T2	JIC T3
T978 Tee Macho BSPP O-RING - Macho JIC - Macho JIC 	T978-04-04-04	1/4	7/16	7/16
	T978-04-06-06	1/4	9/16	9/16
	T978-04-08-08	1/4	3/4	3/4
	T978-06-06-06	3/8	9/16	9/16
	T978-06-08-08	3/8	3/4	3/4
	T978-08-08-08	1/2	3/4	3/4
	T978-08-10-10	1/2	7/8	7/8
	T978-08-12-12	1/2	1.1/16	1.1/16
	T978-12-08-08	3/4	3/4	3/4
	T978-12-12-12	3/4	1.1/16	1.1/16
	T978-16-16-16	1	1.5/16	1.5/16
	T978-20-16-16	1.1/4	1.5/16	1.5/16
	T978-20-20-20	1.1/4	1.5/8	1.5/8

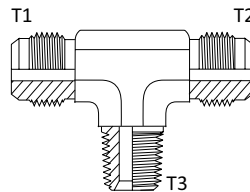
REFERENCIA	PARTE No.	JIC T1	JIC T2	BSPT T3
T920 Tee Macho JIC - Macho JIC - Macho BSPT 	T920-04-04-02	7/16	7/16	1/8
	T920-04-04-04	7/16	7/16	1/4
	T920-05-05-04	1/2	1/2	1/4
	T920-05-05-08	1/2	1/2	1/2
	T920-06-06-04	9/16	9/16	1/4
	T920-08-08-06	3/4	3/4	3/8
	T920-08-08-08	3/4	3/4	1/2
	T920-08-12-08	3/4	1.1/16	1/2
	T920-10-10-06	7/8	7/8	3/8
	T920-10-10-08	7/8	7/8	1/2
	T920-12-12-12	1.1/16	1.1/16	3/4
	T920-12-12-16	1.1/16	1.1/16	1
	T920-16-16-12	1.5/16	1.5/16	3/4
	T920-20-20-20	1.5/8	1.5/8	1.1/4

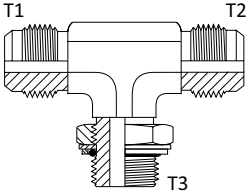
REFERENCIA	PARTE No.	JIC T1	JIC T2	BSPP O-RING T3
T979 Tee Macho JIC - Macho JIC - Macho BSPP O-RING 	T979-04-04-04	7/16	7/16	1/4
	T979-06-06-04	9/16	9/16	1/4
	T979-06-06-06	9/16	9/16	3/8
	T979-08-08-06	3/4	3/4	3/8
	T979-08-08-08	3/4	3/4	1/2
	T979-10-10-08	7/8	7/8	1/2
	T979-10-10-12	7/8	7/8	3/4
	T979-12-12-12	1.1/16	1.1/16	3/4
	T979-16-16-12	1.5/16	1.5/16	3/4
	T979-16-16-16	1.5/16	1.5/16	1
	T979-20-20-20	1.5/8	1.5/8	1.1/4

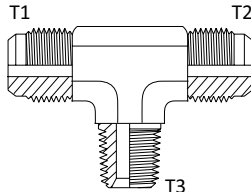
REFERENCIA	PARTE No.	SAE T1	SAE T2	BSPT T3
T920A Tee Macho SAE - Macho SAE - Macho BSPT 	T920A-08-08-06	3/4	3/4	3/8

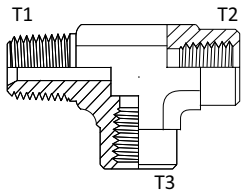
REFERENCIA	PARTE No.	BSPT T1	BSPT F T2	BSPT F T3
T948 Tee Macho BSPT - Hembra BSPT "F" - Hembra BSPT "F" 	T948-02-02-02	1/8	1/8	1/8
	T948-04-04-04	1/4	1/4	1/4
	T948-06-06-06	3/8	3/8	3/8
	T948-08-08-08	1/2	1/2	1/2
	T948-12-12-12	3/4	3/4	3/4
	T948-16-16-16	1	1	1

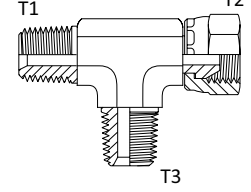
REFERENCIA	PARTE No.	BSPT T1	BSPP T2	BSPT T3
T9167 Tee Macho BSPT - Hembra BSPP "G" - Macho BSPT 	T9167-04-04-04	1/4	1/4	1/4
	T9167-06-06-06	3/8	3/8	3/8
	T9167-08-08-08	1/2	1/2	1/2
	T9167-12-12-12	3/4	3/4	3/4
	T9167-16-16-16	1	1	1

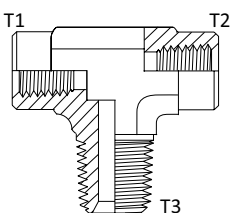
REFERENCIA	PARTE No.	BSPT T1	BSPT T2	BSPT T3
T947 Tee Hembra BSPT "F"- Hembra BSPT "F" - Macho BSPT	T947-08-08-08	1/2	1/2	1/2
	T947-12-12-12	3/4	3/4	3/4
				

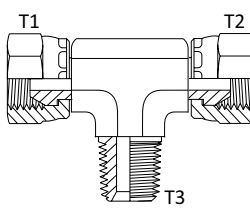
REFERENCIA	PARTE No.	BSPP T1	BSPP T2	BSPT T3
T983 Tee Hembra BSPP "G"- Hembra BSPP "G" - Macho BSPT	T983-04-04-04	1/4	1/4	1/4
	T983-06-06-06	3/8	1/4	3/8
	T983-08-08-08	1/2	1/2	1/2
	T983-12-12-12	3/4	3/4	3/4
	T983-16-16-16	1	1	1
				

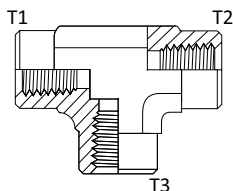
REFERENCIA	PARTE No.	BSPT T1	BSPT T2	BSPT T3
T929 Tee Hembra BSPT "F"- Hembra BSPT "F" - Hembra BSPT "F"	T929-02-02-02	1/8	1/8	1/8
	T929-04-04-04	1/4	1/4	1/4
	T929-06-06-06	3/8	3/8	1/4
	T929-08-08-08	1/2	1/2	1/2
	T929-12-12-12	3/4	3/4	3/4
	T929-16-16-16	1	1	1
	T929-20-20-20	1.1/4	1.1/4	1.1/4
	T929-32-32-32	2	2	2
				

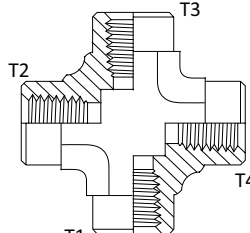
REFERENCIA	PARTE No.	BSPT T1	BSPT T2	BSPT T3
T932 Cruz Hembra BSPT Fija	T932-04-04-04-04	1/4	1/4	1/4
	T932-06-06-06-06	3/8	1/4	3/8
	T932-08-08-08-08	1/2	1/2	1/2
	T932-12-12-12-12	3/4	3/4	3/4
	T932-16-16-16-16	1	1	1
				

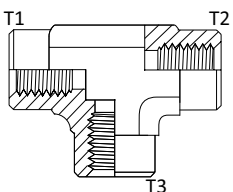
REFERENCIA	PARTE No.	BSPP T1	BSPP T2	BSPP T3
T9139 Tee Hembra BSPP "F"- Hembra BSPP "F" - Hembra BSPP "F"	T9139-32-32-32	2	2	2
				

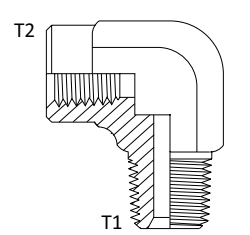
REFERENCIA	PARTE No.	BSPT T1	BSPT T2	
T925 Codo 90° Macho BSPT - Hembra BSPT "F"	T925-02-02	1/8	1/8	
	T925-04-04	1/4	1/4	
	T925-06-04	3/8	1/4	
	T925-06-06	3/8	3/8	
	T925-06-08	3/8	1/2	
	T925-08-06	1/2	3/8	
	T925-08-08	1/2	1/2	
	T925-08-12	1/2	3/4	
	T925-12-12	3/4	3/4	
	T925-16-16	1	1	
T925-20-20	1.1/4	1.1/4		
				

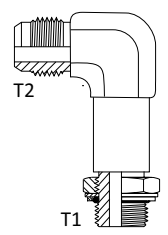
REFERENCIA	PARTE No.	BSPB O-RING T1	JIC T2
T970 Codo 90° Macho BSPP O-RING - Macho JIC Largo 	T970-06-06	3/8	9/16
	T970-06-08	3/8	3/4
	T970-08-08	1/2	3/4
	T970-08-10	1/2	7/8
	T970-12-12	3/4	1.1/16
	T970-16-16	1	1.5/16

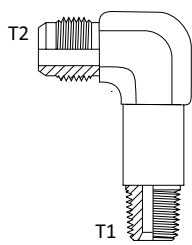
REFERENCIA	PARTE No.	BSPT T1	JIC T2
T911 Codo 90° Macho BSPT - Macho JIC Largo 	T911-02-04	1/8	7/16
	T911-08-10	1/2	7/8