

Industrial spray nozzle



Technology Content	02
A Common Nozzle	10-24
A Series Hollow Cone Spray Nozzle	
—Corner Nozzle Model	
—Mid-High Flow Rate Foundry Nozzle	
—large flow carbide silicone spray nozzle	
—beeline type hollow cone-shaped spray nozzle	
BB Series Full Cone Spray Nozzle	
—standard angle	
—wide angle	
—square standard angle	
—square wide angle nozzle	
—narrow angle nozzles(15°/30°)	
CC Series Flat Fan Nozzle	
—standard angle	
—V Common Narrow Spray Nozzle	
—Wide-angle Spray Nozzle	
B assembled Nozzle	25-26
SJV Three-piece Full Cone Or Flat Fan Spray Nozzle	
—Hollow Cone	
—Solid cone	
—Flat Fan	
—Wide angle	
C Quick Dismantling Nozzle	27-29
QJJ Series Quick Dismantling Nozzle	
—Hollow Cone	
—Full Cone	
—Flat Fan	
—Narrow Nozzle	
QJJ SS Dismantling Nozzle	
D Air Atomizing Nozzle	32-41
D Series Air Atomizing Nozzle	
—Pressure Air Atomizing series	
—Siphon Gravity-Fed Air Atomizing Nozzle Series	
—Flat Pressure Air Atomizing	
DJ Automatic Air Atomizing Nozzle	
DK Automatic Fine Misting Nozzle(colophony nozzle)	
DE Large flow Air Atomizing Nozzle	

E series Spiral Nozzle	42-43
Hollow Cone, Full Cone Spiral Nozzle	
Flanged Silicone Carbide Spray Nozzle	
F Series Fine Misting Nozzle	44-46
AAZ Fine Atomized Nozzle	
FD Anti-drop Misting Nozzle	
FE Plastic Fine Misting Nozzle	
G Series Adjustable Clamp Nozzle.....	47-49
Adjustable Clamp nozzle	
—26988 Adjustabe Global spray Nozzle	
—27988 Adjustabe Global spray Nozzle	
26988RS Adjustabe Global spray Nozzle	
I Series Spray Nozzle	50
PVDF nozzle	
J Plastic Clamp Nozzle	51
J Plastic Clamp Nozzle	
K Series Spray Nozzle For Special Purpose	52-57
K1 Air Absorption Flat Fan Spray Nozzle	
K2 Mixing Fluid Nozzle	
F Wind Jet Nozzle	
K4 Tank Wash Nozzle	
K5 Spray-Dry Nozzle	
L Series Paper and Pulp Nozzle	58-65
High pressure ceramic solid stream nozzle	
Shower high pressure needle nozzle	
Pagoda High Pressure Needle Nozzle	
CCTC Series disc flat fan nozzle	
Low Pressure Flat Fan Spray Nozzle	
EQ Series Self-clean Spay Nozzle	
N Series Nozzle pipe Line Accessories	66-72
155RS Metal Adjustable Spray Nozzle	
Metal Connectors	
Solenoid Valves	
Liquid Filter	
Pressure Gauge	

Advanced Equipments, Assurance of Quality

Our company import the made in Japan CNC machines with the precision exceeding 2μ , and several U.S. precise punching machine with the precision reaching 0.10mm, high pressure test bench and other precise granule test machines. Advanced equipment is the assurance for our quality improvement. The clients can select such materials as polypropylene, ceramics, alloy, imported 303, 304 or 316 stainless steel to make nozzle according to the actual conditions.



Creative Technique and Design

"Life lies in movements, success lies in innovation". Each worker of our Development Department, Production Department and Sales Department are dedicated in improving the performance and quality of spraying products. Basing on satisfying the existing clients, we are constantly forecasting the developing trend of spraying products, constantly innovate and improve our products such as the improvement of existed products, application of new materials and new testing equipments and methods as well as new service. We timely improve our making procedures and techniques according to the market feedback, thus completely integrating with the market and enabling the clients to enjoy the pleasure brought from new technology.

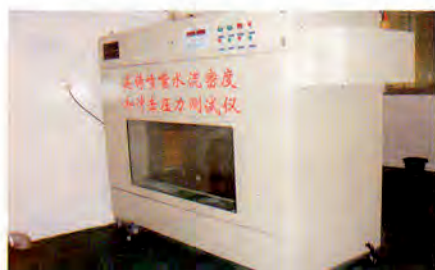

The most previous examination

In the profession, Changyuan Company utilizes of most advanced and most precise testing equipments, we achieve what we have reminded. We are dedicated in improving the testing equipments. We feature strict requirements to the suppliers (metal bars and plastic). Each procedure from nozzle making, packaging, transporting to storing is under strict control. We also present strict policy in finished products checking, thus assuring to provide precise data to our clients.

Pursue global strategy target

Is developing towards the target of world top company with the global strategy vision. All the staffs are devoting to satisfying the requirements of different clients in the world. The powerful R&D team and world wide sales network are capable of satisfying the requirements of the clients in settling the problems in nozzle, presenting project of improvement and even providing the manufacturers of nozzle parts, thus settling the problems of the suppliers terminal clients, and achieving shared resources.



NO international competition,
there's no long term development

Extension of the product application

product features a wide variety of products, including universal cleaning nozzle, high pressure atomization nozzle, high pressure cleaning nozzle, from the ordinary workpiece cleaning to environment protection dust removing and desulfurizing to the corrosive carving and cleaning of electronic circuit board, from phosphorization to humidifying, lubricating, iron and steel dephosphorization.



Plastic parts automatic coating treatment



For cleaning and dust removing



For corrosive carving and cleaning circuit board



For cleaning electroplated wires



For auto parts surface treatment



For automobile coating



For distinguishing of drilling platform

Spraying Pattern

The spraying pattern of the nozzle consist of four types:

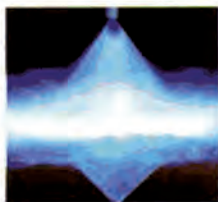

1. Fan Fan

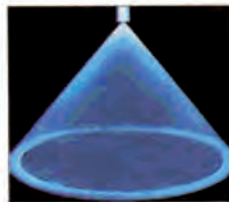

2. Hollow Cone

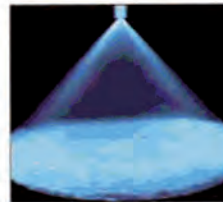

3. Full Cone

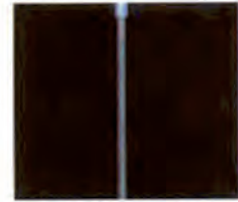

4. Solid stream

The difference of Spraying Granule

Our company separate showering and spraying, it is called as spraying if the granule is less than 100mm, and showering more than 100mm. usually, The nozzle for spraying is used for workshop humidifying, artificial fog and spraying drying. However, nozzle for showering is mainly used for removing dust, cleaning and dephosphorizing for iron and steel.

Tolerance of Nozzle Flux and Angle

The tolerance of capacity of our nozzle is $\pm 5.5\%$

The tolerance of angle of our nozzle is $\pm 5^\circ$

The tolerance of angle of solid stream is $\pm 3^\circ$

Material Selection of the Nozzle

In various kinds of nozzles, has marked the materials on the products, the ordinary engineering PP nozzles are marked with PP, stainless steel SS, brass BRASS, for see the table below for details:

Plastic	Poly(vinyl chloride)	PVC
	Poly propylene	PP
	Polyphenylene oxide	PP0
	Acrylonitrile butadiene styrene	ABS
	Polyvinylidene Fluoride	PVDF
	Polyphenylene styrene	PPS
	Poly Tetra Fluoro Ethylene	PTFE
	Epoxy Resin	ARALDITE
	Fibre Reinforced Plastic	FRP

Metal	BRASS	BRASS
	303 Stainless Steel	303SS
	304 Stainless Steel	304SS
	316 Stainless Steel	316SS
	316L Stainless Steel	316LSS
	Titanium	TN
	Hard Alloy	CCA
	Aluminum Alloy	ALMA
	Special Material	Sapphire
Carbuncle		RUS
Graphite		GRS
Ceramics		SIS

A range of application

The application scope is widespread, penetrates into various areas, the product has covered with surface treatment, electron, spinning and weaving, steel and iron, drugs manufacture. Increasing application scope evince that CYCO'S nozzle has been a dramatic influence

■Washing

Semiconductor wafer cleaning
 Waste gas desulphurization
 Cement mixer's high-pressured cleaning
 Brewage barrel's self-cleaning
 Processing chemical cleanings for automobile, - motorcycle, domestic electric appliances and so on
 High pressure washing
 Electronic circuit board cleaning
 circuit chemical washing
 Beer bottle cleaning
 mirror industry glass cleaning
 Clean the sand on the strainer
 Sand , coal , gravel washing
 The paper mill wool blanket and nettings clean
 Tank ans inside surface of tank clean
 biscuit packaging environment for food-processing
 Strainer and filter
 Fruit & vegetables washing
 bottle capsule clean for food-processing
 mirror industry glass cleaning
 Clean industrial equipment
 Clean the article suspension chain
 Metal cleaning and processing
 Container washing
 High pressure water for dephosphorization on- the surface of rolled steel
 barrels self-cleaning
 plastic containers cleaning
 Various of Containers and OilTank cleaning
 Clean the floor in processing workshop

■Humidify for space and local resistance

Adjust air humidity printery
 Prevent the plastic part Electrostatic
 thermal insulation in storeroom for bloat fresh fruit
 Humidify for printery
 silica gel and coating in press cylinder
 oxygen chamber in hospital
 twig cutting flowers freezing chamber
 spray drying LCF-A facility adjust the temperature
 pavilion
 qpray pond

■AntiVirus and disinfection

Bottle capsule's disinfection
 Rice vessel's backwoods coli countermeasure

■Cooling

Candle factory's gas ignition
 Steel continuous casting
 skin coverage wire elongation project
 plastic pipe forming
 Cooling tower
 conveyer belt colling
 heat treatment before quenching
 Die casting cooling
 PVC pipe extrude cooling
 The secondary cooling of billet continuous casting machine
 In Steel rolls cooling
 storage tanks cooling
 Roof cooling
 spiral condenser cooling
 chamber at kiln back end cooling
 aluminium ware angioclast cooling
 hoop rolling mill cooling
 tool and material colling
 Before electrostatic precipitation cooling and humidifying
 draper-type muller cooling
 drinks cooling
 Wire stretch project cooling
 Plastic moldings cooling
 Product direct and indirect cooling
 Spray and temperature drop for equipment

■Spice additive industry

Products concoction
 Hot water and gas involve in the steam

Prevents the coated paper cambered surface to split
 mushroom cultivates
 Humidify for textile workshop
 Humidify for cellophone
 Cold holdingroom
 Humid room
 System for paper humidify
 Humidify for corrugated paper system
 Man-power snows machine
 mist producer for garden



steel rolls cooling



Humidify for space prevent electrostatic



Humidify for mushroom cultivates



storage groove LNG

■Spraying & Coating

sirup spray on sponge cake
dustproof spray on iconoscope
sugar-coating
spray adhesives on construct plywoods
phosphorize metal parts
airless spray and spray paint
tablet coating
antirust spray
papermaking material roll spray
spray dye on products to identify
cere, colophony and wet menstruum spray on medicament
baste before firing food
additive and condiment spray on food
safeguard coating on furniture
spray remover on mould
brick and color tile glazing
metal surface basting
wall spray of instrument and beverage tin
deodorization in chimney
glue coating on printing roller
egg-juice coating on cake and biscuit
separant coating on metal
glazing and painting on tile
liquor spray on brick

■Removing & Peel off

papermaking, clean paper edge
volume label peel off bottles
separate option of quality control
dust removing off glass board
paper machine finishing
metal sheet discerption before punch
replacing indication of air condition filter

■Dust prevention

grist deposite field conveying
prevent dust from clinging after coating
cement and mill factory
prevent dust when conveying foundation
garbage clearing vehicle push down ash to ground
wipe off dust from cupola
coal ash control when dumping coal
cement factory
dust let from chimney and incinerator

■Surface treatment

spray anti-rust oil on metal pipe
ceramic tile glazing
dye marker of making corrugating mould
separant coating on mould
protection spraying on glass board
cere spraying in glass bottle

■Agriculture & stockbreeding

farming irrigation
spray pesticide
fight a drought irrigation
vegetation protection
grow fungus
spray root of crops
large-scale spraying of crops

■Dust control

dust control when conveying coal ash and sand
humidify the top of tram
wipe off dust from gas lower
ferric oxide control in steel rolling
coal ash control when dumping coal
dust control at cement factory
dust control when conveying wooden bits
garbage clearing vehicle push down ash to ground
dust control in conveying, loading and unloading garbage
wipe off dust from cupola

■Lubricate

lubricating and rust prevention on iron board
lube coating on bottle
lube coating in punch project
lube coating on cable
lubricate gear
spray remover
lubricate conveyer belt and drive chain
lubricate wire rope
molding lubricate on large-scale forge press
hydraulic pressure machine oiling
lubricate reamer slice and spring
lubricate axis and axletree

■Fire protection

electric appliance fitting section
pressure vessel
coal store section
horizontal multilayer drier
rocket and missile test bed
house and common building
mine
convey belt channel
nuclear power station fire protection
oil trough and gas trough fire protection
oil station of tank car
rocket launcher fireproofing insufflation
deposited jar
pipeline of steel mill and epurating mill
Liquefied petroleum gas trough and tank car
shipping and pigboat
offing oil field
transformer substation and farming machine substation
bin char prevention

■salt damage examination

salt damage test
salt damage examination
reaction test

■Gas control

air scrubbing in spray-paint booth
air scrubbing in pipe and cleaning tower
remove sulfur dioxide (SO_2)
nitrogen oxides control (NOX)
deodorization of chimney
reactor cleanout system
air cleaning system of air control system
ferric oxide ash control in steel rolling
centrifugal damp dust picker
remove dust from chimney and incinerator
spray ammonia to eliminate static
spray lime slurry to remove sulfur dioxide



Tower desulfurization
in power station



Pretreatment for
car industry



Textile workshop
humidification



Coding in HongKong
Ocean Park



Coding in HongKong
Ocean Park

►► The principle of work of laser particle sizer

- 1、 The laser will scatter around the granule, it is a method to connect the refraction image with the interference of the light. The diameter tested is a bit smaller than the actual granule.
- 2、 It forms two interference light stripes with crossing laser light, sense the scatters of the granule of the interference light with several light sensors in certain distance, thus calculating the diameter of the granule with the potential difference. This method is free of the influence of granule density and can test the speed of the granule simultaneously.

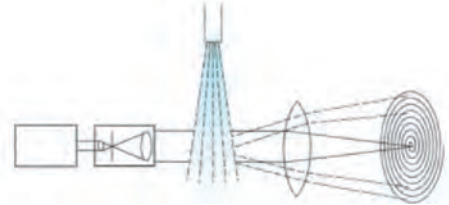

The material of the nozzle has different effect to the wearable resistance of the liquid

The liquid flows at high speed at the mouth of the nozzle, therefore, the nozzle mouth will be easily worn. Different chemical liquid has different PH value and viscosity, and has different friction to the nozzle. The friction to the nozzle is also different even the PH value and viscosity is the same if different materials are used. The hardness of ceramics (SIS) is 7, and the wearable resistance is 20-30 times of stainless steel, but ceramics is fragile and hard for making, alloy has high wearable resistance but also has high cost in making, stainless steel nozzle has a extremely wide application for it features high wearable resistance, though the price is higher than plastic but much lower than alloy and ceramic, therefore it is widely promoted. Engineering plastic nozzle has poor wearable resistance, but it features low cost with perfect performance in chemical resistance, therefore it is the nozzle with most application.

The spraying angle of the nozzle is different under different pressure

Under different pressure, the spraying angle will change. Under low pressure, the angle is small and the cleaning strength is also small, when the pressure is gradually increasing, the spraying angle is also increasing, so does the cleaning strength. Different materials have different performance in enduring pressure, therefore, it is common that the nozzle is required to be used under standard pressure. If the nozzle is wearable, the Flux of it will change and the spraying angle will also change, the flux increases, the pressure drops and the spraying angle will also be small, the wearable spraying mouth will change the spraying direction, thus largely dropping the using efficiency.

Impact Force

The injection force differs in different injection shape under same pressure. The solid stream features highest impact, and then the fat fan, hollow cone and full cone.

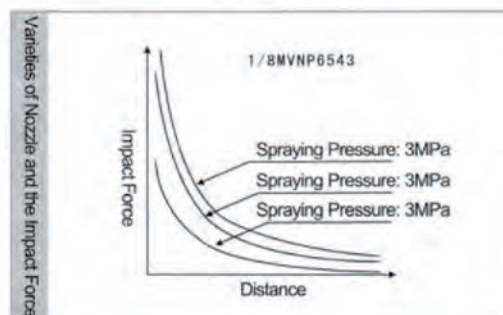
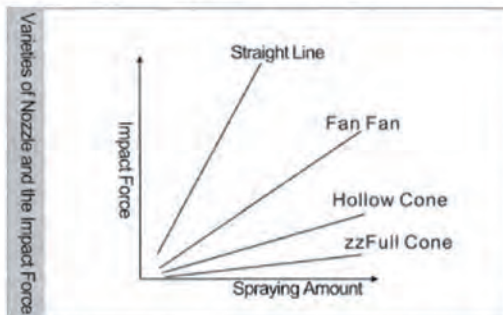

It is important to maintain the nozzle

Under different PH value, viscosity and pressure, nozzles made of different materials have different wearable resistance. Therefore, the clients should periodically clean and maintain even replace the nozzle according to the actual condition. The nozzle will be easily clogged when cleaning dirty work pieces. So you have to change the cleanness of the solution, filter the liquid, and periodically clean the nozzle for achieving normal injection effect. If the PH value of the solution is extremely strong, it is required to select nozzle made of anti-corrosion materials (316F and PVDF), if the density of the solution is extremely high, it is required to select nozzle with high wearable resistance (Ceramics, alloy), if the nozzle is jammed, the workpiece can't be completely cleaned and the pump will run overloading, thus largely damaging the entire equipments, therefore, it is very important to maintain the nozzle.



Conversion Unit

Has provided the following conversion unit for the client's correct calculation when selecting the products.

Area			
cm ²	m ²	in ²	ft ²
1	1 × 10 ⁻⁴	0.155	1.08 × 10 ⁻⁶
1 × 10 ⁴	1	1.55 × 10 ³	10.8
6.45	6.45 × 10 ⁻⁴	1	6.94 × 10 ⁻³
9.30 × 10 ²	9.30 × 10 ⁻²	1.44 × 10 ²	1

Length					
um	mm	cm	m	in	ft
1	1 × 10 ⁻³	1 × 10 ⁻⁴	1 × 10 ⁻⁶	3.94 × 10 ⁻⁵	3.28 × 10 ⁻⁶
1,000	1	0.1	1 × 10 ⁻³	3.94 × 10 ⁻²	3.28 × 10 ⁻³
1 × 10 ⁴	10	1	1 × 10 ⁻²	3.94 × 10 ⁻¹	3.28 × 10 ⁻²
1 × 10 ⁷	1 × 10 ³	100	1	3.94 × 10	3.28
2.54 × 10 ⁴	25.4	2.54	2.54 × 10 ⁻²	1	8.33 × 10 ⁻²
3.05 × 10 ⁵	3.05 × 10 ²	3.05 × 10	3.05 × 10 ⁻¹	12	1

Flow rate						
/Min	m ³ /min	m ³ /hr	in ³ /hr	ft ³ /h	GAL: Metric GAL	GAL: British GAL
1	0.001	0.06	3.66 × 10 ³	2.12	0.264	0.22
1,000	1	60	3.66 × 10 ⁶	2.12 × 10 ³	264	220
16.67	0.017	1	6.10 × 10 ⁴	35.3	4.40	3.67
2.73 × 10 ⁻⁴	2.7 × 10 ⁻⁷	1.64 × 10 ⁻⁵	1	5.79 × 10 ⁻⁴	7.22 × 10 ⁻⁵	60.1 × 10 ⁻⁵
0.472	4.72 × 10 ⁴	0.028	1.728	1	0.125	0.104
3.79	0.004	0.227	1.39 × 10 ⁴	8.02	1	0.833
4.55	0.005	0.273	1.66 × 10 ⁴	9.63	1.2	1

Pressure						
KPa	bar	kg/cm ²	ib/in ² (psi)	Atm	mHg	mH ₂ O(mAg)
1	0.01	0.01	0.145	9.87 × 10 ⁻³	7.50 × 10 ⁻³	0.102
100	1	1.020	14.5	0.987	0.750	10.2
98.07	0.981	1	14.22	0.968	0.736	10.01
6.89	0.069	0.070	1	0.068	0.052	0.704
1.01 × 10 ²	1.013	1.033	14.7	1	0.76	10.34
1.33 × 10 ²	1.33	1.36	19.3	1.32	1	13.61
9.807	0.098	0.10	1.42	0.097	0.073	1

Dimension						Others	
cm ³	l	M ³ (kl)	ft ³	GAL: British GAL	GAL: Metric GAL	Viscosity	Weight
1	1 × 10 ⁻³	1 × 10 ⁻⁶	3.53 × 10 ⁻⁵	2.2 × 10 ⁻⁴	2.64 × 10 ⁻⁴		
1,000	1	1 × 10 ⁻³	3.53 × 10 ⁻²	0.22	0.264	1St=100cSt	
1 × 10 ⁶	1,000	1	353	220	264	Temperature [°F] = [(°C) × 5/9] + 32 [°C] = 5/9 [(°F) - 32]	
2.83 × 10 ⁴	28.3	2.83 × 10 ⁻²	1	0.623	0.749		
4.55 × 10 ³	4.55	4.55 × 10 ⁻³	1.6	1	1.2		
3.79 × 10 ³	3.79	3.79 × 10 ⁻³	1.34	0.833	1		

Water Flow and Suitable Pipe Diameter					Water Flow and Suitable Pipe Diameter				
Pipes Diameter		Steel Tube		Flow rates when the pipe is 10m and the pressure loss ranges 0.01-0.03MPa	Pipes Diameter		Steel Tube		Flow rates when the pipe is 10m and the pressure loss ranges 0.01-0.03MPa
A	B	Internal	External		A	B	Internal	External	
6A	1/8B	6.5	10.5	1.3-2.2	40A	11/2B	41.6	48.6	120-210
8A	1/4B	9.2	13.8	3-5.2	50A	2B	52.9	60.5	215-370
10A	3/8B	12.7	17.3	7-12	65A	21/2B	67.9	76.3	410-700
15A	1/2B	16.1	21.7	12-21	80A	3B	80.7	89.1	680-1,200
20A	6B	21.6	27.2	22-38	100A	4B	105.3	114.3	1,200-2,100
25A	1B	27.6	34.0	38-65	125A	5B	130.8	139.8	2,100-3,600
32A	11/4B	35.7	42.7	70-120	150A	6B	155.2	165.2	3,300-5,700

SPRAY ANGLE AND COVERAGE

Tabulated spray angles indicate approximate coverages based on spray of or distribution of water .In actual spraying ,the effective spray angle varies with spray distance. Liquids more than water form relatively smaller spray angles (or even a solid stream),depending upon viscosity , nozzle capacity and spraying pressure . Liquids with surface tensions lower than those listed for water .This table lists the theoretical coverage of spray patterns as calculated from the included spray angle of the spray and the distance . In actual practice,the tabulated spray angle does not hold for long spray distances ,if the spray coverage requirement is critical ,request data sheets for specific spray coverage data .

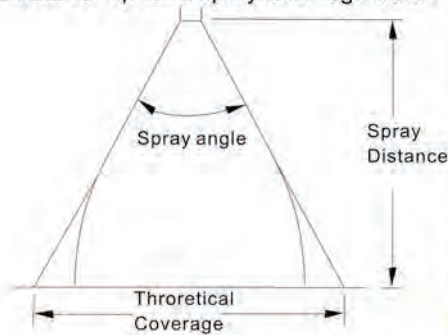

spray angle	The coverage under different distance(mm)											
	5cm	10cm	15cm	20cm	25cm	30cm	40cm	50cm	60cm	70cm	80cm	100cm
5°	0.4	0.9	1.3	1.8	2.2	2.6	3.5	4.4	5.2	6.1	7.0	8.7
10°	0.9	1.8	2.6	3.5	4.4	5.3	7.0	8.8	10.5	12.3	14.0	17.5
15°	1.3	2.6	4.0	5.3	6.6	7.9	10.5	13.2	15.8	18.4	21.1	26.3
20°	1.8	3.5	5.3	7.1	8.8	10.6	14.1	17.6	21.2	24.7	28.2	35.3
25°	2.2	4.4	6.7	8.9	11.1	13.3	17.7	22.2	26.6	31.0	35.5	44.3
30°	2.7	5.4	8.0	10.7	13.4	16.1	21.4	26.8	32.2	37.5	42.9	53.6
35°	3.2	6.3	9.5	12.6	15.8	18.9	25.2	31.5	37.8	44.1	50.5	63.1
40°	3.6	7.3	10.9	14.6	18.2	21.8	29.1	36.4	43.7	51.0	58.2	72.8
45°	4.1	8.3	12.4	16.6	20.7	24.9	33.1	41.4	49.7	58.0	66.3	82.8
50°	4.7	9.3	14.0	18.7	23.3	28.0	37.3	46.6	56.0	65.3	74.6	93.3
55°	5.2	10.4	15.6	20.8	26.0	31.2	41.7	52.1	62.5	72.9	83.3	104
60°	5.8	11.6	17.3	23.1	28.9	34.6	46.2	57.7	69.3	80.8	92.4	115
65°	6.4	12.7	19.1	25.5	31.9	38.2	51.0	63.7	76.5	89.2	102	127
70°	7.0	14.0	21.0	28.0	35.0	42.0	56.0	70.0	84.0	98.0	112	140
75°	7.7	15.4	23.0	30.7	38.4	46.0	61.4	76.7	92.1	107	123	153
80°	8.4	16.8	25.2	33.6	42.0	50.4	67.1	83.9	101	118	134	168
85°	9.2	18.3	27.5	36.7	45.8	55.0	73.3	91.6	110	128	147	183
90°	10.0	20.0	30.0	40.0	50.0	60.0	80.0	100	120	140	160	200
95°	10.9	21.8	32.7	43.7	54.6	65.5	87.3	109	131	153	175	218
100°	11.9	23.8	35.8	47.7	59.6	71.5	95.3	119	143	167	191	238
110°	14.3	28.6	42.9	57.1	71.4	85.7	114	143	171	200	229	286
120°	17.3	34.6	52.0	69.3	86.6	104	139	173	208	243		
130°	21.5	42.9	64.3	85.8	107	129	172	215	257			
140°	27.5	55.0	82.4	110	137	165	220	275				
150°	37.3	74.6	112	149	187	224	299					
160°	56.7	113	170	227	284							
170°	114	229										

The folow rate with the pressure

The spray performance are based on the same medium is corresponding to the square root of the pressure . Any nozzle can count the liquid at the ppressure .

$$\frac{Q_1 \text{Flow rate(L/min)}}{Q_x \text{Flow rate(L/min)}} = \frac{\sqrt{F_1 \text{Pressure (kg)}}}{\sqrt{F_2 \text{Pressure (kg)}}$$

so it comes to

$$Q_x = Q_1 \sqrt{\frac{F_2 \text{Pressure (kg)}}{F_1 \text{Pressure (kg)}}$$

Usage of Atomization Nozzle

一、 Usage of Flat Fan Nozzle

The liquid of the flat fan nozzle is sprayed in fan with higher impact force than hollow cone and full cone, in order to achieve even flux when installing several fan-shaped nozzles, they are installed in mountain-shaped.

The flux distribution, spraying height, distance of the installation positions, spraying pressure and the liquid nature are different, if the performances of several nozzles are different, then the designed value and the actual value will also vary. assures that the nozzles feature adequately precise for achieving uniform distribution.

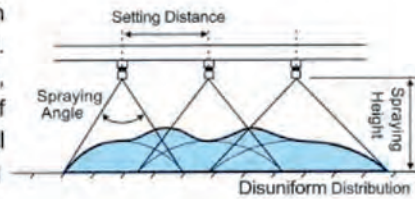

(1) If the performance is different

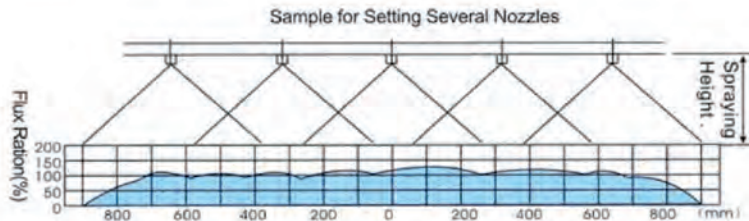

(2) Sample for setting several nozzles with precision assurance

二、 Usage of Hollow Cone Nozzle

Under the condition that the spraying pressure, flux and angle are the same, the average granule of hollow cone nozzle is smallest. With average granule, the surface area of the workpiece exceeds and the surface is treated more fine, thus achieving smooth movement to the objects. The hollow cone nozzle has fine effect when it is used for gas cooling, air humidifying, metal treatment, dust control, gas cleaning and chemical reaction etc. In hollow cone nozzle, liquid is sprayed from the single hole under centrifugal effect, therefore, it has highest smooth diameter and is an ideal selection for the liquid which may easily deposit, for it can reduce clogging to the max.

* The clients may select suitable usage according to distribution.
Installation Distribution of Hollow Cone Nozzle

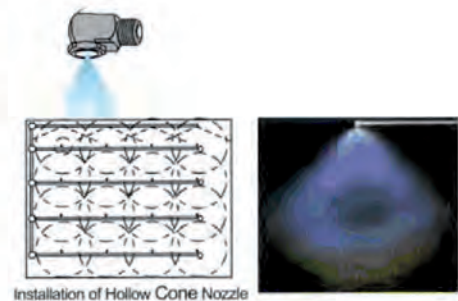

三、 Usage of Full Cone Nozzle

Full Cone Nozzle consists of two varieties, the common type is equipped with built-in rotational flow leaves, but the special type not, It produce small to medium-sized drops. The spraying area is round. Therefore, it is suitable for cleaning, bleaching, dust removing, distinguishing, corrosive carving and cleaning of electronic circuit board etc

* The clients may select suitable usage according to distribution.
Installation Distribution of Hollow Cone Nozzle

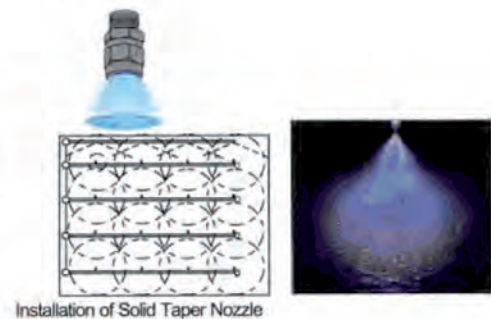

四、 Selection of Strainer

Nozzle will have use different strainer according to the using condition, rough strainer for the nozzle with big granule, and fine strainer for small granule. The specification of the strainer is confirmed according to the quantity, please refer to the table below:

The built-in strainer in the nozzle composes of strainer body, cap and strainer mesh.

Strainer mesh	Distance of Mesh	Granule (mm)
#200	0.07	Less than 0.2
#150	0.10	0.3-0.4
#100	0.15	0.5-0.7
#50	0.30	0.8-0.9

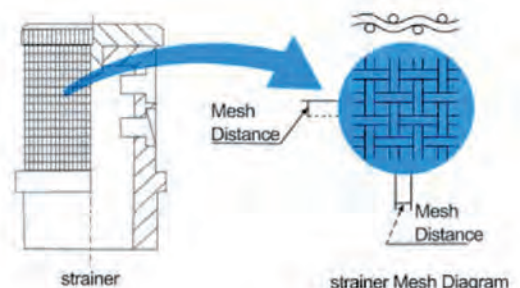

Design features of large flow carbide silicone spray nozzle

Large carbide silicone spray nozzle, with its spray pattern is hollow cone-shaped, can spray an annular area. It has two series of different spray angles, its standard angle is between 70°-90°. The whole spray nozzle is made of carborundum together with carborundum material. It can be applied under bad working condition, and can also produce uniform spray distribution of medium and larger sized drops under high pressure in a large-scale area. The large flux carborundum spray nozzle can be made into 4 different sizes: 2 inch, 3 inch, 4 inch and 6 inch. It can avoid clogging on the whole with its large and easy flow passages.



As a whole made of carborundum

Performance data

flange inlet	Capacity Size	Inlet Dia. Nom. Size (mm)	Rated Orifice Dia. (mm)	Capacity (L/min)										Spray angle		
				0.2 bar	0.5 bar	1 bar	1.5 bar	2 bar	3 bar	4 bar	5 bar	6 bar	7 bar	0.5 bar	1.5 bar	4 bar
2	30-40°	36.5	23.8	73	116	163	200	230	285	325	365	400	430	70°	85°	90°
	35-45°		27.0	85	135	191	235	270	330	380	425	465	500	70°	85°	90°
	40-45°		30.2	97	154	220	265	310	375	435	490	530	580	70°	85°	90°
	45-45°		32.1	110	173	245	300	345	425	490	550	600	650	70°	85°	90°
	50-45°		34.9	122	193	270	335	385	470	540	610	670	720	70°	85°	90°
	55-45°		36.9	134	210	300	365	425	520	600	670	730	790	70°	85°	90°
3	70	57.2	34.9	171	270	380	465	540	660	760	850	930	1010	70°	85°	90°
	85		40.1	205	325	465	570	650	800	930	1040	1130	1230	70°	85°	90°
	100		44.5	245	385	540	670	770	940	1090	1220	1330	1440	70°	85°	90°
	120		52.4	290	460	650	800	920	1130	1310	1460	1600	1730	70°	85°	90°
	140		58.7	340	540	760	930	1080	1320	1530	1710	1870	2020	70°	85°	90°
	55-45°		34.9	171	270	380	465	540	660	760	850	930	1010	70°	85°	90°
	85-45°		40.1	205	325	465	570	650	800	930	1040	1130	1230	70°	85°	90°
	100-45°		44.5	245	385	540	670	770	940	1090	1220	1330	1440	70°	85°	90°
	120-45°		51.2	290	460	650	800	920	1130	1310	1460	1600	1730	70°	85°	90°
	140-45°		58.7	340	540	760	930	1080	1320	1530	1710	1870	2020	70°	85°	90°
4	150	79.4	50.8	365	580	820	1000	1160	1420	1630	1830	2000	2160	70°	85°	90°
	175		59.1	425	670	950	1170	1350	1650	1910	2130	2340	2520	70°	85°	90°
	200		68.3	485	770	1090	1330	1540	1890	2180	2440	2670	2880	70°	85°	90°
	225		74.6	550	870	1230	1500	1730	2120	2450	2740	3000	3240	70°	85°	90°
	250		82.6	610	960	1360	1670	1930	2360	2720	3050	3340	3600	70°	85°	90°
	275		92.1	670	1060	1500	1840	2120	2600	3000	3350	3670	3960	70°	85°	90°
	150-45°		50.8	365	580	820	1000	1160	1420	1630	1830	2000	2160	70°	85°	90°
	175-45°		59.1	425	670	950	1170	1350	1650	1910	2130	2340	2520	70°	85°	90°
	200-45°		68.3	485	770	1090	1330	1540	1890	2180	2440	2670	2880	70°	85°	90°
	225-45°		74.6	550	870	1230	1500	1730	2120	2450	2740	3000	3240	70°	85°	90°
	250-45°		82.6	610	960	1360	1670	1930	2360	2720	3050	3340	3600	70°	85°	90°
	6		250	124	62.3	610	960	1360	1670	1930	2360	2720	3050	3340	3600	70°
300		69.9	730		1160	1630	2000	2310	2830	3270	3650	4000	4320	70°	85°	90°
350		76.2	850		1350	1910	2340	2700	3300	3810	4260	4670	5050	70°	85°	90°
400		82.6	970		1540	2180	2670	3080	3770	4360	4870	5340	5770	70°	85°	90°
450		88.1	1100		1730	2450	3000	3470	4250	4900	5480	6010	6490	70°	85°	90°
500		97.2	1220		1930	2720	3340	3850	4720	5450	6090	6670	7210	70°	85°	90°
550		108	1340		2120	3000	3670	4240	5190	5990	6700	7340	7930	70°	85°	90°
620		130	1520		2410	3410	4170	4820	5900	6810	7610	8340	9010	70°	85°	90°
440-65°		88.1	1070		1700	2400	2940	3390	4150	4790	5360	5870	6340	70°	85°	90°
550-65°		108	1340		2120	3000	3670	4240	5190	5990	6700	7340	7930	70°	85°	90°
625-65°		130	1520		2410	3410	4170	4820	5900	6810	7610	8340	9010	70°	85°	90°

N-sic material performance data

Temperature	Heat transfer parameter	multi-gap rate	heat expansion parameter	flexural strength	Mohs's scale of hardness	Acid corrosion
<1400°C	45w/m.k	<0.1%	4.5k ⁻¹ X10 ⁻⁶	600mPa	>13	Excellent

Design features of AASW large flow carbide silicone spray nozzle

- 1.Spray consistency is uniform.
- 2.Spray liquid droplets distribute at a large range
- 3.The spray liquid droplet size is 20%-80% smaller than other hollow cone-shaped nozzles'.

The graph given below is the compare data between AASW spray nozzle and common hollow cone-shaped nozzles at the same flow rate. It's easy to find that the spray liquid droplets of AASW spray nozzle distribute at a larger range, so that it can minimize the spray consistency consumedly; Meanwhile, its droplet size is 50% smaller than common hollow cone-shaped nozzles.

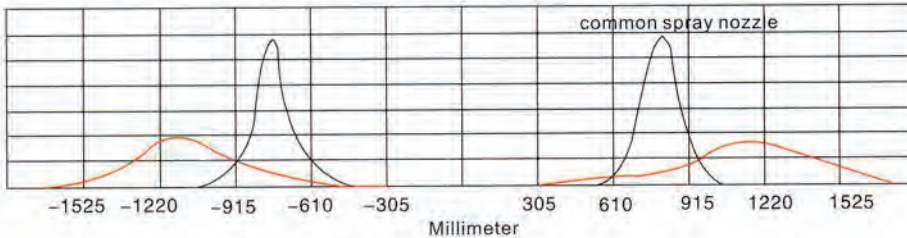

flow rate and size of AASW

hollow cone-shaped, wide angle, 1" to 3" size BSP or NPT screw thread.

flange inlet	Nozzle Type	Spray angle			K coef-ficient	Capacity(L/min)								inlet size	Cap-acity size	Size				Weight
		0.3 bar	1 bar	3 bar		0.2 bar	0.3 bar	0.5 bar	0.7 bar	1 bar	1.5 bar	2 bar	3 bar			A	B	C	D	
2	SW 8516	112°	115°	115°	194	86.6	106	137	162	194	237	274	336	21.8	21.8	91.9	130	114	70.6	1.81
	SW 10516	120°	122°	122°	239	107	131	169	200	239	293	338	414	25.4	25.4					
	SW 12516	119°	122°	122°	285	127	156	201	328	285	349	403	493	29.0	29.0					
	SW 14516	122°	125°	125°	330	148	181	234	276	330	405	467	572	32.1	32.1					
	SW 17016	125°	125°	125°	387	173	212	274	324	387	474	548	671	35.3	35.3					
	SW 19216	125°	125°	125°	438	196	240	309	366	438	536	619	758	38.5	36.5					
	SW 20516	125°	125°	125°	467	209	256	330	391	467	572	661	809	41.3	36.5					
2 1/2	SW 23016	125°	125°	125°	524	234	287	371	439	524	642	741	908	44.5	36.5	125	172	143	88.1	2.90
	SW 17020	117°	120°	120°	387	173	212	274	324	387	474	548	671	33.7	33.7					
	SW 19020	117°	120°	120°	433	194	237	306	362	433	530	612	750	36.1	36.1					
	SW 20520	117°	120°	120°	467	209	256	330	391	467	572	661	809	37.3	37.3					
	SW 23020	123°	125°	125°	524	234	287	371	439	524	642	741	908	40.1	40.1					
	SW 28020	128°	130°	130°	638	285	349	451	534	638	781	902	1110	46.0	44.5					
	SW 32020	128°	130°	130°	729	326	399	516	610	729	893	1030	1260	51.2	44.5					
3	SW 34020	128°	130°	130°	775	347	424	548	648	775	949	1100	1340	53.2	44.5	145	200	173	109	4.08
	SW 43520	128°	130°	130°	991	443	543	701	829	991	1210	1400	1720	61.9	44.5					
	SW 18524	122°	122°	122°	422	189	231	298	353	422	516	596	730	32.5	32.5					
	SW 23024	122°	122°	122°	524	234	287	371	439	524	642	741	908	36.5	36.5					
	SW 28024	122°	122°	122°	638	285	349	451	534	638	781	902	1110	41.3	41.3					
	SW 32024	125°	125°	125°	729	326	399	516	610	729	893	1030	1260	45.2	45.2					
	SW 34024	125°	125°	125°	775	347	424	548	648	775	949	1100	1340	46.8	46.8					
	SW 12224	128°	130°	130°	939	420	514	664	786	939	1150	1330	1630	53.6	53.6					
	SW 46924	129°	132°	135°	1070	478	585	756	894	1070	1310	1510	1850	57.9	54.0					
	SW 52624	129°	132°	135°	1200	536	657	848	1000	1200	1470	1700	2080	63.1	54.0					
SW 56424	129°	132°	135°	1290	575	704	909	1080	1290	1570	1820	2230	65.9	54.0						

$$\text{flow rate } L/M = K\sqrt{\text{Bar}}$$

standard material: Brass, carbon steel and 316 stainless steel

The pic given below is AASW spray nozzle joint, to join many nozzles.

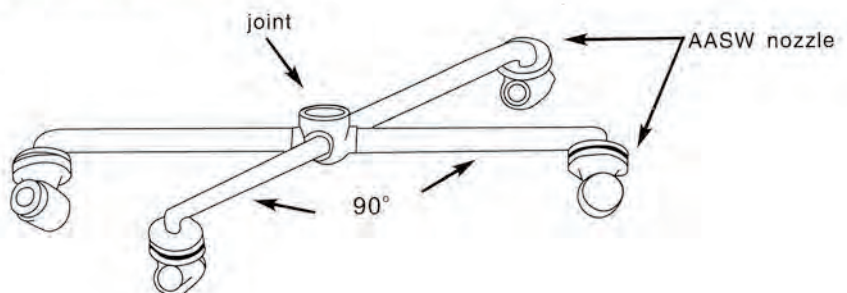



AD Series



Design features of beeline type hollow cone-shaped spray nozzle

Beeline type hollow cone-shaped spray nozzle can produce hollow cone-shaped spraying, and spray area is annular with its uniform distribution.

The nozzles spray into small liquid droplets and can avoid clogging with its large and easy passing routeway.

The spray cap can be interchanged between pipes of different size. It can produce a spray pattern of wide spray angle.

The section projection of this beeline nozzle is a bit of low when it's connected with T joint or pipe collection, it's widely used in coal ash control.

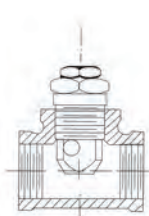
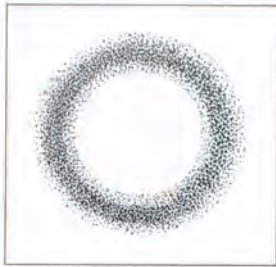

Connecting with pipe joint, T joint and connector

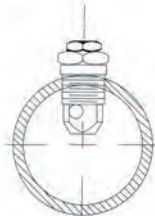

Connecting with pipe collection

size and weight

Nozzle type	A (mm)	B (mm)	C (mm)	Net weight (Kilogram)
3/8AD-	28	32	17.5six angles	0.03
1/2AD-	32.5	37.5	22.2six angles	0.06
3/4AD-	38	44.5	27.0six angles	0.11
1 1/2AD-	60.5	66.5	50.8six angles	0.60

ordering info

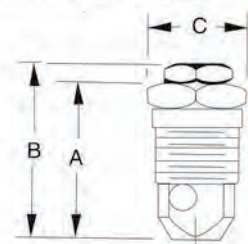
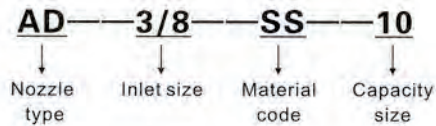

Performance data

Nozzle Inlet Conn. NPT or BSPT(out)	Nozzle Type AD	Capacity Size	Inlet Dia. No. Size (mm)	Rated Orifice Dia. (mm)	Capacity (L/min)											Spray angle		
					0.2 bar	0.5 bar	0.7 bar	1 bar	1.5 bar	2 bar	3 bar	4 bar	5 bar	6 bar	7 bar	0.5 bar	1.5 bar	6 bar
3/8	●	2	2.4	2.0			0.76	0.91	1.1	1.3	1.6	1.8	2.0	2.2	2.4		60°	70°
	●	3	2.4	2.4		0.96	1.1	1.4	1.7	1.9	2.4	2.7	3.1	3.3	3.6	52°	64°	77°
	●	5	2.8	3.2	1.0	1.6	1.9	2.3	2.8	3.2	3.9	4.6	5.1	5.6	6.0	56°	67°	76°
	●	8	4.0	4.0	1.6	2.6	3.1	3.6	4.5	5.2	6.3	7.3	8.2	8.9	9.6	56°	65°	70°
	●	10	4.0	4.4	2.0	3.2	3.8	4.6	5.6	6.4	7.9	9.1	10.2	11.2	12.1	55°	65°	72°
	●	20-10	*4.0	4.4		4.5	5.3	6.4	7.8	9.0	11.1	12.8	14.3	15.6	16.9	61°	65°	67°
1/2	●	5	3.2	3.6	1.0	1.6	1.9	2.3	2.8	3.2	3.9	4.6	5.1	5.6	6.0	63°	73°	79°
	●	8	4.0	4.0	1.6	2.6	3.1	3.6	4.5	5.2	6.3	7.3	8.2	8.9	9.6	61°	69°	73°
	●	10	4.4	4.4	2.0	3.2	3.8	4.6	5.6	6.4	7.9	9.1	10.2	11.2	12.1	63°	70°	74°
	●	15	*4.4	5.2	3.1	4.8	5.7	6.8	8.4	9.7	11.8	13.7	15.3	16.7	18.1	60°	67°	70°
	●	20	*4.8	6.0	4.1	6.4	7.6	9.1	11.2	12.9	15.8	18.2	20	22	24	63°	65°	69°
	●	25	*5.2	7.1	5.1	8.1	9.5	11.4	14.0	16.1	19.7	23	25	28	30	59°	63°	68°
3/4	●	5	3.6	3.2	1.0	1.6	1.9	2.3	2.8	3.2	3.9	4.6	5.1	5.6	6.0	64°	73°	79°
	●	8	4.4	4.0	1.6	2.6	3.1	3.6	4.5	5.2	6.3	7.3	8.2	8.9	9.6	62°	70°	74°
	●	10	5.2	4.4	2.0	3.2	3.8	4.6	5.6	6.4	7.9	9.1	10.2	11.2	12.1	64°	72°	75°
	●	15	6.4	5.6	3.1	4.8	5.7	6.8	8.4	9.7	11.8	13.7	15.3	16.7	18.1	64°	72°	74°
	●	20	7.1	6.4	4.1	6.4	7.6	9.1	11.2	12.9	15.8	18.2	20	22	24	63°	70°	74°
	●	25	7.1	7.5	5.1	8.1	9.5	11.4	14.0	16.1	19.7	23	25	28	30	63°	70°	74°
1-1/2	●	50-50.3	*7.1	9.5	10.2	16.1	19.1	23	28	32	39	46	51	56	60	70°	72°	73°
	●	40	*9.5	7.9	8.2	12.9	15.3	18.2	22	26	32	36	41	45	48	70°	73°	74°
	●	50	*9.5	9.5	10.2	16.1	19.1	23	28	32	39	46	51	56	60	72°	75°	77°
	●	60	*9.5	11.1	12.2	19.3	23	27	33	39	47	55	61	67	72	74°	76°	79°
	●	70	*9.5	12.7	14.3	23	27	32	39	45	55	64	71	78	84	76°	79°	83°
	●	80	*9.5	14.3	16.3	26	31	36	45	52	63	73	82	89	96	78°	82	84°
1-1/2	●	90	*9.5	14.7	18.3	29	34	41	50	58	71	82	92	100	109	81°	84°	84°
	●	100	*9.5	15.9	20	32	38	46	56	64	79	91	102	112	121	83°	86°	86°
	●	110	*9.5	17.1	22	35	42	50	61	71	87	100	112	123	133	85°	88°	88°
	●	120	*9.5	18.3	24	39	46	55	67	77	95	109	122	134	145	87°	90°	90°

BB Series Full Cone Spray Nozzle

standard angle series



single type(BB)

BB standard angle series spray nozzles feature a full cone spray pattern with a round impact area and spray angles between 43° and 106°.

They produce a uniform distribution of medium to large sized drops over a wide range of flow rates and pressures. Their uniform spray distribution result from a unique vane design, large and easy flow passages and superior spray control design.

Machined critically, BB series metal nozzles insure correct and dependable performance with exact sizes. They are ideal for applications requiring complete coverage to a certain area.

BB series metal nozzles have knock-down cap and vane, can be suitably connected with pipe collection and multi-pipe. Under this design way, its working-end (cap and vane) can be knocked down off the nozzle body to be overhauled and cleaned, without knocking down the nozzle body off the pipe.

standard angle series



fission type(BBG)

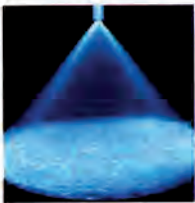

Nozzle Inlet Conn.	Capacity Size	Nozzle Type		Material code			Rated Orifice Dia. (mm)	Max. Hole Dia. (mm)	Capacity (L/min)										Spray angle								
		single type	fission type	BRASS	SS	316SS			0.2 bar	1 bar	1.5 bar	2 bar	3 bar	4 bar	5 bar	6 bar	7 bar	10 bar	0.5 bar	1.5 bar	6 bar						
1/8	1	●	●	●	●	●	0.79	0.64		0.44	0.54	0.62	0.74	0.85	0.94	1.0	1.1	1.3								58°	53°
	1.5	●	●	●	●	●	1.2	0.64	0.49	0.69	0.81	0.93	1.1	1.3	1.4	1.5	1.7	1.9	2.0	2.2	2.6	4.3	5.0	4.6	52°	65°	59°
	2	●	●	●	●	●	1.2	1.0	0.65	0.92	1.1	1.2	1.5	1.7	1.9	2.0	2.2	2.6	4.3	5.0	4.6	52°	65°	59°	43°	50°	46°
	3	●	●	●	●	●	1.5	1.0	0.98	1.4	1.6	1.9	2.2	2.5	2.8	3.1	3.3	3.9	5.2	6.5	5.9	52°	65°	59°	43°	50°	46°
	3.5	●	●	●	●	●	1.6	1.3	1.1	1.6	1.9	2.2	2.6	3.0	3.3	3.6	3.9	4.5	4.3	4.5	4.3	4.5	4.3	4.5	43°	50°	46°
	3.9	●	●	●	●	●	2.0	1.0	1.3	1.8	2.1	2.4	2.9	3.3	3.7	4.0	4.3	5.1	7.7	8.4	7.9	7.7	8.4	7.9	77°	84°	79°
1/4	5	●	●	●	●	●	2.0	1.3	1.6	2.3	2.7	3.1	3.7	4.2	4.7	5.1	5.5	6.5	5.2	6.5	5.9	52°	65°	59°	43°	50°	46°
	6.1	●	●	●	●	●	2.3	1.3	2.0	2.8	3.3	3.8	4.5	5.2	5.7	6.2	6.7	7.9	6.9	7.4	6.8	69°	74°	68°	45°	50°	46°
	6.5	●	●	●	●	●	2.38	1.6	2.1	3.0	3.5	4.0	4.8	5.5	6.1	6.7	7.1	8.4	4.5	5.0	4.6	45°	50°	46°	45°	50°	46°
	10	●	●	●	●	●	3.18	1.6	3.3	4.7	5.4	6.2	7.4	8.5	9.4	10.2	11.0	13.0	5.8	6.7	6.1	58°	67°	61°	58°	67°	61°
	12.5	●	●	●	●	●	3.2	1.6	4.1	5.8	6.8	7.7	9.3	10.6	11.8	12.8	13.7	16.2	6.9	7.4	6.8	69°	74°	68°	45°	50°	46°
	9.5	●	●	●	●	●	2.6	2.4	3.1	4.4	5.1	5.9	7.1	8.1	8.9	9.7	10.4	12.3	4.5	5.0	4.6	45°	50°	46°	45°	50°	46°
3/8	15	●	●	●	●	●	3.6	2.4	4.9	6.9	8.1	9.3	11.2	12.7	14.1	15.4	16.5	19.4	6.4	6.7	6.1	64°	67°	61°	64°	67°	61°
	20	●	●	●	●	●	4.0	2.8	6.5	9.2	10.8	12.4	14.9	17.0	18.8	20	22	26	7.6	8.0	7.3	76°	80°	73°	76°	80°	73°
	22	●	●	●	●	●	4.5	2.8	7.2	10.2	11.9	13.6	16.4	18.7	21	23	24	28	8.7	9.0	8.2	87°	90°	82°	87°	90°	82°
	16	●	●	●	●	●	3.5	3.2	5.2	7.4	8.7	9.9	11.9	13.6	15.1	16.4	17.6	21	4.8	5.0	4.6	48°	50°	46°	48°	50°	46°
1/2	25	●	●	●	●	●	4.6	3.2	8.2	11.6	13.5	15.4	18.6	21	24	26	27	32	6.4	6.7	6.1	64°	67°	61°	64°	67°	61°
	32	●	●	●	●	●	5.2	3.6	10.4	14.7	17.3	19.8	24	27	30	33	35	41	7.2	7.5	6.8	72°	75°	68°	72°	75°	68°
	40	●	●	●	●	●	6.2	3.6	13.1	18.5	22	25	30	34	38	41	44	52	8.8	9.1	8.3	88°	91°	83°	88°	91°	83°
	50	●	●	●	●	●	6.7	4.0	16.3	23.1	27	31	37	42	47	51	55	65	9.1	9.4	8.6	91°	94°	86°	91°	94°	86°

common application

- exhaust gas scrubbing
- quenching and cooling
- fire prevention and fire protection
- defoaming
- spraying applications

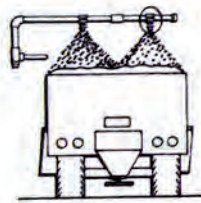

dust control

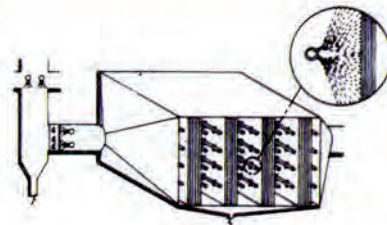

air washer

ordering info

BB 1/4 — **SS 10**
 ↓ ↓ ↓ ↓
 Single Inlet Material capacity
 nozzle size code size
 type

BBG 1/4 — **SS 10**
 ↓ ↓ ↓ ↓
 Fission Inlet Material Capacity
 nozzle size code size
 type

Remark: BRASS

SS-stainless steel

316SS-316 stainless steel

Full wide angle nozzle



single type(BBF)

Wide angle quadrate shaped spray nozzle feature a full cone spray pattern with square impact area and spray angles of 93°-115°, small-to medium-sized drops.

Unique vane design provides uniform spray distribution.

They are idea choicel for installations requiring uniform coverage of rectangular or square areas. Size1-1/4 " and larger are case-type nozzles with removable vanes.

common application

- Air and gas washers
- Cooling /quenching
- Dust control
- Fire suppression /prevention
- Liquor washers
- Product washing /rinsing
- Scrubbers

Performance data

Nozzle Inlet Conn. NPT or BSPT	Nozzle Type		Capacity Size	Rated Orifice Dia. (mm)	Max. Hole Dia. (mm)	Capacity (L/min)										Spray angle		
	single type	fission type				0.3 bar	0.5 bar	0.7 bar	1 bar	2 bar	3 bar	4 bar	5 bar	6 bar	0.5 bar	1.5 bar	6 bar	
1/8	●	●	2.8W	1.6	1.0			1.1	1.2	1.7	2.0	2.3	2.5	2.7		120°	102°	
	●	●	4.3W	2.0	1.0			1.6	1.9	2.6	3.1	3.5	3.9	4.2		120°	102°	
	●	●	5.6W	2.4	1.0			2.1	2.5	3.4	4.0	4.6	5.1	5.5		120°	102°	
	●	●	8W	2.4	1.3			2.6	3.0	3.6	4.8	5.8	6.6	7.2	7.8		120°	102°
1/4	●	●	10W	2.8	1.3	2.6	3.3	3.8	4.5	6.0	7.2	8.2	9.1	9.8	112°	120°	103°	
	●	●	12W	3.2	1.3	3.1	3.9	4.6	5.3	7.3	8.7	10.9	11.8	114°	120°	103°		
	●	●	14W	3.6	1.6	3.7	4.6	5.3	6.2	8.5	10.1	12.7	13.7	114°	120°	103°		
	●	●	14W	3.6	1.6	3.7	4.6	5.3	6.2	8.5	10.1	12.7	13.7	99°	101°	93°		
3/8	●	●	17W	4.0	1.6	4.5	5.6	6.5	7.6	10.3	12.3	13.9	15.4	16.7	114°	120°	103°	
	●	●	17W	4.0	1.6	4.5	5.6	6.5	7.6	10.3	12.3	13.9	15.4	16.7	99°	101°	93°	
	●	●	20W	4.4	2.4	5.2	6.6	6.6	8.9	12.1	14.5	16.5	18.1	19.6	114°	120°	104°	
	●	●	20W	4.4	2.4	5.2	6.6	6.6	8.9	12.1	14.5	16.5	18.1	19.6	104°	110°	94°	
1/2	●	●	24W	4.8	2.4	6.3	7.9	7.9	10.7	14.5	17.3	19.7	22	24	114°	120°	104°	
	●	●	24W	4.8	2.4	6.3	7.9	7.9	10.7	14.5	17.3	19.7	22	24	104°	110°	94°	
	●	●	27W	5.2	2.8	7.1	8.9	8.9	12.0	16.3	19.5	22	24	26	114°	120°	106°	
	●	●	27W	5.2	2.8	7.1	8.9	8.9	12.0	16.3	19.5	22	24	26	104°	110°	98°	
3/4	●	●	30W	5.6	2.8	7.9	9.9	11.4	13.4	18.1	22	25	27	29	114°	120°	108°	
	●	●	30W	5.6	2.8	7.9	9.9	11.4	13.4	18.1	22	25	27	29	104°	110°	102°	
	●	●	35W	6.0	3.2	9.2	11.5	13.3	15.6	21	25	29	32	34	114°	120°	108°	
	●	●	35W	6.0	3.2	9.2	11.5	13.3	15.6	21	25	29	32	34	104°	110°	102°	
1	●	●	40W	6.4	3.2	10.5	13.1	15.2	17.8	24	29	33	36	39	114°	120°	108°	
	●	●	40W	6.4	3.2	10.5	13.1	15.2	17.8	24	29	33	36	39	104°	110°	102°	
	●	●	45W	6.4	3.6	11.8	14.8	17.1	20	27	33	37	41	44	114°	120°	110°	
	●	●	45W	6.4	3.6	11.8	14.8	17.1	20	27	33	37	41	44	104°	110°	102°	
3/4	●	●	50W	6.7	4.0	13.1	16.4	19.1	22	30	36	41	45	49	114°	120°	112°	
	●	●	50W	6.7	4.0	13.1	16.4	19.1	22	30	36	41	45	49	104°	110°	102°	
	●	●	6W	9.9	4.4	18.4	23	27	31	42	51	58	64	69	115°	120°	112°	
	●	●	71W	9.9	4.4	18.4	23	27	31	42	51	58	64	69	105°	110°	102°	
1	●	●	11W	13.1	5.6	34	42	49	57	78	93	106	116	126	117°	120°	117°	
	●	●	130W	13.1	5.6	34	42	49	57	78	93	106	116	126	107°	110°	107°	

ordering info

BBF 1/8 — SS 2.8W

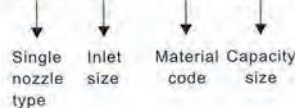

A series of nozzles for 15°



single type(BBW)

BB Series narrow angle nozzles feature a full cone spray pattern with a round impact area and spray angles of 30° or 15°.

They produce a uniform distribution of medium to large sized drops and provide significantly higher impact per unit area than wider angle nozzles at the same flow rate, and all have removable vanes.

The size 1/8" and 1-1/4" are made from steel bar while size 1-1/4" and larger are cast-in-block. Unique vane design provides superior control and uniform distribution.

Performance data

Nozzle Inlet Conn. NPT or BSPT	Nozzle Type		Capacity Size	Rated Orifice Dia. (mm)	Capacity (L/min)												Spray angle		
	single type	flission type			0.7 bar	1.5 bar	2 bar	3 bar	4 bar	5 bar	6 bar	7 bar	10 bar	20 bar	0.7 bar	3 bar	7 bar		
1/8	●	●	1507	1.6	1.3	2.0	2.3	2.8	3.2	3.6	3.9	4.2	5.0	7.1	13°	15°	15°		
	●	●	1514	2.4	2.7	3.9	4.5	5.5	6.4	7.1	7.8	8.4	10.1	14.3	13°	15°	15°		
1/4	●	●	1530	3.2	5.7	8.4	9.7	11.8	13.7	15.3	16.7	18.1	22	31	13°	15°	15°		
3/8	●	●	1550	4.4	9.5	14.0	16.1	19.7	23	25	28	30	36	51	116°	15°	15°		
1/2	●	●	1590	5.6	17.2	25	29	36	41	46	50	54	65	92	13°	15°	15°		



ordering info

BBW 1/8 — SS 1507

↓
single nozzle type

↓
Inlet size

↓
material code

↓
capacity size

A series of nozzles for 30°

Performance data

Nozzle Inlet Conn. NPT or BSPT	Nozzle Type		Capacity Size	Rated Orifice Dia. (mm)	Capacity(L/min)												Spray angle		
	single type	flission type			1 bar	2 bar	3 bar	4 bar	5 bar	6 bar	7 bar	10 bar	15 bar	20 bar	0.5 bar	1.5 bar	6 bar		
1/8	●	●	3001.4	0.79	0.32	0.45	0.55	0.64	0.71	0.78	0.84	1.0	1.2	1.4	17°	30°	31°		
	●	●	3002.5	0.79	0.57	0.81	0.99	1.1	1.3	1.4	1.5	1.8	2.2	2.5	17°	30°	32°		
	●	●	3004	1.2	0.91	1.3	1.6	1.8	2.0	2.2	2.4	2.9	3.5	4.1	26°	30°	32°		
	●	●	3007	1.6	1.6	2.3	2.8	3.2	3.6	3.9	4.2	5.0	6.2	7.1	23°	30°	30°		
1/4	●	●	3009	2.0	2.1	2.9	3.6	4.1	4.6	5.0	5.4	6.5	7.9	9.2	23°	30°	30°		
3/8	●	●	3014	2.4	3.2	4.5	5.5	6.4	7.1	7.8	8.4	10.1	12.4	14.3	25°	30°	30°		
1/2	●	●	3030	3.2	6.8	9.7	11.8	13.7	15.3	16.7	18.1	22	26	31	26°	30°	31°		
3/4	●	●	3050	4.4	11.4	16.1	19.7	23	25	28	30	36	44	51	26°	30°	31°		



single type(BBG)

ordering info

BBG 1/8 — SS — 3001.4

↓
Single nozzle type

↓
Inlet size

↓
Material code

↓
Capacity size

common application

- Cleaning and washing that requires deep penetration and / or spray induced turbulence
- Desuperheating of stream
- cleaning and cooling the inside of ducts and pipes

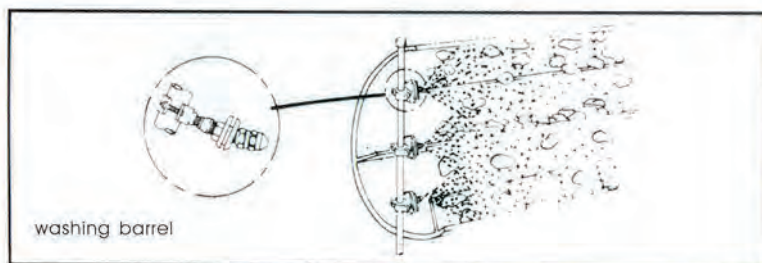

washing barrel

CC Series Flat Fan Nozzle

CC series flat fan nozzle Series



Small capacity (CC)
1/8"-1/4"
NPT or BSPT(male)



Medium capacity (CC-N)
1/8"-3/4"
NPT or BSPT(male)



Large capacity (CC-M)
1"-2"
NPT or BSPT(male)



With strainer (CC-L)
1/8"-1/4"
NPT or BSPT(male)

Design features

CC flat fan spray nozzles feature a high impact solid stream or a flat fan spray pattern with the spray angles between 0°-110°.

They produce a uniform distribution of small to medium sized drops. Properly aligned, the specially tapered spray edges make a evenly coverage.

CC and CC-L series nozzles have external piping thread connector and their flow rate are lower than 3.9 l/min at 3 bar. Inner strainer is available for CC-L Series nozzle with male connector only.

Standard flow rates of CC-N and CC-M Series are 3.9 l/min or larger at 3 bar. All have external piping thread connector.



Common application

- Chemical cleaning
- Product washing /rinsing
- Pressure cleaning
- cooling and quenching
- Fire suppression / prevention
- Fire fighting
- Net blanket low pressure cleaning
- Spray coating
- Roller and scraper ordering

Fan ceramic core



CCTC

Fan tungalloy



CTCK

Jet stabilizer for reducing turbulence



ordering info

Jet stabilizer type

CY21370—SS—1/8x1/8

↓ ↓ ↓
Jet stabilizer Material Connection
type code dimension

ordering info

CC 1/4—SS 6505

↓ ↓ ↓ ↓
Nozzle Inlet Material Capacity
type size code size
Remark:
BRASS
SS-stainless steel
316SS-316 stainless steel

Jet stabilizer type

Jet stabilizer for reducing turbulence number	Inlet Conn. NPT or BSPT	Nozzle Inlet Conn. NPT or BSPT(in)	High(mm)	Net weight (kg)
CY21370-1/8x1/8	1/8	1/8	19	0.007
CY21370-1/4x1/4	1/4	1/4	24	0.01
CY21370-3/8x3/8	3/8	3/8	27	0.03
CY21370-1/8x1/8	1/2	1/2	32	0.05
CY21370-1/2x1/2	3/4	3/4	38	0.10
CY21370-1x1	1	1	46	0.18
CY21370-1 1/4x1 1/4	1 1/4	1 1/4	57	0.33

Design features

Jet stabilizers installed in the heads of flat fan spray nozzle increase the spray distance and the durative power. When spray nozzles are installed on T-shape pipe, branching pipe or bend pipe and the fluid swerve into the nozzle, turbulence occurs, which diffuses the jet flow. The stabilizer minimize the diffusion and concentrate the jet flow through a thinner and stabler way, offering a better performance in jet distance and durative power.

Common Wide-angle Spray Nozzle

W

Nozzle Dimension

Nozzle type		
Nozzle Dimension	Hexagon l(mm)	Nozzle length (mm)
1/8	14.3	31
1/4	14.3	34

Common application

- Clarify board of spraying air
- Cooling conveyer belt
- Film development
- Fire proofing
- Water curtain

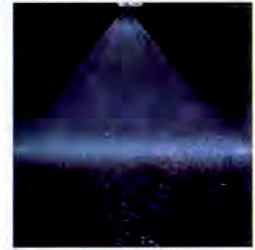

1/8"-1" NPT
or BSPT(male)

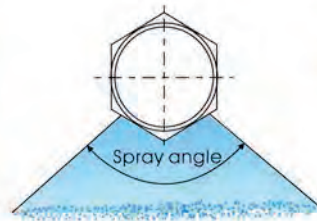

Dimension and weight

For the highest for each style:

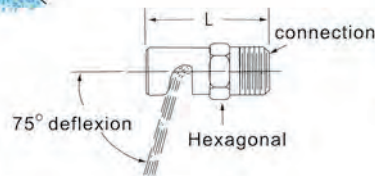

W Common Wide-angle Spray Nozzle design features

W Common Wide-angle Spray Nozzle can produce secondary wide-angle sector spraying shape and uniform spraying drop. The round spray hole and large flow channel offer you least barrier.

It can also be applied in spraying of air or steam. The nozzles have precise diversion area, to well master the slanting angle and spraying angle.

It is made of firm stick with a outer inlet joint.

Performance data

Air and steam

Capacity Size	Rated Orifice Dia. (mm)	Air capacity (L/ min)				Steam capacity (L/ min)				The coverage of 150mm	
		0.7bar	1.5bar	3bar	3.5bar	0.7bar	1.5bar	3bar	3.5bar	0.7bar	1.5bar
0.50	0.61	4.5	6.4	10.5	11.6	0.16	0.23	0.37	0.41	51	127
0.75	0.71	6.2	9.1	14.7	16.7	0.23	0.33	0.53	0.66	64	140
1	0.84	9.6	13.7	22	25	0.34	0.49	0.80	0.90	76	152
1.5	1.04	15.3	22	36	40	0.54	0.78	1.3	1.5	89	165
2	1.17	19.3	28	45	51	0.68	1.0	1.6	1.8	102	190
2.5	1.32	27	37	60	71	0.95	1.3	2.1	2.5	102	190
3	1.45	31	47	77	85	1.1	1.7	2.7	3.0	127	203
4	1.65	40	57	85	108	1.4	2.0	3.1	3.9	127	228
5	1.85	54	76	124	139	1.9	2.7	4.5	5.0	152	267
7.5	2.31	79	117	189	210	2.9	4.2	6.8	7.6	152	267
10	2.64	110	159	255	290	3.9	5.7	9.2	10.4	178	279
15	3.28	181	260	420	475	6.5	9.3	15.0	17.1	178	305
20	3.76	225	325	520	590	8.0	11.6	18.8	21	216	368
30	4.57	320	465	760	850	11.6	16.8	27	30	216	394

A Series Common Nozzle

Liquid

Nozzle Inlet Conn. NPT or BSPT(male)						Capacity Size	Rated Orifice Dia. (mm)	Capacity (L/min)										Spray angle		
1/8	1/4	3/8	1/2	3/4	1			0.2 bar	0.3 bar	0.5 bar	0.7 bar	1 bar	1.5 bar	2 bar	3 bar	4 bar	0.5 bar	1.5 bar	4 bar	
●						0.25	0.41				0.11	0.14	0.16	0.20	0.23		83°	117°		
●		●				0.50	0.61				0.23	0.28	0.32	0.39	0.46		89°	122°		
●		●				0.75	0.71			0.29	0.34	0.42	0.48	0.59	0.68		106°	125°		
●	●	●				1	0.84			0.38	0.46	0.56	0.64	0.79	0.91		109°	128°		
●		●				1.5	1.0			0.48	0.57	0.68	0.84	0.97	1.2	1.4	73°	108°	125°	
●	●	●				2	1.2			0.64	0.76	0.91	1.1	1.3	1.6	1.8	83°	113°	129°	
●	●	●				2.5	1.3		0.62	0.81	0.95	1.1	1.4	1.6	2.0	2.3	98°	122°	133°	
●	●	●				3	1.4		0.75	0.97	1.1	1.4	1.7	1.9	2.4	2.7	86°	112°	126°	
●		●				4	1.7		1.0	1.3	1.5	1.8	2.2	2.6	3.2	3.6	97°	123°	132°	
●	●	●				5	1.9	1.0	1.2	1.6	1.9	2.3	2.8	3.2	3.9	4.6	114°	128°	142°	
●	●	●				7.5	2.3	1.5	1.9	2.4	2.9	3.4	4.2	4.8	5.9	6.8	101°	119°	134°	
●	●	●				10	2.6	2.0	2.5	3.2	3.8	4.6	5.6	6.4	7.9	9.1	115°	133°	145°	
●	●	●				12	2.9	2.4	3.0	3.9	4.6	5.5	6.7	7.7	9.5	10.9	128°	139°	153°	
●	●	●				15	3.3	3.1	3.7	4.8	5.7	6.8	8.4	9.7	11.8	13.7	98°	113°	123°	
●	●	●				18	3.6	3.7	4.5	5.8	6.9	8.2	10.0	11.6	14.2	16.4	106°	120°	131°	
●	●	●				20	3.8	4.1	5.0	6.4	7.6	9.1	11.2	12.9	15.8	18.2	110°	122°	133°	
	●					22	4.0	4.5	5.5	7.1	8.4	10.0	12.3	14.2	17.4	20	113°	125°	136°	
	●					24	4.1	4.9	6.0	7.7	9.2	10.9	13.4	15.5	18.9	22	115°	131°	144°	
	●					27	4.4	5.5	6.7	8.7	10.3	12.3	15.1	17.4	21	25	119°	135°	148°	
		●				30	4.6	6.1	7.5	9.7	11.4	13.7	16.7	19.3	24	27	100°	110°	121°	
		●				35	5.0	7.1	8.7	11.3	13.3	16.0	19.5	23	28	32	105°	118°	128°	
		●	●			40	5.3	8.2	10.0	12.9	15.3	18.2	22	26	32	36	111°	126°	136°	
		●				45	5.6	9.2	11.2	14.5	17.2	21	25	29	36	41	115°	130°	140°	
			●			50	6.0	10.2	12.5	16.1	19.1	23	28	32	39	46	117°	131°	140°	
			●			60	6.5	12.2	15.0	19.3	23	27	33	39	47	55	120°	134°	142°	
			●		●	70	7.1	14.3	17.5	23	27	32	39	45	55	64	123°	137°	146°	
			●		●	80	7.5	16.3	20	26	31	36	45	52	63	73	127°	138°	149°	
	●				●	90	8.0	18.3	22	29	34	41	50	58	71	82	120°	133°	140°	
	●				●	100	8.4	20	25	32	38	46	56	64	79	91	123°	136°	145°	
	●				●	110	8.8	22	27	35	42	50	61	71	87	100	125°	138°	148°	
		●			●	120	9.3	24	30	39	46	55	67	77	95	109	129°	143°	150°	
		●			●	140	10.3	29	35	45	53	64	78	90	111	128	118°	127°	135°	
		●			●	160	11.1	33	40	52	61	73	89	103	126	146	121°	130°	137°	
			●		●	180	11.5	37	45	58	69	82	100	116	142	164	124°	133°	139°	
			●		●	210	12.3	43	52	68	80	96	117	135	166	191	128°	139°	145°	
			●		●	300	14.7	61	75	97	114	137	167	193	235	275	110°	128°	135°	
					●	450	17.9	92	112	145	172	205	250	290	355	410	118°	132°	138°	

ordering info

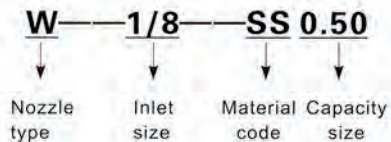

Remark:
 BRASS
 SS-stainless steel
 316SS-316 stainless steel
 PVC-Poly(vinyl chloride)
 PP-Poly propylene

SJV Three-piece Full Cone Flat Fan Spray Nozzle



SJVC spray tip



SJVW
Wide angle spray tip



SJVB
Full cone spray tip



SJVA
Hollow cone spray tip

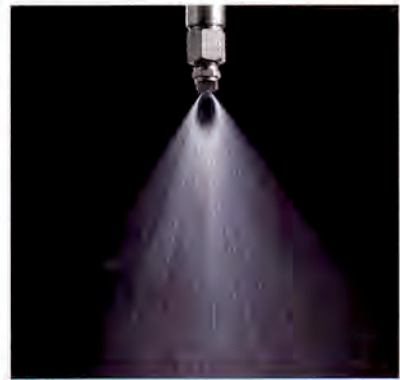

Design features

High pressure, High impact solid stream or flat fan spray pattern with spray angles of 0° to 110°.

Spray pattern with uniform distribution, Small to medium sized drops. Specially uniform distribution with spray area is ideal for use in manifold and header applications.

All SJVC nozzle are finish machining. It can provide the accurate flow and spray angle.

SJVW provide wide angle flat fan atomization, SJVB provide standard solid cone atomization and SJVA provide taper atomization.

common application

- Low pressure washing
- Chemotherapy coating
- Metal cleaning and precessing
- Spray coating
- Degreasing and rinsing
- Parts washing /cleaning
- Spray cooling
- Pressure cleaning
- Sand, coal ,gravel washing

Nozzle body

Nozzel and gasket 's material consist of brass ,303SS and 316SS. The inlet connection thread (NPT or BSPT)size is 1/8" , 1/4" , 3/8" and 1/2" (Male or female)

Inlet Conn. NPT or BSPT	Nozzle parts order NO.		Material
	(female)	(male)	
1/8	1/8QJ	1/8QJJ	Brass
	1/8QJ-SS	1/8-QJJ-SS	ss
1/4	1/4QJ	1/4QJJ	Brass
	1/4QJ-SS	1/4QJJ-SS	ss
3/8	3/8QJ	3/8QJJ	Brass
	3/8QJ-SS	3/8QJJ-SS	ss
1/2	1/2QJ	1/2QJJ	Brass
	1/2QJ-SS	1/2QJJ-SS	ss

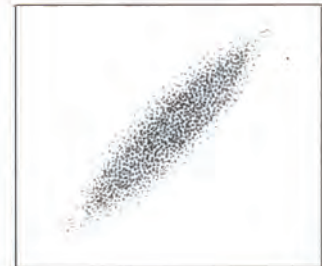

Strainer information

The choice for the orifice of the strainer	
Equivalent spray orifice	Suggested size of steel strainer's orifice
less than 0.46mm	200
47mm -0.79mm	100
0.8mm or larger	50



MG
Tip retainer



GLQ
Screen strainer



SJVE
MALE body



SJVL
Female body

ordering info

SJVE + SJVC - 11001 - SS

Thread body | Nozzle type | Capacity size | Material code

SJVE + GLQ + SJVC + 11001 - SS

Thread body | Strainer | Nozzle type | Capacity size | Material code

SJVE + GLQ + SJVW + 11005 - SS

Thread body | Strainer | Wide angle spray tip | Capacity size | Material code

QJJ SS Dismantling Nozzle

QB



full cone quick dismantling nozzle tip



Gasket



1/4-1/2QJJ
Male nozzle body

QC



flat fan quick dismantling nozzle tip



Gasket



1/4-1/2QJJ
male nozzle body

QCL



narrow angle flat fan nozzle tip



Gasket



1/8-1/2 QJ
female nozzle body

QV



narrow angle flat fan quick dismantling nozzle tip



Gasket



1/8-1/2 QJ
female nozzle body



standard flat fan



solid stream



narrow angle flat fan



full cone

Design features

Flat fan spray nozzle is time-saving, which is quick-install with inlet connect size of 1/4" and 1/8", and automatically adjusting spray pattern. QCL nozzle can have the flow rate of 3.9 l/min under 3 bar pressure. QC/QB can have the flow rate of 3.9 l/min or above. They are the perfect choice when the device is small and light.

Common application

- chemical spraying
- low pressure washing
- PCB manufacturing
- product washing and rinsing
- cooling
- moistening
- chemical manufacturing
- dust control

inlet connection NPT or BSPT	standard model of nozzle body	
	(Female)	(Male)
	QJ	QJJ
1/8		●
1/4		●
3/8	●	
1/2	●	

ordering info

QB — 1/4 — SS — 11010

Nozzle type Inlet size Material code Capacity size

QJJ Plastic Dismantling Nozzle

Design features

Easy nozzle replacement

Easy dismantling nozzle design, the nozzle and spray head can be quickly dismantled. You can rotate the spray head by 90 degrees to install it or split it from the nozzle by hand. So it can significantly reduce downtime during maintenance.

Auto orienting spray head

There is an interior block, which can keep the nozzle in the right position without manual adjustment. Therefore, it can avoid quality problems caused by the wrong orientation of the nozzle.

Anti-corrosion and wear-resistant

Easy split nozzle; Made of Glass Fiber PP (25%), Carbon Fiber PP (40%) and PVDF, featuring high intensity, wearability and anticorrosion; Suitable for washing and rinsing of corrosive solutions, such as phosphate, acid & solvent; Max temperature for Glass Fiber PP is 82°C; Max temperature for Carbon Fiber is 120°C; While PVDF is high purity without pigment which can keep high purity in processing, and the max temperature is 148°C under 7kg pressure.

Widely capacity choice.

Available sizes: 1/8", 1/4" and 3/8"; Absolutely windtight between nozzle and spray head with an interior O-shaped NBR windtight circle; Easy Split Nozzle; Special appearance of spray head for grasp; Available spray head shapes: QC flat fan, QB full cone and QA hollow cone; and various capacities & angles are available.



Performance data



Easy-dismantling Flat Fan Spray Tip

nozzle type (Spraying angle under 3 bar pressure)					Capacity (L/min)									
50°	65°	80°	95°	110°	0.3bar	1bar	2bar	3bar	4bar	5bar	6bar	7bar	14bar	
QC5001	QC6501	QC8001	QC9501	QC11001	0.12	0.23	0.32	0.39	0.46	0.51	0.56	0.60	0.85	
QC5002	QC6502	QC8002	QC9502	QC11002	0.25	0.45	0.64	0.79	0.91	1.0	1.1	1.2	1.7	
QC5003	QC6503	QC8003	QC9503	QC11003	0.37	0.69	0.97	1.2	1.4	1.5	1.7	1.8	2.6	
QC5004	QC6504	QC8004	QC9504	QC11004	0.50	0.92	1.3	1.6	1.8	2.0	2.2	2.4	3.4	
QC5005	QC6505	QC8005	QC9505	QC11005	0.62	1.1	1.6	2.0	2.3	2.5	2.8	3.0	4.3	
QC5006	QC6506	QC8006	QC9506	QC11006	0.75	1.3	1.9	2.4	2.7	3.1	3.3	3.6	5.1	
QC5008	QC6508	QC8008	QC9508	QC11008	1.0	1.8	2.6	3.2	3.6	4.1	4.5	4.8	6.8	
QC5010	QC6510	QC8010	QC9510	QC11010	1.2	2.3	3.2	3.9	4.6	5.1	5.6	6.0	8.5	
QC5015	QC6515	QC8015	QC9515	QC11015	1.9	3.4	4.8	5.9	6.8	7.6	8.4	9.0	12.8	
QC5020	QC6520	QC8020	QC9520	QC11020	2.5	4.6	6.5	7.9	9.1	10.2	11.2	12.1	17.1	
QC5030	QC6530	QC8030	QC9530	QC11030	3.7	6.8	9.7	11.8	13.7	15.3	16.7	18.1	26	



Fan Fan

Easy-dismantling Full Cone Spray Tip

nozzle type	Capacity (L/min)										Spray angle		
	0.5bar	0.7bar	1.5bar	2bar	3bar	4bar	5bar	6bar	7bar	10bar	0.5bar	1.5bar	6bar
QB1	0.25	0.38	0.54	0.62	0.74	0.85	0.94	1.0	1.1	1.3	—	58°	53°
QB2	0.65	0.76	1.0	1.2	1.5	1.7	1.9	2.0	2.2	2.6	43°	50°	46°
QB3	0.98	1.1	1.6	1.9	2.2	2.5	2.8	3.1	3.3	3.9	52°	65°	59°
QB3.5	1.1	1.3	1.9	2.2	2.6	3.0	3.3	3.6	3.9	4.5	43°	50°	46°
QB5	1.6	1.9	2.7	3.1	3.7	4.2	4.7	5.1	5.5	6.5	52°	65°	59°
QB6.5	2.1	2.5	3.5	4.0	4.8	5.5	6.1	6.7	7.1	8.4	45°	50°	46°
QB10	3.3	3.8	5.4	6.2	7.4	8.5	9.4	10.2	11.0	13.0	58°	67°	61°

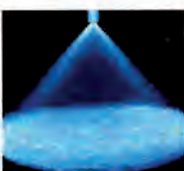

Full Cone

C Series Quick Dismantling Nozzle

Easy-dismantling Hollow Cone Spray Tip



Hollow Cone

nozzle type	Capacity (L/min)										Spray angle		
	0.2bar	0.5bar	1bar	1.5bar	2bar	3bar	4bar	5bar	6bar	7bar	0.5bar	1.5bar	6bar
QA0.5	—	0.16	0.23	0.28	0.32	0.39	0.46	0.51	1.56	0.60	—	58°	69°
QA1	—	0.32	1.46	0.56	0.64	0.79	0.91	1.0	1.1	1.2	—	65°	76°
QA2	—	0.64	0.91	1.1	1.3	1.6	1.8	2.0	2.2	2.4	53°	70°	80°
QA3	—	0.97	1.4	1.7	1.9	2.4	2.7	3.1	3.3	3.6	55°	79°	80°
QA5	—	1.6	2.3	2.8	3.2	3.9	4.6	5.1	5.6	6.0	70°	75°	79°
QA8	1.6	2.6	3.6	4.5	5.2	6.3	7.3	8.2	8.9	9.6	65°	72°	74°
QA10	2.0	3.2	4.6	5.6	6.4	7.9	9.1	10.2	11.2	12.1	70°	76°	75°
QA15	3.1	4.8	6.8	8.4	9.7	11.8	13.7	15.3	16.7	18.1	70°	72°	75°
QA5W	—	1.6	2.3	2.8	3.2	3.9	4.6	5.1	5.6	6.0	125°	112°	98°
QA8W	1.6	2.6	3.6	4.5	5.2	6.3	7.3	8.2	8.9	9.6	112°	100°	87°
QA10W	2.0	3.2	4.6	5.6	6.4	7.9	9.1	10.2	11.2	12.1	111°	97°	89°
QA15W	3.1	4.8	6.8	8.4	9.7	11.8	13.7	15.3	16.7	18.1	110°	98°	90°

common application

- PCB
- Wash & Rinse
- Phosphatization for metal parts
- Cooling
- Moistening
- Chemical Manufacture
- Dust Removing

ordering info

nozzle type	Nozzle Inlet Conn. (Inch)
QJJ1/8	1/8
QJJ1/4	1/4
QJJB1/4	1/4(angle fitting)
QJJ3/8	3/8

Please mark out nozzle model and spray tip model

For Example:

Nozzle Model:QJJ1/4-PP

Spray tip Model:QB5-PP

Complete nozzle model:

QJJ1/4-PP+QB5-PP



Plastic nozzle



Plastic nozzle tip



Gasket



Gasket



Nozzle body



Nozzle body

D Series Atomizing Nozzle

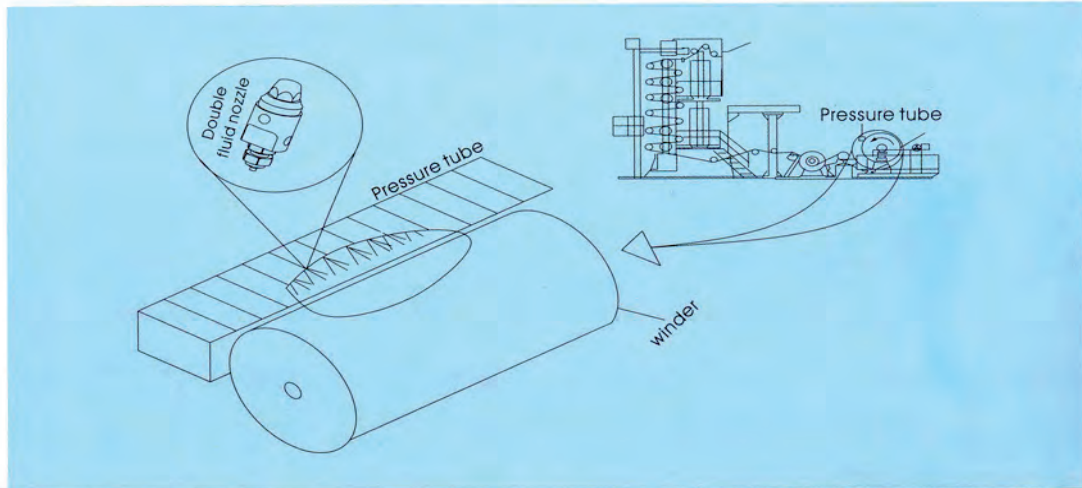
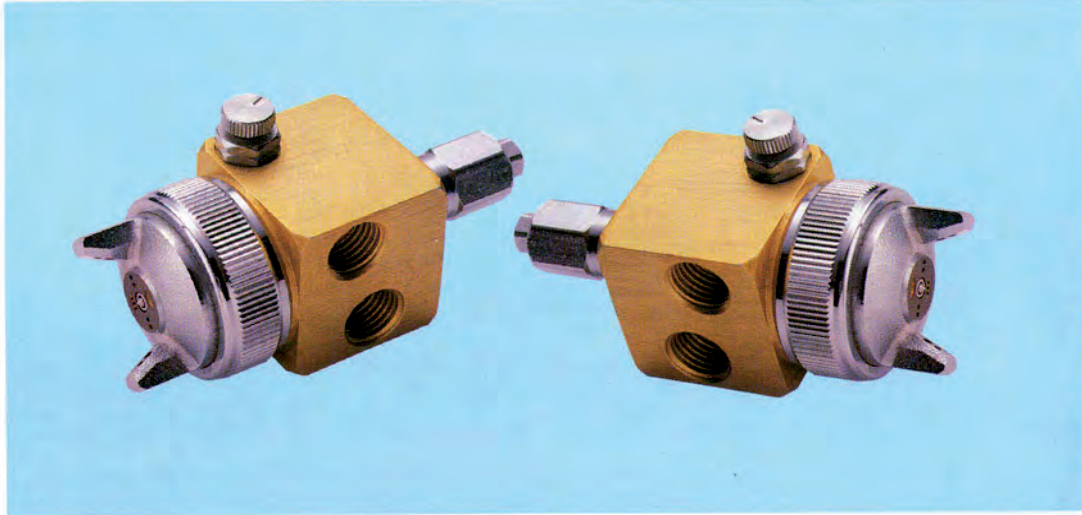
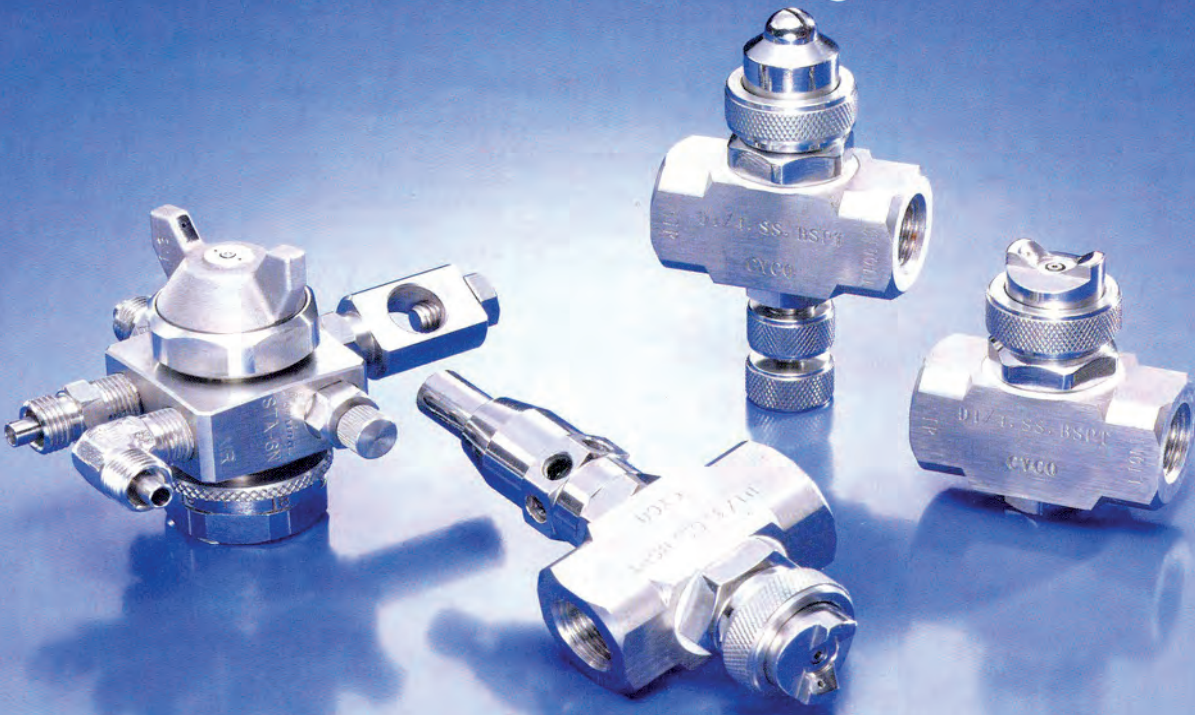

Air Atomizing Nozzle

Design features

D Atomizing Nozzle has special interior structure, which can evenly mix liquid & gas and generate tiny spraying drop or large spraying drop. In common situation, we can get super tiny (about 30mm) liquid spraying drop by air pressure increasing or hydraulic pressure decreasing. Adjustable Atomized can adjust liquid capacity. It can meet the requirement of spraying without changing air pressure and hydraulic pressure. Therefore, it has good adaptability. Each spray device is composed of air cap and liquid cap, which can offer two spray modes, flat fan and round, with wide liquid capacity coverage. Various available sizes of inlet joint for spray nozzle. It is flexible with changeable parts. Atomizing Nozzle has good moisture effect. It is the ideal choice for the location where requires moisture control.



common application

- Wool Spraying & Moisturization
- Mould Lubricating
- Spraying Injection
- Air Disinfection



Efficient Moisture
Ideal choice of location with efficient moisture

Structure

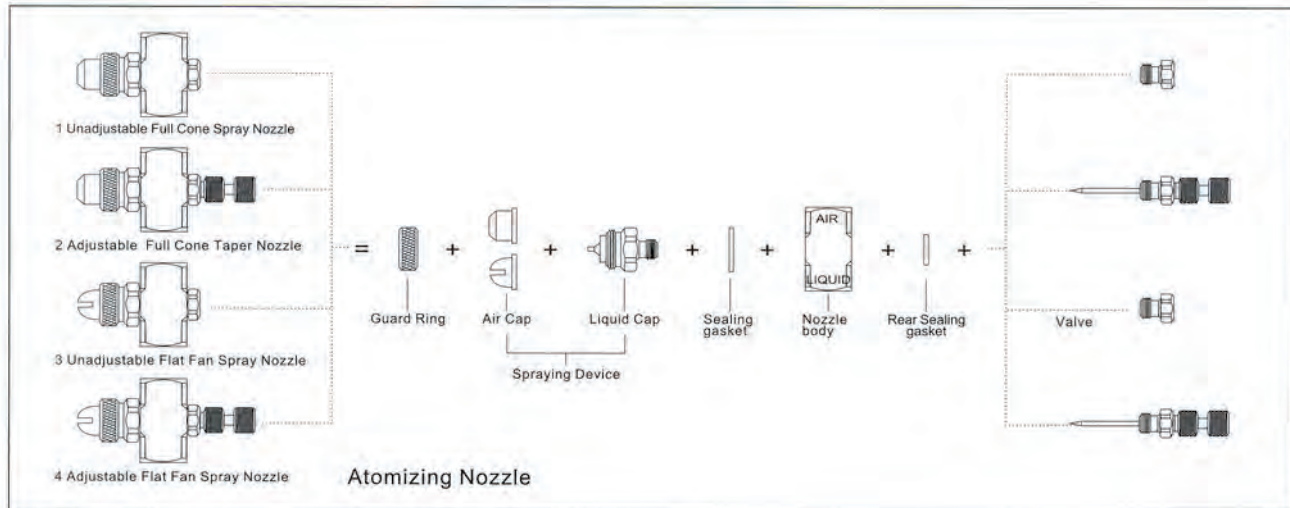

Pressure Air Atomizing

Performance data

For flat spray, A/B/C size is the distance to nozzle, while "D" is the maximum. distance to nozzle as the right chart.

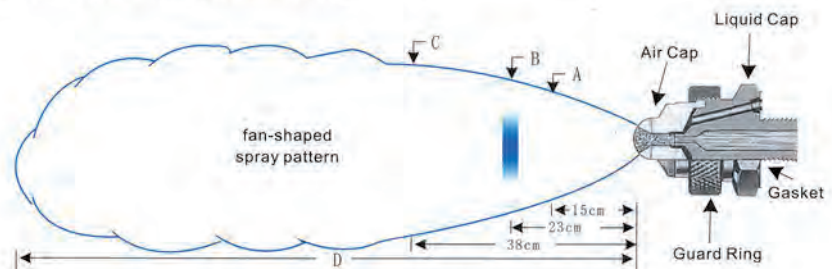

For round spray, the spray angle "A" is maintained within the distance of "B", the spraying will turn into torrent if the distance has reached "D", as the right chart

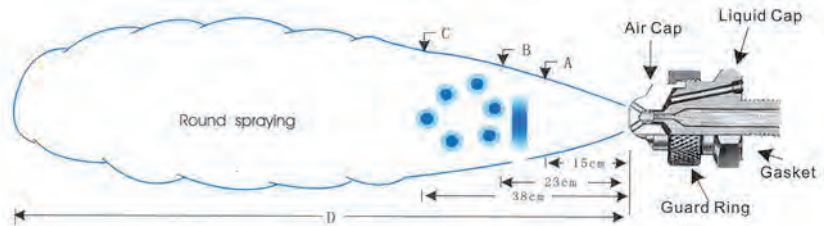

Wide-angle round spray

Performance date

spray device model	spray device consists of air cap and fluid cap	liquid flow (L/min) and flow (L/min)																Size							
		Water pressure (bar)																Air (bar)	Liquid (bar)	A (cm)	B (cm)	C (cm)	D (cm)		
		0.7bar				1.5bar				2bar				3bar										4bar	
Air pressure (bar)	Water (L/h)	Air (L/min)	Air pressure (bar)	Water (L/h)	Air (L/min)	Air pressure (bar)	Water (L/h)	Air (L/min)	Air pressure (bar)	Water (L/h)	Air (L/min)	Air pressure (bar)	Water (L/h)	Air (L/min)	Air pressure (bar)	Water (L/h)	Air (L/min)								
SUK16	Liquid Cap 2050 and Air Cap 67-6-20-70°	0.6	5.3	10.2	1.1	6.1	13.3	1.5	8.1	16.4	2.4	8.9	22	3.1	10.5	24	0.7	0.7	14	18	23	1.5			
		0.7	4.3	12.2	1.3	7.0	15.0	1.8	6.6	21	2.7	8.1	26	3.4	9.7	28	1.4	1.5	15	19	24	1.8			
		0.85	3.0	14.2	1.4	6.4	17.0	2.1	4.9	25	3.0	6.4	30	3.9	7.8	36	1.8	2.0	16	20	25	2.1			
SUK26B	Liquid Cap 60100 and Air Cap 140-6-37-70°	1.0	1.7	17.0	1.5	5.5	19.0	2.4	3.2	29	3.2	4.9	34	4.2	6.1	42	3.0	3.0	16	20	26	2.7			
					1.7	4.5	22							3.4	4.2	37	4.6	4.4	47	3.9	4.0	19	23	30	4.0
					1.8	3.5	24							3.5	3.4	40	4.9	2.8	54						
SUK26	Liquid Cap 60100 and Air Cap 140-6-37-70°	0.85	7.0	5.0	1.7	13.2	68	2.0	18.5	68	2.8	25	84	3.7	31	96									
		1.0	2.1	62	1.8	9.8	79	2.1	15.1	76	3.0	22	92	3.8	28	105	0.85	0.7	18	24	31	1.8			
								2.2	11.7	85	3.1	18.5	101	3.9	26	113	1.7	1.5	19	25	33	2.4			
SUK29	Liquid Cap 60100 and Air Cap 140-6-52-70°																								
SUK30	Liquid Cap 40100 and Air Cap 120-6-35-60°	0.7	24	32	1.4	43	37	2.1	33	66	2.8	52	76	3.7	63	68							36		
		0.85	13.6	44	1.5	35	49	2.2	26	78	3.0	46	87	3.8	68	79	1.85	0.7	19	25	37	2.1			
		1.0	7.6	57	1.7	28	61	2.4	18.9	89	3.1	39	99	4.1	23	122	2.1	2.0	19	25	33	3.2			
SUK46	Liquid Cap 100150 and Air Cap 189-6-62-70°																								

Typical Moisturization Design

You can freely adjust spraying drop and liquid capacity for best spraying effect.

Remark: Fast joint is used for liquid and air connecting and common air/water pipe Dia. is 8-6mm.

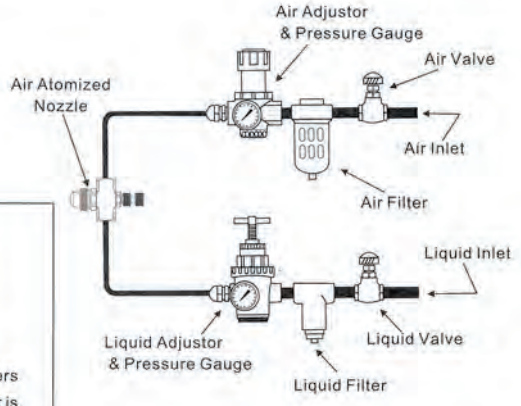

ordering info

D-1/4-SS+SUC13-SS

↓ ↓ ↓ ↓ ↓

nozzle type Inlet size material code The number of spraying device capacity size

Remark:
BRASS
SS-stainless steel
316SS-316 stainless steel
Please contact our sales engineers for detail. Besides, customized order is available.

D Series Air Atomizing Nozzle

Siphon Gravity-Fed Air Atomizing Nozzle

Design features

For those nozzle of round and flat spray pattern, the spray can maintain the spray angle of A when it is within the distance of B. If beyond the distance of B, the spray would turn to torrent, and jet to the distance of D.

When using siphon or gravity-fed fluid system, it can be supplied to the fluid by siphon or gravity-fed. In these devices, the fluid is absorbed and sent to the gas stream through conveyer where it is atomized in the gas stream.

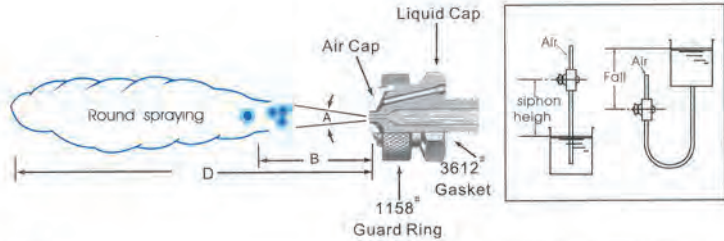

The air cap of round or flat fan pattern produces round or flat fan pattern spraying.

* No. 1158 and No.3162 gaskets should be ordered separately from the spray device, but they are also parts of the standard spray nozzle.

round spray

spray device model	spray device consists of air cap and fluid cap	atomized air		fluid volumn(L/H)							spray dimensions of 20cm siphon height.				
		air pressure bar	air volumn (L/Min)	Gravity-head			siphon heigh				air pressure bar	Spray angle A	B (CM)	D (CM)	
				45 (CM)	30 (CM)	15 (CM)	10 (CM)	20 (CM)	30 (CM)	60 (CM)					90 (CM)
SU1A	Liquid Cap1650 and Air Cap 64	0.7	11.3	1.5	1.3	1.1	0.87	0.68	0.53		0.76	0.7	18°	28	1.8
		1.5	17.0	1.8	1.7	1.5	1.3	1.2	1.1	0.62	0.87	1.5	18°	28	1.9
		3.0	28	2.1	1.9	1.7	1.5	1.4	1.3	1.1		3.0	18°	30	2.3
		4.0	36	2.2	2.0	1.8	1.6	1.5	1.4	1.2		4.0	18°	36	2.6
SU1	Liquid Cap2050 and Air Cap64	0.7	13.3	2.4	2.1	1.7	1.5	1.2	0.79			0.7	18°	30	2.1
		1.5	20	2.8	2.6	2.4	2.1	1.9	1.6	0.91		1.5	18°	33	2.3
		3.0	32	3.4	3.1	2.9	2.8	2.6	2.4	1.7	1.2	3.0	18°	38	2.6
		4.0	41	3.7	3.4	3.3	3.1	2.9	2.7	2.1	2.0	4.0	19°	43	3.0
SU2A	Liquid Cap2050 and Air Cap 70	0.7	23	2.5	2.3	2.0	1.6	1.4	1.1				18°	30	2.4
		1.5	36	2.9	2.8	2.5	2.2	2.0	1.7	0.89			18°	33	2.7
		3.0	58	3.4	3.3	3.2	2.9	2.8	2.5	1.9			19°	38	3.4
		4.0	74	3.7	3.6	3.5	3.4	3.3	3.0	2.5	1.1	1.2	20°	43	4.0
SU2	Liquid Cap 2850 and Air Cap 70	0.7	19.3	4.5	4.0	3.4	2.1	1.8	1.4		1.5	2.0	21°	38	4.6
		1.5	31	5.3	4.9	4.4	3.5	2.9	2.7	1.8	1.2		21°	41	3.0
		3.0	50	6.0	5.6	5.0	4.4	4.0	2.4	2.4	2.0		21°	46	3.4
		4.0	65	5.7	5.4	5.0	4.2	3.9	3.5	2.8		1.2	22°	51	4.6
SU4	Liquid Cap 60100 and Air Cap 120	1.5	58	22	19.9	16.3	12.3	10.5	8.3	2.8	1.2	1.9	17°	46	3.7
		3.0	88	25	23	19.5	16.7	14.2	11.5	6.4	1.9		18°	51	4.3
		4.0	111	26	24	21	18.4	15.7	12.9	7.9	2.8	2.8	18°	53	4.9
		5.6	147	26	24	22	19.7	17.0	14.6	9.8	4.5	4.5	19°	58	5.5
SU5	Liquid Cap100150 and Air Cap 180	2.0	144				27	22	16.8		6.1	6.1	20°	51	6.7
		3.0	190				30	26	21				20°	53	7.0
		4.0	240		43	40	31	28	23	11.0			21°	58	7.6
		5.6	315	44	42	39	31	28	24	16.7	8.3	8.3	22°	63	8.2

flat spray

spray device model	spray device consists of air cap and fluid cap	atomized air		fluid volumn(L/H)							spray dimensions of 20cm siphon height.					
		air pressure bar	air volumn (L/Min)	Gravity-head			siphon heigh				Air pressure bar	A (CM)	B (CM)	C (CM)	D (CM)	
				45 (CM)	30 (CM)	15 (CM)	10 (CM)	20 (CM)	30 (CM)	60 (CM)						90 (CM)
SUF1	Liquid Cap2850 and Air Cap 73420	0.7	28	1.3	1.2	1.1	1.0	0.95	0.83	0.64	0.49	0.7	20	26	38	2.1
		1.5	43	1.2	1.1	1.0	0.90	0.86	0.78	0.66	0.54	1.5	21	29	38	2.1
		2.0	50	0.82	0.76	0.68	0.57	0.50				2.0	23	30	38	1.8
SUF2C	Liquid Cap35100 and Air Cap 120432	1.5	56	3.7	3.5	3.3	2.9	2.8	2.5	2.3	2.1	1.5	23	32	38	2.7
		2.0	65	3.4	3.3	3.1	2.8	2.7	2.6	2.4	2.2	2.0	24	34	42	2.7
		3.0	87	2.8	2.7	2.5	2.4	2.2	2.1	1.9	1.7	3.0	27	37	46	3.0
		4.0	110	1.9	1.8	1.6	1.5	1.3	1.2			4.0	28	39	48	2.7
SUF3B	Liquid Cap 40100 and Air Cap 122435	1.5	68	5.1	4.8	4.5	3.8	3.7	3.5	3.0	2.4	1.5	19	23	27	3.4
		2.0	78	4.9	4.7	4.4	3.6	3.4	3.2	2.9	2.3	2.0	20	25	28	3.4
		3.0	103	3.4	3.2	3.0	2.2	2.0	1.7			3.0	22	27	30	3.0
		3.5	117	2.2	2.0	1.7										
SUF4B	Liquid Cap40100 and Air Cap 122440	1.5	63	7.6	7.2	6.6	5.7	5.4	5.1	4.6	3.7	1.5	17	22	27	3.4
		2.0	73	7.6	7.3	6.8	5.9	5.7	5.5	5.0	4.2	2.0	18	23	29	3.4
		3.0	96	6.4	6.1	5.7	5.0	4.5	4.1	3.3		3.0	20	27	33	3.4
		3.5	110	4.2	3.7	3.2	2.6									

Flat Pressure Air Atomizing(external mix)

Design features

With the external mixing, the air pressure can be changed to control atomizing without changing the liquid flow rate. As the picture shown, size 'A' is the flow width of fan-shaped spraying, 'D' is the total distance from the nozzle body to the maximum dispersing area.

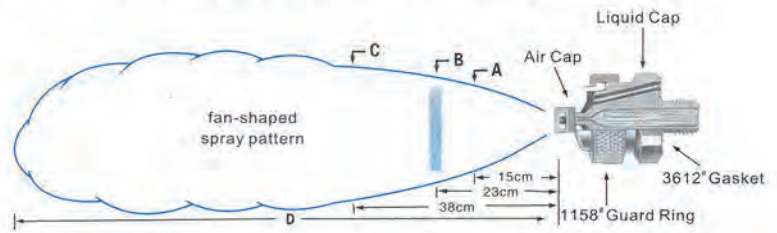

Exterior composite air cap
The exterior composite air cap, used in these spray equipments, produce fan-shaped spraying.

Remark: No. 1158 guard ring and No. 3612 gasket should be ordered separately from spray device, but they are also parts of the standard spray nozzle

fan-shaped spraying. (exterior composite)

spray device model	spray device consists of air cap and fluid cap	liquid flow (L/min)and flow (L/min)															Size									
		Water pressure (bar)															Air (bar)	Liquid (bar)	A (cm)	B (cm)	C (cm)	D (cm)				
		0.2bar		0.3bar		0.7bar		1.5bar		4bar		Air (L/min)	Water (L/h)	Air (L/min)	Water (L/h)	Air (L/min)							Water (L/h)	Air (L/min)	Water (L/h)	
SUE 15B	Liquid Cap 1650 and Air Cap 67228-45°	0.2	25.2	2.8	0.35	26.3	3.5	0.7	31.2	5.3	1.4	45.3	7.8	2.8	73.6	11.0	0.2	0.2	9	15	23	0.9				
		0.35	26.3		0.7	31.2		1.05	39.6		3.5	85.0		1.05	0.2		9	15	23	1.2						
		0.7	31.2		1.05	39.6		1.4	45.3		2.1	59.5		4.2	102		1.4	0.35	10	15	23	1.2				
		1.05	39.6		1.4	45.3		1.75	53.8		2.8	73.6		4.9	119		1.4	1.4	11.5	18	25	1.5				
		1.4	45.3		1.75	53.8		2.1	59.4		3.5	85.0		5.3	127.5		1.75	0.7	11.5	15	24	1.5				
		1.75	53.8		2.1	59.4		2.8	73.6		3.5	85.0		4.2	102		2.8	1.4	13	18	28	1.8				
2.1	59.4	2.8	73.6	3.5	85.0	4.2	102	5.6	139	4.9	2.8	15	18	24	2.4											
SUE 18B	Liquid Cap 1650 and Air Cap 67228-45°	0.35	22	2.8	0.35	22	3.5	0.4	25	5.3	0.6	28	7.8	0.7	34	11.0	0.4	0.3	20	28	33	1.2				
		0.4	25		0.4	25		0.6	28		0.7	34		0.6	0.7		23	30	40	1.8						
		0.5	27.5		0.6	28		0.7	34		0.85	40		1.1	45		0.6	1.5	28	35	46	1.8				
		0.6	28		0.7	34		0.85	40		1.1	45		1.8	62		1.1	1.5	28	33	43	2.4				
																	1.4	54	2.5	79	1.4	1.5	25	30	41	2.7
																	1.4	54	2.5	79	1.1	2.0	28	35	48	2.6
SUE 15A	Liquid Cap 2050 and Air Cap 67228-45°	0.35	26.3	4.5	0.7	31.2	5.5	1.05	39.6	8.3	1.75	53.8	12.2	3.15	82	16.6	0.35	0.2	7.5	14	22	1.0				
		0.7	31.2		1.05	39.6		1.4	45.3		2.1	59.4		3.5	85		1.4	0.2	9	15	22	1.7				
		1.05	39.6		1.4	45.3		1.75	53.8		2.8	73.6		4.2	102		1.75	0.35	10	16.5	23	1.8				
		1.4	45.3		1.75	53.8		2.1	59.4		2.8	73.6		4.2	102		1.75	1.4	13	19	29	2.1				
		1.75	53.8		2.1	59.4		2.8	73.6		3.5	85.0		4.2	102		2.1	0.7	13	18	25	1.8				
		2.1	59.4		2.8	73.6		3.5	85.0		4.2	102		5.6	119		3.5	1.4	13	22	0	2.4				
SUE 18A	Liquid Cap 2050 and Air Cap 62240-60°	0.35	22	4.5	0.35	22	5.5	0.6	28	8.3	0.7	34	12.2	1.1	45	33	0.7	0.2	13	16.5	25	1.2				
		0.6	28		0.7	34		0.7	34		1.4	54		1.4	54		1.75	0.2	13	16.5	25	1.8				
		0.7	34		1.1	45		1.4	54		2.1	71		2.1	71		2.1	0.35	13	18.0	24	1.8				
		1.1	45		1.4	54		2.1	71		2.5	79		2.5	79		2.5	1.4	14	20	32	1.8				
																	2.1	0.7	14	19	30	2.3				
																	2.5	79	4.2	1.4	14	20	36	3.0		
SUE 15	Liquid Cap 2850 and Air Cap 67228-45°	0.7	31.2	8.5	1.05	39.6	10.4	1.4	45.3	15.9	2.5	68	23	3.5	85	33	0.7	0.2	13	16.5	25	1.2				
		1.05	39.6		1.4	45.3		1.75	53.8		2.8	73.6		4.2	102		1.75	0.2	13	16.5	25	1.8				
		1.4	45.3		1.75	53.8		2.1	59.4		3.5	85		4.9	119		2.1	0.35	13	18.0	24	1.8				
		1.75	53.8		2.1	59.4		2.8	73.6		3.5	85.0		4.2	102		2.5	1.4	14	20	32	1.8				
		2.1	59.4		2.8	73.6		3.5	85		4.2	102		5.6	139		2.8	0.7	14	19	30	2.3				
		2.8	73.6		3.5	85		4.2	102		4.9	119		6.3	159		4.2	1.4	14	20	36	3.0				
SUE 18	Liquid Cap 2850 and Air Cap 62240-60°	0.4	25	8.5	0.4	25	10.4	0.4	25	15.9	0.7	34	23	1.4	54	33	0.6	0.3	35	48	61	1.8				
		0.5	27.5		0.6	28		0.6	28		0.85	40		1.8	62		0.6	0.7	35	48	63	1.5				
		0.6	28		0.65	31		0.7	34		1.1	45		2.1	71		0.7	1.5	38	48	63	1.8				
		0.7	34		0.7	34		0.85	40		1.4	54		2.5	79		1.1	1.5	41	51	66	2.1				
																	1.4	1.5	43	53	66	2.4				
																	1.8	2.0	41	51	69	2.7				

Air Atomizing Nozzle Parts

Thick wall



Using thick wall commutator instead of guard ring on spray discretteness, put it into the screw thread inlet to fixup the spray nozzle at a proper position hard. They are available for 1/8" and 1/4" nozzle, who has outer discretteness sized 3/4 inch NPT or BSPT, 1/2" nozzle who has outer discretteness sized 1 1/4 inch NPT or BSPT, and 1" nozzle who has outer discretteness sized 1 1/2 inch NPT or BSPT, including the nozzles that have cut-out and clean-out accessorial settings.

Top inlet



1/8-2 type double sprayer discretteness has two rightabout spray fittings, its air and liquid inlet is vertical to the spray line. The size of discretteness inlet is 1/8 inch NPT or BSPT(female).

Back connect



On the back, the center line of air and liquid inlet comes into the spray nozzle back, and horizontal to the spray line. The size of inlet connection are 1/4 and 1/2 inch NPT or BSPT(female).

DJ Automatic Air Atomizing Nozzle

Standard type

1/4 DJ nozzle has air and liquid screw thread with the inlet size of 1/4 inch NPT or BSPT (female), and screw thread gas driver inlet size of 1/8 inch NPT or BSPT (female). This type of nozzle is used with small-flow liquid cap.



45°

1/8 DJ spray nozzle is a compact, automatic atomizing nozzle, with a single inlet for atomizing gas and driver gas. It keeps 45 degree angle between the inlet line and spray line.



Compact type

1/8 DJ spray nozzle is a compact, automatic atomizing nozzle, with a pipeline for single gas, it's designed to be used in small area. The size of screw thread air and liquid inlet is 1/8 inch NPT or BSPT (inner).



Single gas pipeline type

With a single gas pipeline, 1/4 DJ nozzle can be used in atomizing and driving gas. It controls the pressure to drive the atomizing gas and liquid during 'on-off' period. This type of nozzle requires 2 bar gas pressure at least, and could circulate 180 times per minute.



Design features

DJ automatic air atomizing nozzle has an inner gas driver to control 'on-off', and can circulate 180 times per minute. When 'on-off' runs, only the liquid of the sprayer will be shut off. The liquid flow can be carried to the nozzle body by siphon, gravity or pressure.

All the parts of spray nozzle are made accurately at strict quality control standard, to insure running smoothly and long service lifetime. The nozzle can be made of nickel-plating brass or stainless steel. Each nozzle has a stainless steel needle valve, a stainless steel flow cap and a stainless steel spring.

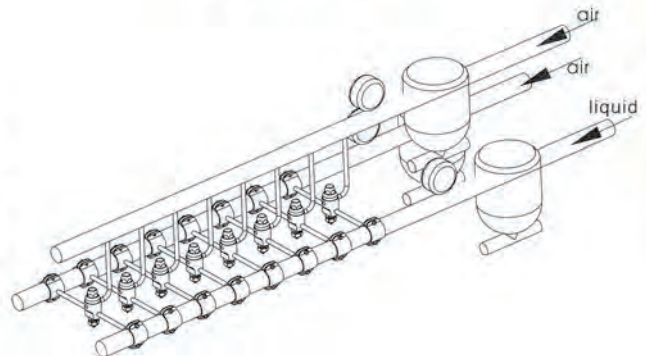
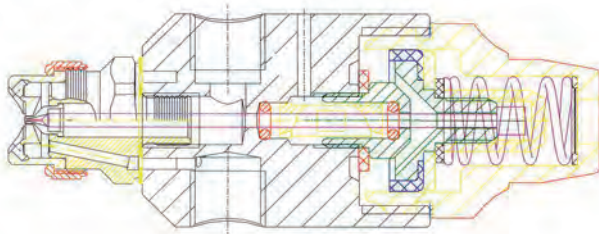

D Series Air Atomizing Nozzle

common application

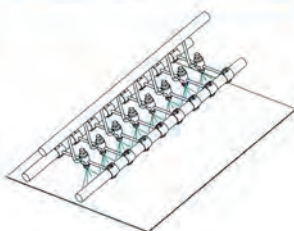

Lubricate

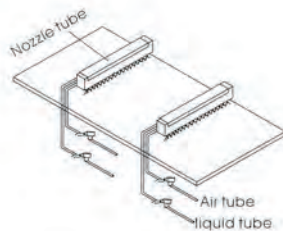

corrugating board humidify

ordering info

1/8DJ—316SS+SUCB—316SS

↓
Nozzle type Material code Nozzle device number
*Referring to D series parameter

Remark:
BRASS
SS-stainless steel
316SS-316 stainless steel

DK Automatic Fine Misting Nozzle



The nozzle is used for moistening and coating which requires accurate spraying and coating area.

common application

- Coating
- Moistening
- Viscous liquid spraying
- Circulation system

Design features

Automatic fine atomizing nozzle could independently control liquid atomizing gas pressure and fan gas pressure to adjust flow rate, droplet size, spraying distribution and coverage area accurately. Resulting from the scientific and rational design, the nozzle can spray viscous liquid ideally.

Also, the single gas atomizing pipeline can be adjusted to alter the droplet size without altering the flow rate. With an accessional entrance/exit passage, the viscous liquid circles to keep itself flowing.

Any one of these seven different spray devices is available, the flow rate is between 2.8 L/H and 179 L/H. The flow rate of atomizing gas, fan gas and liquid can be adjusted and readjusted within several seconds. So the nozzle can be adjusted to adapt various of spray application. The 'on-off' of timing controller can run automatically at the rate of 180 cycles per minute. The cylinder works only when the air pressure reaches 2.4 bar at least.

Performance data

spray device model	Liquid flow rate (L/H)		Data numbers
	0.21bar	1.4bar	
SX-CC001A	2.8	7.3	924M-001A
SX-CC002C	4.2	11.1	924M-002C
SX-CC004	8.1	21	924M-004
SX-CC004B	13.6	35	924M-004B
SX-CC005	18.4	48	924M-005
SX-CC006	38	99	924M-006
SX-CC006D	69	179	924M-006D

Remark: The data of fitting SX-CC006 is a typical example of concerned performance info supplied by each spray fitting in point.

1/8K spray nozzle	Atomizing air pressure (bar)	liquid pressure (bar)	Spray area (cm) under fan air pressure when the distance to the nozzle is designated															
			0bar			0.3bar			0.7bar			1.5bar			3bar			
spray device model SX-CC006	0.7	0.2	7.6	10.2	12.7	11.4	15.2	20	17.8	25	33	30	41	51				
		0.7											28	38	56	53	66	84
		1.5														43	56	76
	1.5	0.2	7.6	10.2	12.7	7.6	10.2	15.2	12.7	17.8	23	23	30	41	36	46	66	
		0.7				7.6	12.7	15.2	12.7	17.8	25	20	30	41	36	48	66	
		1.5													33	48	64	
2	0.2	7.6	10.2	12.7	8.9	11.4	16.5	10.2	15.2	20	15.2	20	28	30	36	53		
	0.7	6.4	8.9	12.7	7.6	10.2	14.0	10.2	15.2	22	17.8	23	38	30	41	56		
	1.5													28	38	53		
3	0.2	7.6	10.2	14.0	7.6	11.4	15.2	8.9	12.7	17.8	15.2	20	28	25	30	43		
	0.7	6.4	8.9	12.7	8.9	11.4	15.2	10.2	12.7	17.8	15.2	20	27	28	36	51		
	1.5	6.4	8.9	12.7	7.6	10.2	16.5	7.6	12.7	20	15.2	20	28	23	33	43		

When the fan air pressure is 0 bar, the spray area is circular.

Ordering info

1/8K—316SS+SX-CC006

↓ ↓ ↓
Nozzle Material Spray
type code device model

Remark:
BRASS
SS-stainless steel
316SS-316 stainless steel

DE Large flow Air Atomizing Nozzle

DE series large flow air atomizing nozzle adopts multi-atomizing, with its powerful function, is widely used for dust removing and desulfurizing in firepower plant, dust removing and environment protection in chemical plant and cement plant.

Design features

- The nozzle can be a double liquid spray nozzle, with steam or air as its second liquid
- Third class - atomizing to achieve optimum atomizing capability
- Working with high dependability even under the worst condition
- Reducing the dosage of compressed air with its high efficiency



Spraying performance

- Spray area: Hollow cone-shaped and flat fan-shaped
- Spray angle: 20 degree to 90 degree (Other angles are available according to the requirement) Flow rate: 2.0 to 80 L/M



DE spray equipment, spiral tip and size

Tube diameter	spray angle	spray nozzle number	spray angle	spray pattern	maximum droplet size mm	spiry tip number	Dimension mm				Weight (kg)	
							A	B	C	D		
1"	14	DE101	20°	narrow round angle	3.30	14	148	50.8	50.8	64	0.64	
		DE308	90°		2.69							
		DE310	60°	wide round angle	2.69							
		DE402	90°		4.22							
		DE404	60°	flat round	4.22							
	20	DE103	20°	narrow round angle	6.60		20	148	50.8	50.8		50.8
		DE307	90°		3.48							
		DE309	60°	wide round angle	3.48							
		DE401	90°		5.21							
		DE403	60°	flat round	5.21							
1 1/2"	28	DE2100	20°	narrow round angle	9.27	28	229	50.8	55.6	113	1.5	
		DE2310	90°	wide round angle	4.65							
		DE2303	60°		4.65							

Standard material: 316 stainless steel with cobalt metal wearable jacket

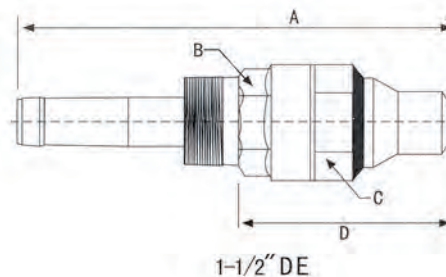
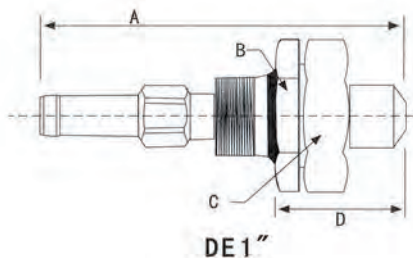

DE can be installed in all ways, as the picture shows, These applications of the device is just for individual customers. If you need more information, please contact the engineering department. We can offer a engineering manual of the DE series.

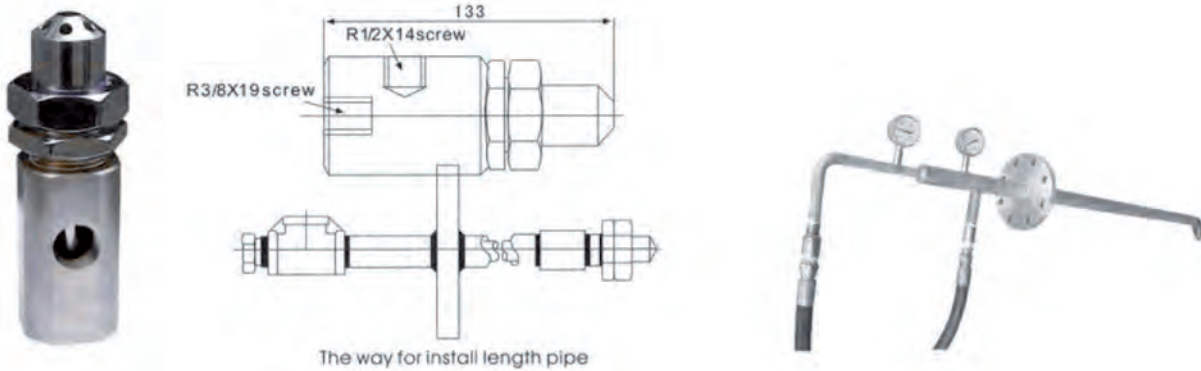

Since when the pressure of the fluid has a tiny change, the flow rate would have a big variation, CYCO kindly advice that you should control the flow rate with metering pump or other metering equipment which would be better.

narrow angle, wide angle and flat fan, 1" to 1 1/2" BSPT or NPT

BSP NPT	capacity	1.0 bar air pressure			2.0 bar air pressure			3.0 bar air pressure			4.0 bar air pressure			5.0 bar air pressure			6.0 bar air pressure			7.0 bar air pressure		
		Liquid l/min	Liquid bar	Air nm ³ /h	Liquid l/min	Liquid bar	Air nm ³ /h	Liquid l/min	Liquid bar	Air nm ³ /h	Liquid l/min	Liquid bar	Air nm ³ /h	Liquid l/min	Liquid bar	Air nm ³ /h	Liquid l/min	Liquid bar	Air nm ³ /h	Liquid l/min	Liquid bar	Air nm ³ /h
1"	14	2	0.9	25.0	2	1.9	45.0	2	2.8	60.2	2	3.7	86.3	2	4.6	105	2	5.7	137	2	6.4	149
		3	0.9	20.2	3	1.9	39.0	3	2.8	56.8	3	3.8	79.8	3	4.7	97.9	3	5.7	136	3	6.5	146
		4	1.0	17.3	4	2.0	29.1	4	2.9	50.8	4	3.8	73	4	4.8	88.9	4	5.9	123	4	6.5	134
		5			5	2.0	26.8	5	3.0	43.8	5	3.9	64.8	5	4.8	82.6	5	5.9	110	5	6.6	117
		6			6	2.1	24.4	6	3.0	41.2	6	3.9	57.9	6	4.9	78.3	6	6.1	100	6	6.7	112
		7			7	2.1	21.9	7	3.0	38.5	7	4.0	53.2	7	5.0	69.9	7	6.2	94.9	7	6.8	107
	8						8	3.1	35.4	8	4.1	49.9	8	5.0	66.7	8	6.2	88.9	8	6.9	100	
	9									9	4.1	47.0	9	5.1	64.1	9	6.3	79.8	9	7.0	93.2	
	10									10	4.2	45.3	10	5.1	60.5	10	6.4	75.2	10	7.1	86.0	
	12									12	4.4	39.3	12	5.3	53.2	11	6.6	69.6	11	7.2	83.6	
	12															12	6.6	68.4	12	7.3	80.3	
	20	4	0.2	34.9	4	1.5	64.4	4	2.4	91.7	4	3.2	117	4	4.0	140	4	4.8	161	4	5.6	180
8		0.8	24.3	8	1.7	45.9	8	2.6	68.1	8	3.5	91.0	8	4.4	114	8	5.2	139	8	6.0	163	
11				11	1.9	35.8	11	2.9	56.3	11	3.8	78.0	11	4.6	101	11	5.3	125	11	6.0	151	
15				15	2.1	26.8	15	3.0	45.8	15	3.9	65.2	15	4.8	85.2	15	5.6	105	15	6.4	126	
19				19	2.2	23.6	19	3.1	39.0	19	4.1	55.9	19	5.0	74.4	19	5.8	94.3	19	6.7	116	
23				23	2.4	21.8	23	3.3	36.7	23	4.2	51.6	23	5.1	67.2	23	5.9	82.8	23	6.8	96.7	
26							26	3.5	31.8	26	4.4	46.9	26	5.2	61.6	26	6.1	76.1	26	6.9	90.2	
30										30	4.5	42.9	30	5.4	55.6	30	6.2	70.4	30	7.1	87.4	
34										34	4.7	37.0	34	5.6	50.6	34	6.5	62.7	34	7.3	73.2	
38										38	5.0	32.4	38	5.9	47.2	38	6.7	57.8	38	7.5	64.2	
28	40						40	3.1	76.3	40	4.0	107	40	5.0	142	40	6.0	183	40	7.0	229	
	45						45	3.2	69.0	45	4.2	97.4	45	5.2	130	45	6.2	167	45	7.3	208	
	50						50	3.3	61.8	50	4.2	88.4	50	5.2	118	50	6.3	152	50	7.3	189	
	55						55	3.4	55.5	55	4.3	80.7	55	5.3	109	55	6.3	141	55	7.4	175	
	60						60	3.5	49.1	60	4.4	73.2	60	5.4	100	60	6.4	130	60	7.5	162	
	65						65	3.6	43.1	65	4.6	66.3	65	5.6	92.3	65	6.6	121	65	7.6	152	
	70						70	3.8	37.5	70	4.8	60.2	70	5.8	85.8	70	6.8	114	70	7.9	145	
	75						75	4.0	32.1	75	5.0	54.6	75	6.1	80.2	75	7.1	109	75	8.2	141	
80						80	4.2	27.1	80	5.2	49.8	80	6.2	76.0	80	7.2	106	80	8.2	139		

standard material :316 stainless steel, co alloy 6 weared sheath. Other material please find the stock list as reference. Please clearly indicate: the pipe diameter, way of connection, nozzle type, spray angle and material.

Hollow Cone, Full Cone Spiral Nozzle

Design features

SPJT Nozzle is hollow/full cone with spraying angle from 60°C to 170°C. Under 3 Bar pressure, the flowing rate of liquid is 5.5-4140 L/min.

It has an expedite flow channel design, which can decrease liquid barrier for max. capacity with certain size. Rotary spray nozzle can be installed or updated in lots of pipe system.

NPT/BSPT (male) Thread are provided. The common 1/4"-2" nozzles are made of brass, SS316, Teflon or PVC. Other selective materials can be used for special application.



Spraying shapes



Full cone



Hollow cone

common application

- Exhaust gas filtration
- Gas cooling
- Washing and rinsing
- Fireproofing and fire extinguishment

Performance data

pipe connection NPT or BSPT (out)	Spray angle (0.7bar)					Capacity Size	orifice size (mm)	Diameter of nozzle without block(mm)	Capacity (L/min)				
	60°	90°	120°	150°	170°				0.7bar	1.5bar	3bar	7bar	25bar**
1/4	●	●	●			07	2.4	2.4	2.6	3.9	5.5	8.4	16
	●	●	●	●	●	13	3.2	3.2	4.9	7.3	10.3	15.7	30
	●	●	●	●	●	20	4.0	3.2	7.6	11.2	15.8	24	46
3/8	●					07	2.4	2.4	2.6	3.9	5.5	8.4	16
	●					13	3.2	3.2	4.9	7.3	10.3	15.7	30
	●					20	4.0	3.2	7.6	11.2	15.8	24	46
	●	●				30	4.8	3.2	11.4	16.7	24	36	68
	●	●	●			40	5.6	3.2	15.1	22	32	48	91
	●	●	●	●	●	53	6.4	3.2	20	30	42	64	121
1/2	●	●	●	●	●	82	7.9	3.2	31	46	65	99	187
	●	●	●	●	●	120	9.5	4.8	45	67	95	145	270
3/4	●	●	●	●	●	164	11.1	4.8	62	92	129	198	370
	●	●	●	●	●	210	12.7	4.8	80	117	166	255	480
1	●	●	●	●	●	340	15.9	6.4	130	190	270	410	775
	●	●	●	●	●	470	19.1	6.4	179	260	370	565	1070
1-1/2	●	●	●	●	●	640	22.2	7.9	245	355	505	770	1460
	●	●	●	●	●	820	25.4	7.9	310	455	645	990	1870
	●	●	●	●	●	960	28.6	7.9	365	535	755	1160	2190
2	●	●	●	●	●	1400	34.9	11.1	535	780	1105	1690	3190
	●	●	●	●	●	1780	38.1	11.1	680	995	1405	2150	4060
3	●	●	●			2560	44.5	14.3	980	1430	2020	3090	5830
	●	●	●			3360	50.8	14.3	1280	1880	2650	4050	7660
4	●	●	●			5250	63.5	15.9	2000	2930	4140	6330	11960

** Brass or SS316 for higher pressure.

ordering info

1/4 **SPJT** — **SS** **120** **07**

↓ ↓ ↓ ↓ ↓

Inlet size Nozzle type Material code Spray angle Capacity size

Remark:
BRASS
SS-stainless steel
316SS-316 stainless steel
TEF-TEFLON Poly Tetra Fluoro Ethylene
PP-Poly propylene

SIZE

Nozzle Inlet Conn.	Nozzle length (mm)	Spray angle
1/4	53.9	60°, 150° and 170°
1/4	47.6	90° and 120°
3/8	60.3	60°, 150° and 170°
3/8	47.6	90° and 120°
1/2	79.4	60°, 150° and 170°
1/2	63.5	90° and 120°
3/4	87.3	60°, 150° and 170°
3/4	69.9	90° and 120°
1	116	60°, 150° and 170°
1	92.1	90° and 120°
1 1/2	171	60°, 150° and 170°
1 1/2	111	90° and 120°
2	175	60° and 170°
3	302	60°
3	203	90° and 120°
4	229	60°, 90° and 120°

accessories



Adjustable connection

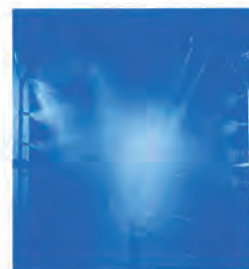

Flanged Silicone Carbide Spray Nozzle

Design features

The flanging spray nozzle, with a hollow cone spray pattern, fixes on the polyester flange, having a cuspidal structure which is made of carborundum. It also can be made of an alternative material. The flange connection size of this nozzle have 2", 3" and 4". Under pressure of 0.7 bar, the flow rate can spread from 535l/min to 2000l/min. Spray angle: 2" is 60° to 180°, 3" and 4" is 60° to 120°

These high flow rate spray nozzles take a great effect in pollution control, cooling and air infalting. Because of the big and fluent flow channel, it is seldom clogged.

It also have a precise blade, which makes the partical well distributed and gets the best coverage area. The flanging spray nozzle can OEM accoding to customers requirement as several kinds of material for are available.

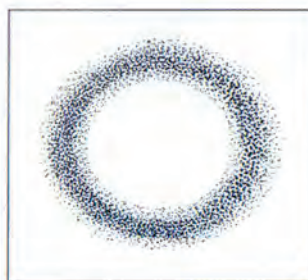

SPJT



common application

- Flue gas desulfurizing
- Dust removing
- Gas cooling

Performance data

Nozzle Inlet Conn.	Spray angle (0.7bar)				Capacity Size	Rated Orifice Dia. (mm)	Diameter of nozzle without block(mm)	Capacity (L/min)				
	60°	90°	120°	180°				0.7bar	1.5bar	3bar	7bar	25bar
2 inch Flange	●	●	●	●	1400	34.9	11.1	535	780	1105	1690	3190
	●	●	●	●	1780	38.1	11.1	680	995	1405	2150	4060
3 inch Flange	●	●	●		2560	44.5	14.3	980	1430	2020	3090	5830
	●	●	●		3360	50.8	14.3	1280	1880	2650	4050	7660
4 inch Flange	●	●	●		5250	63.5	15.9	2000	2930	4140	6330	11960

ordering info

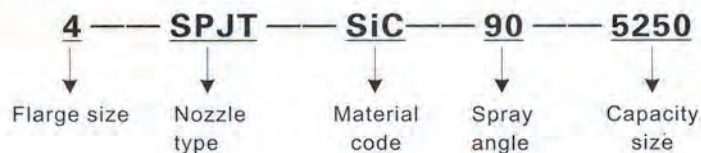

AAZ Fine Atomized Nozzle

AAZ-W



Strainer built-in,
wide spray angle
1/4 inch NPT
or BSPT (male)

AAZ-N



Strainer built-in,
1/4 inch NPT
or BSPT (female)

AAZ-M



catamaran design
1/4 inch NPT
or BSPT (male)

Design features

Fine atomizing nozzle utilizes the fluid pressure to produce the extremely fine particle, and the spray pattern is a uniform hollow cone, which can make the spray like fogs.

All the parts are precisely composed. The inlay of orifice, the taper core and the strainer are easy to dismantled for excaming and washing.

All the above nozzles have strainers.

Common application

- Moistening in air control chamber
- Cooling for gas and metal
- Liquid medicine spraying
- humidity conditioning
- evaporative cooling

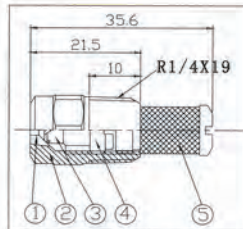

1.Orifice 2.Body 3.Cyclone Core 4.Plug 5.strainer mesh

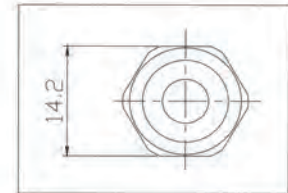

Performance data

AAZ-W	AAZ-N	AAZ-M	Rated Orifice Dia. (mm)	Core Type	Capacity(L/min)										Spray angle		
					2bar	5bar	10bar	15bar	20bar	30bar	40bar	50bar	70bar	3bar	6bar	20bar	
1/4AAZ-W0.60	1/4AAZ-N0.60	1/4AAZ-M0.60	0.41	206			4.3	5.3	6.1	7.5	8.6	9.7	11.4		35°	65°	
1/4AAZ-W1	1/4AAZ-N1	1/4AAZ-M1	0.51	210		5.1	7.2	8.8	10.2	12.5	14.4	16.1	19.1	45°	62°	72°	
1/4AAZ-W1.5	1/4AAZ-N1.5	1/4AAZ-M1.5	0.51	216	4.8	7.6	10.8	13.2	15.3	18.7	22	24	29	65°	70°	72°	
1/4AAZ-W2	1/4AAZ-N2	1/4AAZ-M2	0.71	216	6.4	10.2	14.4	17.7	20	25	29	32	38	70°	75°	77°	
1/4AAZ-W3	1/4AAZ-N3	1/4AAZ-M3	0.71	220	9.7	15.3	22	26	31	37	43	48	57	65°	70°	73°	
1/4AAZ-W4	1/4AAZ-N4	1/4AAZ-M4	1.1	220	12.9	20	29	35	41	50	58	64	76	72°	81°	84°	
1/4AAZ-W6	1/4AAZ-N6	1/4AAZ-M6	1.1	225	19.3	31	43	53	61	75	86	97	114	73°	79°	81°	
1/4AAZ-W8	1/4AAZ-N8	1/4AAZ-M8	1.5	225	26	41	58	71	82	100	115	129	153	85°	89°	91°	
1/4AAZ-W10	1/4AAZ-N10	1/4AAZ-M10	1.6	420	32	51	72	88	102	125	144	161	191	82°	84°	86°	
1/4AAZ-W12	1/4AAZ-N12	1/4AAZ-M12	1.9	420	39	61	86	106	122	150	173	193	230	78°	82°	85°	
1/4AAZ-W14	1/4AAZ-N14	1/4AAZ-M14	1.9	421	45	71	101	124	143	175	200	225	265	85°	88°	90°	
1/4AAZ-W18	1/4AAZ-N18	1/4AAZ-M18	1.9	422	58	92	130	159	183	225	260	290	345	81°	84°	86°	
1/4AAZ-W22	1/4AAZ-N22	1/4AAZ-M22	1.9	625	71	112	159	194	225	275	320	355	420	70°	72°	75°	
1/4AAZ-W26	1/4AAZ-N26	1/4AAZ-M26	2.2	625	84	133	187	230	265	325	375	420	495	73°	74°	77°	

ordering info

1/4 — AAZ-W — 206

↓ ↓ ↓
Inlet size Nozzle type Core No.

FD Anti-drop Misting Nozzle

Nozzle body is made of brass, with stainless steel nozzle core and stainless steel flow leading vane(include a leakproof device) inside. Under hydraulic pressure of 70kg to 120kg, it flows with high speed and forms centrifugal volution in flow leading vane. Then it sprays tiny hollow spraying drop of around 50um with Teflon mesh, which can be widely applied in moisturization and man-made mist. It introduced American driller for drill of spray hole, with hole diameter of 0.1mm to 0.15mm. Compared with air moisturization, it cuts cost by ten times.



FD Series

FD Series	
Structure	It is composed of brass body, SS paneling, O-shaped sealing ring and leakproof globe.
Material	Brass or SS303

Performance data

Brass nozzle	Orifice	Operation pressure	Spray volume
FD 1	0.15mm	20~70kg/cm	20~46cc/min
FD 2	0.20mm		49~89 cc/min
FD 3	0.30mm		80~145 cc/min
FD 4	0.40mm		95~178 cc/min
FD 5	0.50mm		130~243cc/min

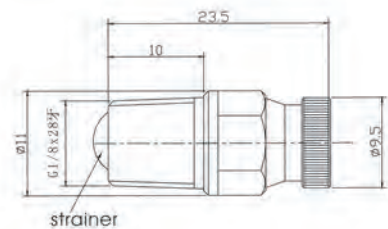
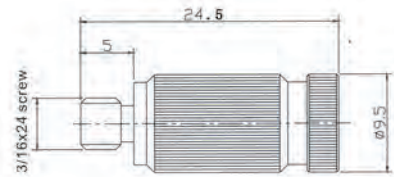

common application

- Wetting & rust removal
- Humidify for space
- Chemical treatment
- Chemical agent spraying
- Liquid coating
- Humidify for tobacco leaf
- Pill coating
- Evaporative cooling for flue gas
- Disinfection & sterilization
- Parts cooling
- Fruit wax injection
- Ceramic tile glazing
- Humidify for factory
- Salt fog test
- Artificial fog
- Humidify for other place

ordering info

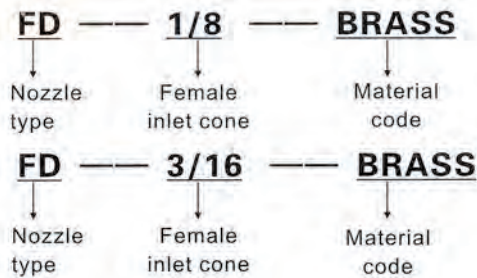

FE Plastic Fine Misting Nozzle

Design features

Material: PP

Features: All the parts are precisely manufactured, the spray particles is 20-40micro

Spray angle: 80-90 degrees,

Water output: 1.6-3.4/hr,

Water system pressure: 3-14kg

The coverage area of each spray nozzle is 3-4 square meter.

Cooling capacity: 5-10°C

Advantages: It features a strainer inside which can guarantee no-clogging being blocked and more durable. It also has the function of anti-drip that the nozzle will not drip when the pressure system is closed.



Common application

- Cooling and humidifying in the factory and greenhouse
- Industry: Humidifying in textile mill building, cigarette factory building, electronic factory building, paper mill building, printing house building, auto coating plant building, wood/ furniture processing factory building, explosive plant building and so on. Cooling in power plant building and steelworks building. Humidifying and cooling in brewing and food service industry.
- Agriculture: Humidifying and cooling in refrigeratory, greenhouse, livestock production, plant nursery, edible fungi cultivation, fruit-vegetable cultivation, electrostatic prevention, disinfection, haze injury control, dust abatement.
- Landscape spraying: The fog spraying out from the nozzle like a cloud, floating with wind in the air, sometimes visible, and sometimes fading away, very beautiful. Meanwhile, there are a lot of negative ion in the spray particles, which can increase the oxygen content in the air, making a most friendly-environmental place to live.

Spray applications



Adjustable Clamp nozzle



Design features

Adjusting Ball-Type Nozzle have got two types: clamp connection type(26988/27988 series) and thread connection type(155series). The clamp connection type nozzle is positioned on the pipe with spring clamp while the thread connection type nozzle is positioned by the way of thread connection.

Adjusting Ball-Type Nozzle provides hollow cone spray pattern, solid cone spray pattern and flat fan spray pattern. It meets various needs by directly connecting ball spray tip or by indirectly connecting spray tip with threaded ball or quick dismantling ball. It permits accurate alignment and convenient nozzle positioning without disturbing pipe connection.

Adjusting Ball-Type Nozzle allows for quick and easy tip replacement. Spray tips can be removed without the use of tools, removing the existing spray tip by hand and installing the new tip.

Clamp Nozzle Specification

Type	Clamp Size (inch)	Clamp Outer Dia. (mm)	Pipe Orifice Dia. (Mm)
26988	1	32-35	14
	1-1/4	38-43	16
	1-1/2	44-51	18
	2	54-60	20
27988	1/2	21	14
	3/4	27	
	2	54-60	

Spray Pattern

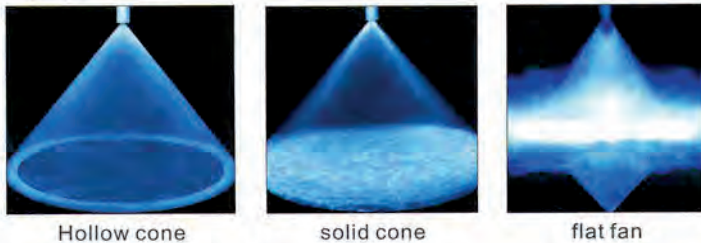

Hollow cone

solid cone

flat fan

Threaded Nozzle Specification

Type	Connection Thread Size (inch)
155	1/8
	1/4
	3/8
	1/2

common application

- Metal Cleaning
- Degreasing and phosphatizing in surface treatment
- Other Low Pressure Applications

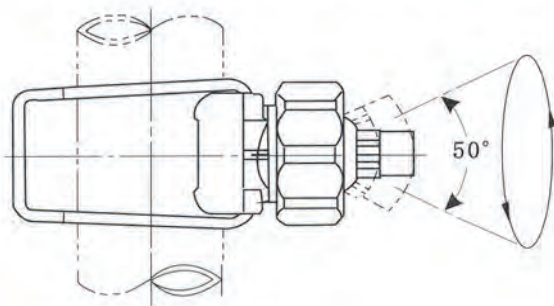

material characteristics

Parts	Materials
Cap Spray Tip Base	Fiber-glass-reinforced PP(25%fiber) with maximum temperature of 82°C good performance on chemical resistance
	carbon fiber-glass-reinforced PP(40%fiber) with maximum temperature of 120°C good performance on chemical resistance and abrasion resistance
Spring Clamp	Spring Clamp/hardened 304 stainless steel
Gasket	butadiene acrylonitrile rubber
	fluorine rubber

Performance data

Hollow Cone Spray Tip



nozzle type	Capacity liters per minute							Spray angle		
	0.3bar	0.7bar	1bar	1.5bar	2bar	3bar	4bar	0.5bar	1.5bar	4bar
AT15-30.1	6.2	8.8	10.4	12.6	14.5	17.6	20.2	46°	49°	51°
AT25-30.1	7.5	10.7	12.7	15.4	17.6	21.4	24.6	45°	47°	50°
AT55-50.1	13.5	19.0	22.7	27.8	32.0	39.2	45.2	38°	46°	48°
AT55-50.3	13.5	19.0	22.7	27.6	31.8	38.7	44.4	75°	45°	76°

G Series Adjustable Clamp Nozzle

Flat Fan Spray Tip



Spray Tip Type (spray angle at 3 bar)						Capacity(L/min)							
15°	25°	40°	50°	65°	80°	0.3bar	0.7bar	1bar	1.5bar	2bar	3bar	4bar	
				CT6510	CT8010	1.2	1.9	2.3	2.8	3.2	3.9	4.6	
		CT4020	CT5020	CT6520		2.5	3.8	4.6	5.6	6.5	7.9	9.1	
	CT2530	CT4030	CT5030	CT6530		3.7	5.7	6.8	8.4	9.7	11.8	13.7	
		CT4040	CT5040	CT6540	CT8040	5.0	7.6	9.1	11.2	12.9	15.8	18.2	
CT550		CT4050	CT5050	CT6550		6.2	9.5	11.4	14.0	16.1	19.7	23	
	CT2560	CT4060	CT5060	CT6560	CT8060	7.5	11.4	13.7	16.7	19.3	24	27	
CT1570	CT1570	CT4070	CT5070	CT6570	CT8070	8.7	13.3	16.0	19.5	23	28	32	
CT15100	CT15100	CT40100	CT50100	CT65100	CT80100	12.5	19.1	23	28	32	39	46	

Full Cone Spray Tip



nozzle type	Capacity(L/min)								Spray angle		
	0.3bar	0.7bar	1bar	1.5bar	2bar	3bar	4bar	0.5bar	1.5bar	4bar	
BT6	1.6	2.3	2.6	3.2	3.7	4.5	5.1	69°	74°	68°	
BT12.5	3.4	4.8	5.4	6.8	7.7	9.3	10.6	69°	74°	68°	
BT25	6.7	9.5	10.9	13.5	15.4	18.6	21	64°	67°	63°	
BT50	13.5	19.1	21.9	27	31	37	42	91°	94°	88°	

Quick Dismantling Ball Specification

Quick Dismantling Ball Type	Connection Object
B L Q	Quick Dismantling Object



Threaded Ball Specification

Threaded Ball Type	Thread Size inch
BL1	1/8
BL2	1/4
BL3	3/8



Flat Fan Quick Dismantling Spray Tip



Spray Tip Type (spray angle at 3 bar)					Capacity(L/min)								
50°	65°	80°	95°	110°	0.3bar	1bar	2bar	3bar	4bar	5bar	6bar	7bar	14bar
QC5001	QC6501	QC8001	QC9501	QC11001	0.12	0.23	0.32	0.39	0.46	0.51	0.56	0.60	0.85
QC5002	QC6502	QC8002	QC9502	QC11002	0.25	0.45	0.64	0.79	0.91	1.0	1.1	1.2	1.7
QC5003	QC6503	QC8003	QC9503	QC11003	0.37	0.69	0.97	1.2	1.4	1.5	1.7	1.8	2.6
QC5004	QC6504	QC8004	QC9504	QC11004	0.5	0.92	1.3	1.6	1.8	2.0	2.2	2.4	3.4
QC5005	QC6505	QC8005	QC9505	QC11005	0.62	1.1	1.6	2.0	2.3	2.5	2.8	3.0	4.3
QC5006	QC6506	QC8006	QC9506	QC11006	0.75	1.3	1.9	2.4	2.7	3.1	3.3	3.6	5.1
QC5008	QC6508	QC8008	QC9508	QC11008	1.0	1.8	2.6	3.2	3.6	4.1	4.5	4.8	6.8
QC5010	QC6510	QC8010	QC9510	QC11010	1.2	2.3	3.2	3.9	4.6	5.1	5.6	6.0	8.5
QC5015	QC6515	QC8015	QC9515	QC11015	1.9	3.4	4.8	5.9	6.8	7.6	8.4	9.0	12.8
QC5020	QC6520	QC8020	QC9520	QC11020	2.5	4.6	6.5	7.9	9.1	10.2	11.2	12.1	17.1
QC5030	QC6530	QC8030	QC9530	QC11030	3.7	6.8	9.7	11.8	13.7	15.3	16.7	18.1	26

Full Cone Quick Dismantling Spray Tip



nozzle type	Capacity(L/min)										Spray angle		
	0.5bar	0.7bar	1.5bar	2bar	3bar	4bar	5bar	6bar	7bar	10bar	0.5bar	1.5bar	6bar
QB1	0.25	0.38	0.54	0.62	0.74	0.85	0.94	1.0	1.1	1.3	-	58°	53°
QB2	0.65	0.76	1.0	1.2	1.5	1.7	1.9	2.0	2.2	2.6	43°	50°	46°
QB3	0.98	1.1	1.6	1.9	2.2	2.5	2.8	3.1	3.3	3.9	52°	65°	59°
QB3.5	1.1	1.3	1.9	2.2	2.6	3.0	3.3	3.6	3.9	4.5	43°	50°	46°
QB5	1.6	1.9	2.7	3.1	3.7	4.2	4.7	5.1	5.5	6.5	52°	65°	59°
QB6.5	2.1	2.5	3.5	4.0	4.8	5.5	6.1	6.7	7.1	8.4	45°	50°	46°
QB10	3.3	3.8	5.4	6.2	7.4	8.5	9.4	10.2	11.0	13.0	58°	67°	61°

ordering info

26988 — 1 — D14 — PP + CT 6530 — PP

Nozzle type clamp size Pipe orifice Dia. Material code Spray Tip Type Material code

155 — 3/8 — PP — BLQ — PP + QC 6505 — PP

Nozzle type Inlet size Material code Quick Dismantling Ball type Material code Spray Tip Type Material code

26988RS Adjustable Global spray Nozzle

Available spraying modes:hollow cone,full cone and flat fan.Available spray tip:connecting type and whole type.The body can be made of Brass or SS,while the screw thread can be made of PVDF,Brass,SS or Titanium.

The spray tip can be quickly oriented and direct disassembled without other tools.

Available sizes of water pipe for body listed as follows:



26988RS Series

Model	Clamp size (inch)	Outer Dia. of pipe(mm)	Orifice of pipe(mm)
26988RS	1	32-35	14
	1-1/4	38-43	16
	1/1/2	44-51	18
	2	54-60	20

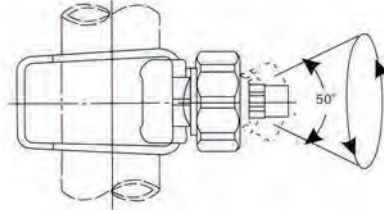

Flat Fan Spray Tip

Spray Tip Type (spray angle at 3 bar)						Capacity (L/min)						
15°	25°	40°	50°	65°	80°	0.3bar	0.7bar	1bar	1.5bar	2bar	3bar	4bar
				CT6510	CT8010	1.2	1.9	2.3	2.8	3.2	3.9	4.6
		CT4020	CT5020	CT6520		2.5	3.8	4.6	5.6	6.5	7.9	9.1
	CT2530	CT4030	CT5030	CT6530		3.7	5.7	6.8	8.4	9.7	11.8	13.7
		CT4040	CT5040	CT5040	CT8040	5.0	7.6	9.1	11.2	12.9	15.8	18.2
CT550		CT4050	CT5050	CT6550		6.2	9.5	11.4	14	16.1	19.7	23
	CT2560	CT4060	CT5060	CT6560	CT8060	7.5	11.4	13.7	16.7	19.3	24	27
CT1570	CT1570	CT4070	CT5070	CT6570	CT8070	8.7	13.3	16.0	19.5	23	28	32
CT15100	CT15100	CT40100	CT50100	CT65100	CT80100	12.5	19.1	23	28	32	39	46

Hollow Cone Spray Tip

nozzle type	Capacity (L/min)							Spray angle		
	0.3bar	0.7bar	1bar	1.5bar	2bar	3bar	4bar	0.5bar	1.5bar	4bar
AT15-30.1	6.2	8.8	10.4	12.6	14.5	17.6	20.2	46°	49°	51°
AT25-30.1	7.5	10.7	12.7	15.4	17.6	21.4	24.6	45°	47°	50°
AT55-50.1	13.5	19.0	22.7	27.8	32.0	39.2	45.2	38°	46°	48°
AT55-50.3	13.5	19.0	22.7	27.6	31.8	38.7	44.4	75°	75°	76°

Full Cone Spray Tip

nozzle type	Capacity (L/min)							Spray angle		
	0.35bar	0.7bar	1bar	1.5bar	2bar	3bar	4bar	0.5bar	1.5bar	4bar
BT6	1.6	2.3	2.6	3.2	3.7	4.5	5.1	69°	74°	68°
BT12.5	3.4	4.8	5.4	6.8	7.7	9.3	10.6	69°	74°	68°
BT25	6.7	9.5	10.9	13.5	15.4	18.6	21	64°	67°	63°
BT50	13.5	19.1	21.9	27	31	37	42	91°	94°	88°

ordering info

26988RS — **1-1/4** — **D14** — **SS** + **B12** — **SS** + **CC1/4** — **SS 6505**

↓ ↓ ↓ ↓ ↓ ↓ ↓

Nozzle series Clamp size Pipe orifice Dia. Material code Threaded Ball Material code Nozzle type

G Series Adjustable Clamp Nozzle

PVDF nozzle

Design features

High purity

PVDF nozzle is made of PVDF, which is a sort of natural & pure material without pigment. It can keep high clarification in processing and meet the requirements high.

Heat Resistance

Max temperature of PVDF nozzle is 148°C with 7kg press; Suitable for PCB printing course, including development, plating, etching and film removal.

Anticorrosive

PVDF has good anti corrosion; The PVDF nozzle can be widely used in spraying of chlorid, acid, alkali and amidocyanogen with good antiaging performance.



Wide scope and long life

Available sizes of PVDF nozzle: 1/8", 1/4" & 3/8" Three available size for common pipes with different spraying capacity and angle to meet various requirements. As high hardness material, it is wearable and impact resistant with high-intensity.

Performance Data



BB-KY Nozzle



Full Cone

Inlet Joint	Capacity	Capacity (L/min)							Spray angle		
		0.7Bar	1.5Bar	2Bar	3Bar	4Bar	6Bar	7Bar	0.7Bar	1.5Bar	6Bar
1/8	1.3	0.5	0.7	0.8	0.97	1.1	1.3	1.4	52°	65°	59°
	3	1.1	1.6	1.9	2.2	2.5	3.1	3.3	52°	65°	59°
	4	1.5	2.2	2.5	3.0	3.4	4.1	4.4	52°	65°	59°
	6	2.3	3.2	3.7	4.5	5.1	6.1	6.6	67°	75°	82°
1/4	6	2.3	3.2	3.7	4.5	5.1	6.1	6.6	67°	75°	82°
	8	3.0	4.3	4.9	6.0	6.8	8.2	8.8	58°	70°	64°
3/8	6	2.3	3.2	3.7	4.5	5.1	6.1	6.6	67°	75°	82°
	8	3.0	4.3	4.9	6.0	6.8	8.2	8.8	58°	70°	64°
	10	3.8	5.4	6.2	7.4	8.5	10.2	11.0	58°	70°	64°

CC-KY Series



Flat Fan

Inlet Joint	Spray Angle				Capacity (L/min)								
	65°	80°	95°	120°	0.3Bar	1Bar	2Bar	3Bar	4Bar	5Bar	6Bar	7Bar	10Bar
1/8	6502	8002	9502	12002	0.25	0.46	0.64	0.79	0.91	1.0	1.1	1.2	1.4
	6503	8003	9503	12003	0.37	0.68	0.97	1.2	1.4	1.5	1.7	1.8	2.2
	6504	8004	9504	12004	0.50	0.91	1.3	1.6	1.8	2.0	2.2	2.4	2.9
	6505	8005	9505	12005	0.62	1.1	1.6	2.0	2.3	2.5	2.8	3.0	3.6
	6506	8006	9506	12006	0.75	1.4	1.9	2.4	2.7	3.1	3.3	3.6	4.3
	6508	8008	9508	12008	1.0	1.8	2.6	3.2	3.6	4.1	4.5	4.8	5.8
1/4	6510	8010	9510	12010	1.2	2.3	3.2	3.9	4.6	5.1	5.6	6.0	7.2
	6515	8015	9515	12015	1.9	3.4	4.8	5.9	6.8	7.6	8.4	9.0	10.8
	6520	8020	9520	12020	2.5	4.6	6.5	7.9	9.1	10.2	11.2	12.1	14.4
3/8	6530	8030	9530	12030	3.7	6.8	9.7	11.8	13.7	15.3	16.7	18.1	22

Ordering Information

BB-KY	—	1/8	—	4	CC-KY	—	1/4	—	6510
↓		↓		↓	↓		↓		↓
Nozzle		Inlet		Flow	Nozzle		Inlet		Flow
eries		connection		rate	eries		connection		rate
				code					code

Application

- PCB
- Wash & Rinse
- Dust Removing
- Quenching & Cooling
- Gas Filtration
- Oxidization, Froth
- Extinguishment & aeration

J Series Of Plastic Clamp Nozzle



KC-01
1"clamp



KC-02
1/2"Lamp



KC-03
3/4"lamp



KC-04
3/4"lamp



JK Series

It is installed in the pipe size of 1/2"3/4"or 1"with the size of orifice is 3/8".The pressure is 320 bar for accessories.

Part No	Folder tube
JK7421-1/2-NYB	1/2"Lamp
JK7421-3/4-NYB	3/4"lamp
JK7421-1-NYB	1"clamp



The standard material for gasket is PPwhile Viton is available. Gaskets fixed in spray caps are instaled on spray tips.

The interchangeable spray tips whose operating pressure limit is 20 bar, are made from PP/SS/BRASS.

Grooves are designed in spray caps to fix the lugs. The spray caps are made from nylon.

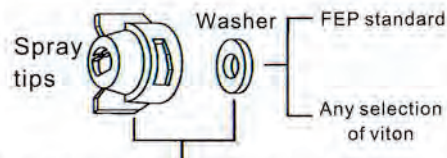

Quick removeable e tips and gasket

Spray tips tips are replaced used	Quick removeable e tips	Part No	
		Spray tips	Quick removeable e tips and gasket
		CP25611-NY	25612-NYR
		CP25609-NY	25610-NYR

Metal clamp connector

Design features

Connector provides quick and economical method for the nozzle and other parts installation at piping. Only to drill a hole of fitting diameter, along the pipeline to slip the connector and screw the bolt tightly, lock up it at proper place. This special design not only avoids the jointing of screw thread, but also reduces the cost. It also can use to install the nozzle in the sustain pipe which without screw thread.

Connector body was made of steel bar , the joint size of exit can be choosing. If it must uninstall the nozzle after the connector installation, then this design prevents the connector running in the clip button.

This connector entrance can embed the pipeline, it avoid deposit enter into it and make the block reduce minimum. DingQing rubber tight fix the cushions that can make most material erode, it provides a well airtproof condition.

Performance Data

The model No. are based on the max. size and heaviest weight



Ordering Information

7521 — B — 1 X 1/4

Connector Model Material code Clamp size Outlet connection NPT or BSPT (Outside)

Folder deduction connectors	Clamp size		Outlet connection NPT or BSPT			Common material			Max. Pressure (bar)	Max. liquid (L/MIN)	Size				Net weight (kg)
	Pipe size (inch)	Outer pipe dia.(mm)	A	B	C	A	B	C			A (mm)	B Pipe orifice dia.	C Body inlet dia.	D (mm)	
7521	1/2	20-22	1/8	1/4		●	●	●	17	11	48	7.1mm	4.8mm	17.5	0.06
	3/4	25-27	1/8	1/4		●	●	●							
	1	32-35	1/8	1/4		●	●	●							
8370	1 1/4	39-43	1/4	3/8	1/2	●	●	●	9	45	70	17.5mm	11.1 or 14.3mm	20	0.17
	1 1/2	44-51	1/4	3/8	1/2	●	●	●							
	2	54-60	1/4	3/8	1/2	●	●	●							
						●	●	●							

A standard for galvanize metal clamp & bolt used in brass connector ; B standard for SS ; C standard for galvanize metal clamp & bolt used in SS connector

K1 Air Absorption Flat Fan Spray Nozzle

Features

- Air or steam flat fan spraying
 - The shortest continuing distance for the effective spray angle, which is different from liquid
 - Compressed air: cleaning, dust-removing, drying, air curtain
 - Steam: humidifying, temperature-adjusting, humidity-adjusting and so on.
- standard pressure 3 bar

Major application

- Compressed air: cleaning, dust-removing, drying, air curtain.
- Steam: humidifying, temperature-adjusting, humidity-adjusting and so on.

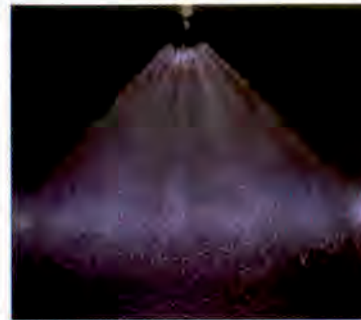

K1 Series

K1 Series	
Construction	consists of jet tip, cap and joint parts, only the cap of the nozzle tip can be changed, the joint parts can be changed with the standard flat fan spray nozzle (for liquid)
Material	brass, Ss303, ss316 and others.

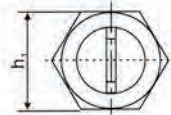
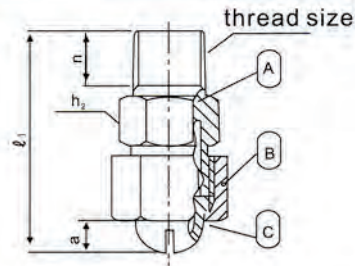

A. combined base B. Cap C spray tip

(Note: It may look a little different because of different model material.)

Series	thread size	Size (mm)					Weight (gr.)	
		l ₁	h ₁	h ₂	a	n	BRASS	S303
K1	1/4	43	19	17	6.5	10.5	47	44
	3/8	48.5	23	21	9.5	11	78	73

Performance Data

Nozzle type	slot width	Air Capacity liters per minute				Steam flow rate				The coverage of nozzle for distance is 150mm	
		1 Bar	2 Bar	4 Bar	7 Bar	1 Bar	2 Bar	4 Bar	7 Bar	1 Bar	4 Bar
		L	0.20	21	38	65	102	0.75	1.4	2.3	3.7
P	0.33	41	60	99	153	1.5	2.1	3.6	5.5	152	254
Q	0.58	77	111	190	305	2.8	4.0	6.8	11.5	228	330
R	1.1	132	198	345	540	4.7	7.1	12.3	19.5	158	241
U	1.1	210	335	570	880	7.6	12.0	20.3	32	275	368
V	2.3	430	700	1150	1725	15.3	25	42	63	238	343

Ordering info

1/4 — k1 — L — SS

↓ ↓ ↓ ↓

Specifications Nozzle series Capacity code Material

1/4 3/8 BRASS
SS 303

K2 Mixing Fluid Nozzle

material characteristic

- Constructed of carbon fiber-glass-reinforced Polypropylene of SS316.
- maximum operation temperature 120°C, 300°C for stainless steel.
- Corrosion resistance and aging resistance.

Functions

- provides a homogeneous fluid mix without the use of air agitation precluding oxidative decomposition of air agitation of the solutions.
- improves circulation of the turbulent flow and optimized mixture of the solutions.
- assures uniform mixture of solutions and improve product quality.

Design features

- Designed on the basis of the berboulli theory, fluid under pressure is pumped into the nozzle through its large flow opening, as the liquid exits the nozzle at high velocity, it draws surrounding solution through the nozzle's "flow-through" chamber that's designed to eliminate internal material build-up. The additional liquid flow mixes with the pumped solution. That is, the nozzle can pull in 4 gallons of surrounding solution for every 1 gallon pumped through the nozzle.

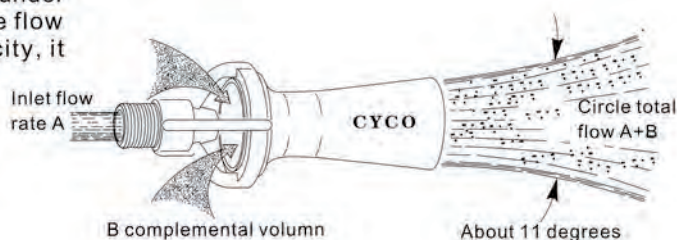

Performance Data

Inlet conn NPT or BSPT(M)	large acreage flow rate	hydraulic pressure input							
		0.5 Bar	1 Bar	1.5 Bar	2 Bar	2.5 Bar	3 Bar	3.5 Bar	4 Bar
1/4	Inlet flow rate(L / min) "A"	11.3	16.0	19.5	23	25	28	30	32
3/8		29	42	51	59	65	70	77	82
3/4		43	64	74	85	97	106	116	124
1-1/2		106	151	184	215	243	259	288	308
1/4	complemental volumn(L / min) "B"	42	59	72	84	93	102	110	118
3/8		116	168	204	236	260	280	308	328
3/4		172	256	298	340	388	424	464	496
1-1/2		424	604	736	860	972	1036	1152	1232
1/4	Circle total flow (L / min) A+B	53.3	75	91.5	107	118	130	140	150
3/8		145	210	255	295	325	350	385	410
3/4		215	320	370	425	485	530	580	620
1-1/2		530	755	920	1075	1215	1295	1440	1540
1/4	Effective range(m)	0.91	1.5	2.1	2.6	3.0	3.7	4.3	5.2
3/8		1.2	1.8	2.4	3.0	3.7	4.3	4.9	6.7
3/4		1.5	2.4	3.4	4.3	5.2	6.1	7.3	10.1
1-1/2		2.3	3.7	4.9	6.1	7.3	8.8	10.4	14.0

K2 Series

Model	Inlet conn (Inch)	L(mm)	D(mm)	D(mm)
K2 40	1/4	70	30	23
K2 60	3/8	115	50	38
K2 90	1/2	115	50	38
K2 130	3/4	165	65	50

Ordering info

K2 40 — **3/8** — **PP**

Model Entrance size Material

In large solution tank, annular distribution of the mix fluid nozzle is more effective than mono-distribution, and horizontal arrangement is the lowest efficiency. The mixing fluid nozzle should be installed at the bottom of the tank in order to get to a maximum circulation rate. Below are some of the typical distribution of the mixing fluid nozzle.

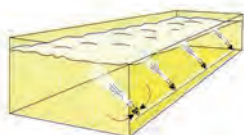

Rectangle or square stirred tank

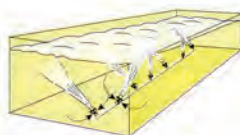

Stratification stirred tank

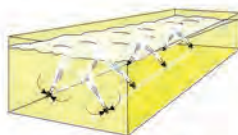

Spare parts rinse bath

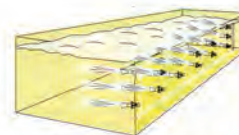

Grid structured plating bath

F Wind Jet Nozzle

Design Features

F WindJet Nozzle features a high impact, flat fan distribution of compressed air.

It is available in durable ABS plastic or aluminum alloy. It produces a quiet, efficient, controlled flat fan distribution of compressed air. The air stream is discharged through 16 precision orifices that ensure uniform distribution and spray pattern integrity.

It fits through 1/4 inch inlet connection with BSPT male screw thread. Two convenient mounting holes on the ABS model ensure correct positioning on the header or manifold or fixed applications, offering uniform distribution of air curtain.

Plastic F WindJet Nozzle withstands temperatures up to 77°C at 7 bar.

While aluminum alloy F WindJet Nozzle withstands temperature of 250°C and pressure about 30 bar.



Performance data

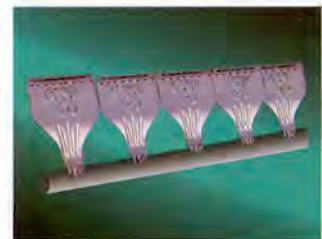
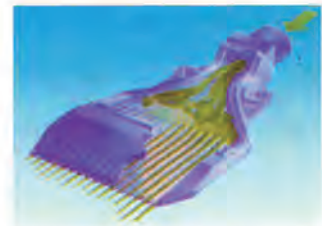
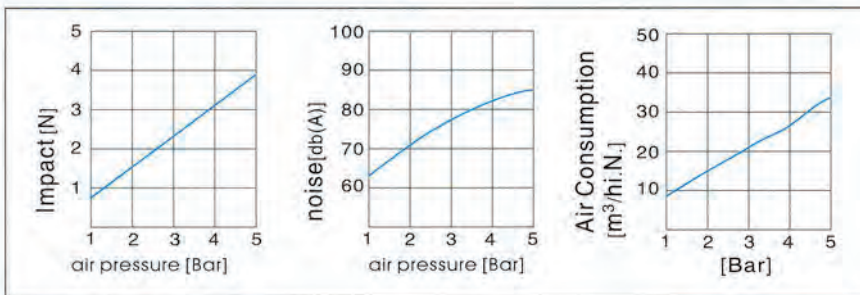

Dimensions

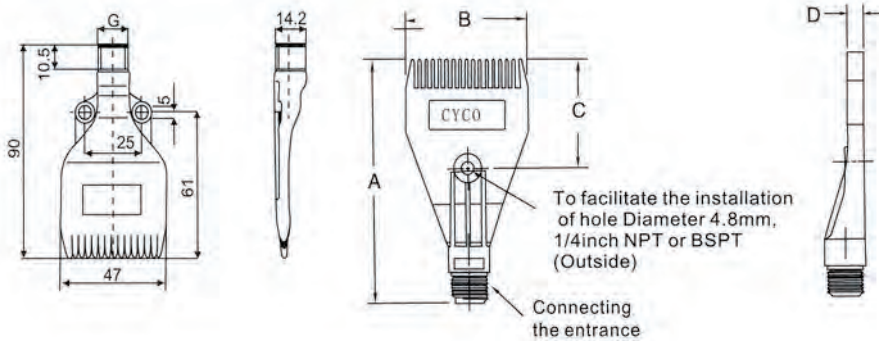

Application

- Parts cooling
- Parts drying
- Parts washing
- Material moving
- Threading

Ordering info

F1/4-ALMA	Aluminum alloy material
F1/4-ABS	Plastic material

K4 Tank Wash Nozzle

Design features

The 6160 fixed tank washing nozzle assembly features a large flow capacity for cleaning tanks up to 3.1 meters in diameter.

The flow rates can be changed by using the size of 1/4" or 1/8" full cone spray nozzle. The 6160 nozzle can pass through tank mouth of 130mm large in diameter.

For cleaning large tanks where extra-large flow capacity is used to clean the tank which diameter reaches 6.7 meter. It uses size of 1/2", 3/4" or 1" full cone to change the flow rates.

The 10250-1 nozzle assembly can pass through tank mouth of 230mm in diameter. For deep tanks the 10250-1 version is available with a 1.5 inch bottom outlet connection for use with a pipe extension and a 6160 nozzle assembly.

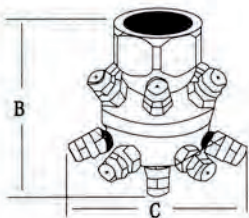
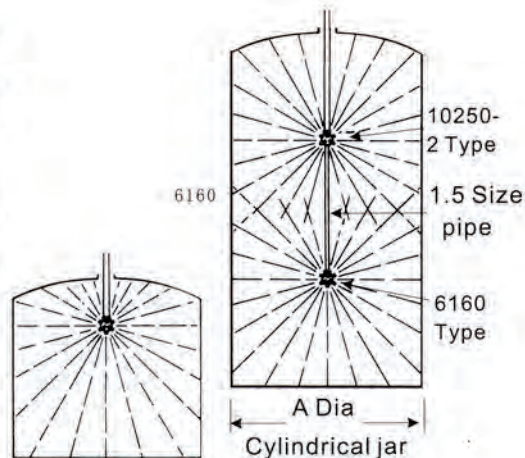

6160 Type



10250 Type

On Application

- Washbox defoaming
- Stock tank cleaning

Performance data

Pipe size NPT or BSPT (female)	Nozzle in the first order number	Flow rate (L/Min) at different pressures & Approx. Max. Tank Dia								Tank dia A (m)	Size	
		1.5 Bar		2 Bar		3 Bar		3.5 Bar			Height B (mm)	Dia C (mm)
		L/min	Diameter jar A (m)	L/min	Diameter jar A (m)	L/min	Diameter jar A (m)	L/min	Diameter jar A (m)			
3 Inch	10250-1-1/2	280	3.0	320	3.5	390	3.5	415	4.0	166	191	
	10250-1-3/4	580	3.5	660	4.0	800	4.5	860	5.0	174	210	
	10250-1-1	1000	4.0	1130	5.0	1370	6.0	1470	6.5	183	229	
1 1/2 Inch	6160-1/4GG5	35	40	48	52	1.2	114	114				
	6160-1/4GG10	70	80	97	104	2.1	114	114				
	6160-3/8GG22	155	177	215	230	3.0	121	127				

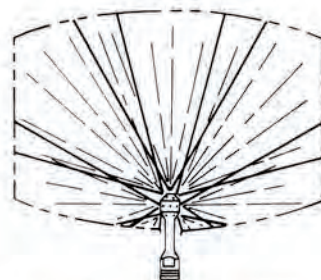

9800 model

Design Features

The 9800 washing nozzle is designed for effective cleaning of small containers. The nozzle is available in a choice of 15 or 21 full cone spray tips that can provide complete coverage of the interior surface of the small containers at pressure up to 10 bar.

The 9800 nozzle fits through a standard drum mouth. It can be installed on a self-driven drum washer. The biggest diameter of the spray tip is 35mm with a 16mm reduced neck design. Constructed of SS, this nozzle is an ideal application when max. corrosion resistance is required.

Dimensions and weight

Based on largest/heaviest version of each type

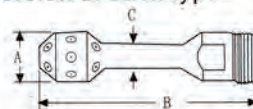

Nozzle serial number	9800-
Pipe joints NPT or BSPT (male)	1 Inch
A (mm)	35
B (mm)	156
C (mm)	16
Net Weight (Kg)	0.51

Performance data

Nozzle order number	Capacity (L/min)							
	1Bar	2Bar	3Bar	4Bar	5Bar	6Bar	7Bar	10Bar
9800-15-SS	-	-	-	20	23	25	26	31
9800-21-SS	-	-	-	28	31	34	36	43

36250



28250

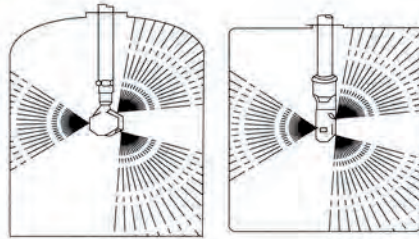

Container cleaning

Design features

Feature of 36250/28250
Compact Nozzle:

There are three high-pressure flat fan spray nozzles at the rotary spray head. The spray tip should be precisely oriented, in order to well wash all inner surface.

Therefore, there two models of nozzle can be used to effectively wash inner of small bottle, jarand barrel.

36250 Nozzle body is made of anticorrosive plastic, and bearing spring is made of hard stainless steel for max. wearable life and high pressure washing with max. Pressure of 5 bar.

28250 Impact Nozzle can pass inlet with diameter of 42 mm. The sector spray head with low flux has good effect to wash small container. The spray body is made of 316 stainless steel for max. wearable life and high pressure washing with max. pressure of 7 bar.

Size and weight

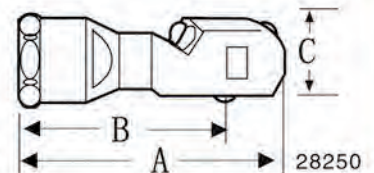
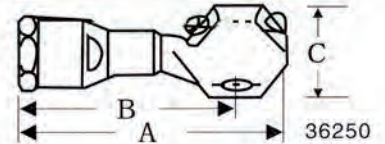

Performance Data

Nozzle Order Number	Capacity (L/min)					
	1Bar	1.5Bar	2Bar	2.5Bar	3Bar	4Bar
36250-STCN16-PP	49	59	68	76	84	94
36250-STCN18-PP	101	121	140	159	179	201
28250-STCN27-316SS	22	27	32	38	43	49
28250-STCN29-316SS	40	48	55	62	70	79

Nozzle Model	Joint NPT or BSPT (Female)	A (mm)	B (mm)	C (mm)	Hexagon (mm)	Net Weight (KG)
36250-	3/4inch	145	115	85	75	0.55
28250-	3/4inch	122	100	56	44.5	0.68

Design features

19250 Compact Nozzle can generate self-rotary drive for side spraying by two flat fan spray tip with 25 mm hole. The top hatch makes a whole global spraying available.

The main material is 316 stainless steel, while axletree and axletree circle are made of rigid stainless steel for longest wearability life.

The max. pressure is 13 bar and max temperature is 180 centigrade.

19250

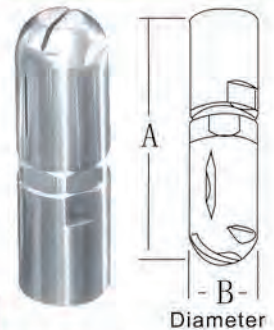

Performance Data

Nozzle Order Number	Capacity (L/min)							
	1.5Bar	3Bar	4Bar	5Bar	6Bar	8Bar	10Bar	12Bar
19250-STCN5-316SS	14.0	19.7	23	25	28	32	36	39
19250-STCN6-316SS	15.9	22	26	29	32	37	41	45
19250-STCN7-316SS	19.5	28	32	36	39	45	50	55
19250-STCN8-316SS	22	32	36	41	45	52	58	63
19250-STCN9-316SS	28	39	46	51	56	64	72	79

Size and weight

Nozzle Number	19250
A(mm)	89
B(mm)	25.4
Net Weight(KG)	0.23



Ordering info

The above three models can be made of brass. For other materials, please mark out.

K5 Spray-Dry Nozzle

The nozzle body is mainly made of stainless steel, with harden SS, alloy or gem for accessories. With a swirl leading chest inside, the liquid is changed into centrifugal mist with little spraying drop. It can close contact with hot air, and widely applied in food, ceramic, pharmacy, Chemical, dyeing and metallurgy, etc.



K5 for drying spraying Nozzle

K5 Series					
Structure	SS 303 for nozzle body, and selective materials for cover, taper or spray hole.				
Material	SS303, SS316, Harden SS, Alloy or Gem				
A Spec	Inlet joint female/male screw thread		Size		
	1/4Inch	3/8Inch	A Hexagon(mm) 25.4	B length 41.5or47.6	Net Weight 0.142/0.1156

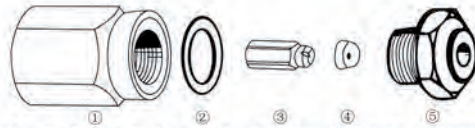
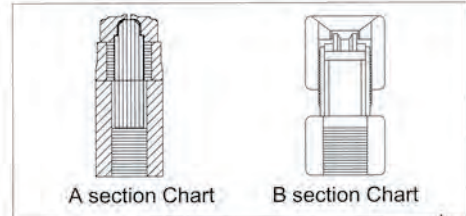

1, Holder 2, Sealing Cushion 3, Rotary Core 4, Inlayer 5, Nozzle tip
Dry Nozzle Head Diagram

Performance Data

Inlet conn NPT or BSPT(M)	Capacity	Rating Spray Hole Dia. (mm)	Capacity (L/min)															
			3Bar	4Bar	5.5Bar	7Bar	10Bar	15Bar	20Bar	35Bar	50Bar	70Bar	100Bar	135Bar	170Bar	210Bar	275Bar	340Bar
1/4	1	1.4	0.67	0.77	0.91	1.0	1.2	1.5	1.7	2.3	2.7	3.2	3.9	4.5	5.1	5.6	6.4	7.1
			68°	72°	73°	74°	75°	76°	71°	67°	62°	57°	55°	53°	51°	50°	48°	46°
3/8	1.5	1.8	1.1	1.2	1.4	1.6	1.9	2.4	2.8	3.6	4.4	5.1	6.2	7.2	8.0	8.9	10.2	11.4
			78°	82°	83°	84°	80°	77°	75°	72°	65°	59°	57°	55°	53°	51°	49°	47°
1/4	2	2.0	1.3	1.5	1.8	2.1	2.5	3.0	3.5	4.6	5.5	6.5	7.8	9.0	10.1	11.2	12.9	14.3
			77°	81°	81°	81°	80°	79°	73°	68°	62°	57°	55°	53°	51°	50°	48°	46°
1/4	3	2.4	2.1	2.4	2.8	3.1	3.7	4.6	5.3	7.0	8.4	9.9	11.9	13.8	15.5	17.2	20	22
			78°	79°	79°	78°	77°	76°	67°	59°	53°	48°	46°	44°	41°	39°	37°	35°
1/4	4	2.8	2.6	3.0	3.5	4.0	4.8	5.8	6.7	8.9	10.6	12.6	15.0	17.5	19.6	22	25	28
			76°	76°	77°	78°	77°	76°	67°	59°	53°	48°	46°	44°	41°	38°	35°	33°
1/4	5	3.3	3.4	3.9	4.5	5.1	6.1	7.5	8.7	11.5	13.7	16.2	19.4	23	25	28	32	36
			91°	91°	88°	86°	82°	79°	71°	63°	56°	50°	46°	45°	43°	40°	37°	34°
1/4	6	3.5	4.0	4.6	5.4	6.1	7.3	8.9	10.3	13.6	16.3	19.3	23	27	30	33	38	42
			89°	89°	86°	83°	80°	78°	69°	61°	56°	52°	48°	46°	43°	42°	40°	38°
1/4	7	3.6	4.3	5.0	5.8	6.6	7.9	9.6	11.1	14.7	17.6	21	25	29	32	36	41	46
			91°	88°	85°	83°	80°	78°	69°	60°	59°	58°	55°	53°	51°	48°	45°	42°
1/4	8	4.0	5.4	6.2	7.3	8.2	9.8	12.0	13.9	18.3	22	26	31	36	40	45	51	57
			92°	89°	86°	83°	78°	74°	65°	57°	54°	52°	51°	50°	48°	46°	44°	42°
1/4	10	4.5	7.1	8.3	9.7	10.9	13.0	16.0	18.4	24	29	35	41	48	54	60	68	76
			94°	87°	85°	83°	79°	75°	67°	59°	57°	55°	48°	46°	44°	42°	40°	38°
1/4	15	5.4	11.6	13.4	15.7	17.7	21	26	30	40	47	56	67	78	87	97	111	123
			86°	82°	80°	78°	73°	68°	60°	52°	51°	50°	46°	44°	43°	40°	36°	32°
1/4	20	6.4	17.8	21	24	27	32	40	46	61	73	86	103	119	134	149	170	189
			80°	80°	80°	80°	72°	64°	55°	47°	46°	45°	42°	39°	37°	35°	30°	32°

Ordering info

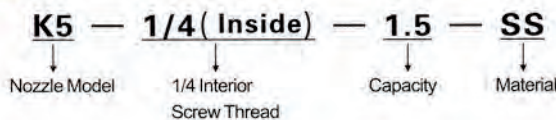

K Series Spray Nozzle For Special Purpose

High pressure ceramic solid stream nozzle & Deckle edge trimming solid stream nozzle

**CY38170 Brass
With ceramic core**



**CY38171 header and
CY 38172 strainer**



Needle ruby core



HRBY

**Tungsten
alloy**



TCK

**Ceramic
core**



BCTC

This kind of nozzle is used for the trimming of the paper that supply a precise, clean cut. It can produce a straight needle solid stream. It can work at high pressure of 140bar. This nozzle orifice material we have the SS316 and ceramic.

Performance Data

nozzle type	Serial number	orifice dia. (mm)	Capacity (L/min)									
			7Bar	10Bar	20Bar	30Bar	40Bar	50Bar	60Bar	70Bar	100Bar	138Bar
The only aperture ruby	15	0.38	0.17	0.21	0.29	0.36	0.41	0.46	0.50	0.54	0.65	0.76
CY38170/CY38171	20	0.51	0.31	0.36	0.52	0.63	0.73	0.82	0.89	0.96	1.2	1.4
CY38170/CY38171	25	0.64	0.48	0.57	0.81	0.99	1.1	1.3	1.4	1.5	1.8	2.1
CY38170/CY38171	30	0.76	0.69	0.82	1.2	1.4	1.6	1.8	2.0	2.2	2.6	3.1
CY38170/CY38171	35	0.89	0.93	1.1	1.6	1.9	2.2	2.5	2.7	3.0	3.5	4.2
CY38170/CY38171	40	1.0	1.2	1.5	2.1	2.5	2.9	3.3	3.6	3.9	4.6	5.4
CY38170/CY38171	45	1.1	1.5	1.9	2.6	3.2	3.7	4.1	4.5	4.9	5.8	6.9
CY38170/CY38171	50	1.3	1.9	2.3	3.2	4.0	4.6	5.1	5.6	6.0	7.2	8.5
CY38170/CY38171	60	1.5	2.8	3.3	4.6	5.7	6.6	7.3	8.0	8.7	10.4	12.2

Dimension

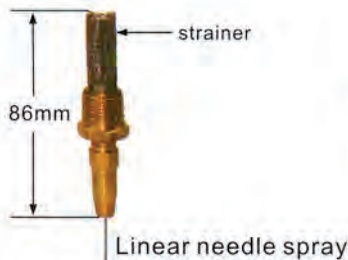

CY 28170 model header with strainer

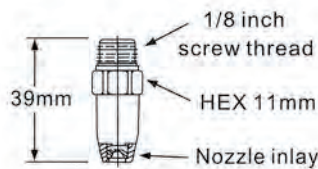

CY 38171 Type Needle without water strainer

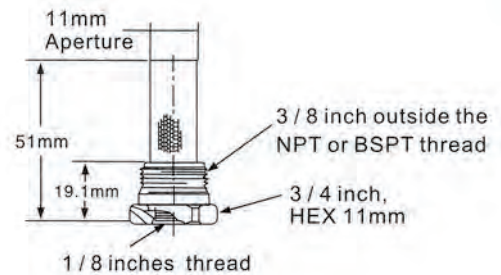

CY 38172 Type Adapter / strainer combination

Note Material

CY 38170 brass nozzles for the main materials, filter materials for stainless steel, ceramic nozzle for the inlay.

Ordering info

Order package

CY38170 — 20 — CER

Model Serial number Ceramic inlay

Only ordered water needle

CY38171 — 20 — CER

Model Serial number Ceramic inlay

Only order strainer

CY 38172 - 20

Model Serial number

Shower high pressure needle nozzle

CY27149 Type



nozzle without gasket type

CY64160Type



nozzle with gasket type

CY50709 Type



Nozzle without gasket type

CY48546/CY39350 Type



nozzle with gasket type

Application

- High pressure cleaning of long net part
- High pressure cleaning of squeezing part
- Cleaning of blind hole roller
- Cleaning of groove roller

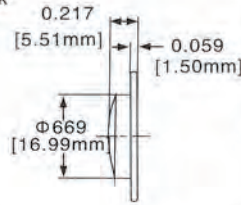
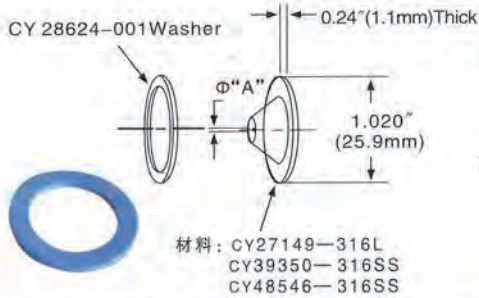

CY27149/CY39350/CY48546 Type

Common SS | SS with ceramic | SS with ruby

50709Type

SS with ruby

CY27149 Performance Data

Nozzle size	Orifice diameter (mm)	Capacity(L/min)					Spray angle 4bar
		1.5Bar	3Bar	7Bar	20Bar	55Bar	
CY27149-00004	0.3	0.11	0.16	0.24	0.41	0.68	0°
CY27149-00007	0.4	0.20	0.28	0.42	0.71	1.2	
CY27149-00009	0.5	0.25	0.36	0.54	0.92	1.5	
CY27149-00001	0.6	0.36	0.51	0.78	1.3	2.2	
CY27149-00002	1.0	0.64	0.91	1.4	2.3	3.9	
CY27149-00003	1.2	0.92	1.3	2.0	3.4	5.6	
CY27149-00004	1.5	1.2	1.7	2.6	4.4	7.3	
CY27149-00008	1.9	2.2	3.1	4.8	8.1	13.4	
CY27149-0012	2.4	3.5	4.9	7.5	12.6	21	
CY27149-0020	3.2	5.5	7.8	11.9	20	33	

CY39350 Performance Data

Nozzle size	Orifice diameter (mm)	Capacity (L/min)					Spray angle 4bar
		1.5Bar	3Bar	7Bar	20Bar	55Bar	
CY39350-00005	0.5	0.14	0.20	0.31	0.52	0.86	0°
CY39350-00008	0.64	0.22	0.31	0.45	0.81	1.34	
CY39350-00001	0.76	0.32	0.45	0.69	1.16	1.93	
CY39350-00015	0.9	0.43	0.61	0.94	1.58	2.62	
CY39350-00002	1.0	0.56	0.80	1.22	2.06	3.42	
CY39350-00025	1.1	0.72	1.01	1.54	2.61	4.33	
CY39350-00003	1.3	0.88	1.25	1.91	3.22	5.34	
CY39350-00045	1.5	1.27	1.80	2.75	4.64	7.7	

CY48546 Performance Data

Nozzle Model	Inch
CY48546-00003-316RBY	0.015" [0.38mm]
CY48546-00005-316RBY	0.020" [0.51mm]
CY48546-00008-316RBY	0.025" [0.64mm]
CY48546-00011-316RBY	0.030" [0.76mm]
CY48546-00015-316RBY	0.035" [0.89mm]
CY48546-00020-316RBY	0.040" [1.02mm]
CY48546-00025-316RBY	0.045" [1.14mm]

CY50709 Performance Data

Nozzle Model	Inch
CY50709-00003-316RBY	0.015" [0.38mm]
CY50709-00005-316RBY	0.020" [0.51mm]
CY50709-00008-316RBY	0.025" [0.64mm]
CY50709-00011-316RBY	0.030" [0.76mm]
CY50709-00015-316RBY	0.035" [0.89mm]
CY50709-00020-316RBY	0.040" [1.02mm]
CY50709-00025-316RBY	0.045" [1.14mm]

Ordering info

When ordering ordinary stainless steel nozzles

CY27149-0002-316L

Model Series Material

When ordering ceramic inlay nozzle

CY39350-0002-316SS

Model Series Material

When ordering Ruby inlay nozzle

CY48546-00020-316RBY

Model Size 316SS+ Ruby inlay

CY50709-00020-316RBY

Model Size 316SS+Ruby inlay

When asked order pads with the nozzle size one, please indicate special.

Pagoda High Pressure Needle Nozzle

一、 Basic Style

CY19124/CYB1/4PT



Common stainless steel

CYB1/4 TL



Common stainless steel for lengthen type

CYB1/4PT-SSCER



Standard SS with ceramic

CYB1/4PTL-SSCER



Common SS with ceramic for lengthen type

CY48460/CYB1/4PT-SSRBY



Standard SS with ruby

CYB1/4PTL-SSRBY



Common SS with ruby for lengthen type

二、 Basic size

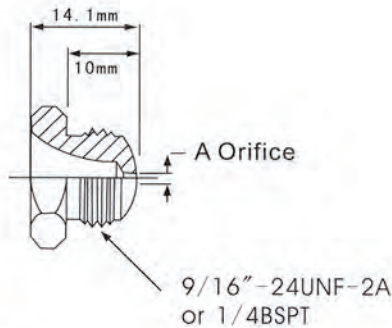
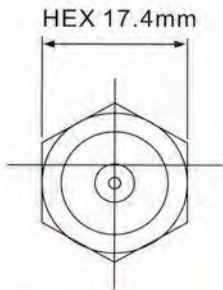

Application

- High pressure swing cleaning of long net part
- High pressure swing cleaning of squeezing part
- Cleaning of blind hole roller
- Cleaning of groove roller

Performance Data

Nozzle size	Equivalent diameter nozzle	Capacity liters per minute								
		3Bar	4Bar	5Bar	7Bar	15Bar	30Bar	40Bar	50Bar	60Bar
CY19124-14-316SS	0.36	0.12	0.13	0.15	0.17	0.25	0.37	0.42	0.47	0.51
CY19124-28-316SS	0.71	0.42	0.48	0.54	0.63	0.93	1.3	1.5	1.7	1.9
CY19124-33-316SS	0.84	0.62	0.73	0.81	0.95	1.4	2.0	2.4	2.7	2.9
CY19124-40-316SS	1.02	0.89	1.0	1.1	1.4	2.0	2.8	3.2	3.6	3.9
CY19124-55-316SS	1.40	1.6	1.9	2.1	2.4	3.6	5.0	5.8	6.5	7.0
CY19124-70-316SS	1.78	2.7	3.1	3.5	4.2	6.1	8.8	10	11	13
CY19124-94-316SS	2.39	4.5	5.2	5.9	7.0	10	15	18	20	22
CY19124-125-316SS	3.18	7.3	8.5	9.6	11	17	25	30	33	37

PT Performance Data <BSPT1/4 Thread>

Nozzle Model		Orifice diameter (mm)	Capacity(L/min)											
			3Bar	5Bar	7Bar	10Bar	15Bar	20Bar	30Bar	40Bar	50Bar	60Bar	70Bar	80Bar
Standard	lengthen	0.8	0.54	0.70	0.83	1.00	1.22	1.41	1.73	2.00	2.23	2.45	2.64	2.83
		0.9	0.69	0.89	1.05	1.26	1.55	1.79	2.19	2.53	2.83	2.10	3.35	3.58
CYB1/4PT-SS	CYB1/4PTL-SS	1.0	0.85	1.10	1.30	1.56	1.91	2.21	2.70	3.12	3.49	3.83	4.13	4.42
		1.2	1.23	1.59	1.88	2.25	2.75	3.18	3.90	4.50	5.03	5.51	5.95	6.36
CYB1/4PT-SSCER	CYB1/4PTL-SSCER	1.5	1.92	2.48	2.94	3.51	4.30	4.97	6.09	7.03	7.86	8.61	9.30	9.95
		1.8	2.77	3.58	4.23	5.06	6.20	7.16	8.77	10.1	11.3	12.4	13.4	14.3
CYB1/4PT-RBY	CYB1/4PTL-RBY	2.0	3.42	4.42	5.23	6.25	7.66	8.84	10.8	12.5	13.9	15.3	16.4	17.6

CY 48460 Ruby Inlay

Nozzle Model	Inch	Nozzle Model	Inch
CY48460-15-316RBY	0.015" [0.38mm]	CY48460-35-316RBY	0.035" [0.89mm]
CY48460-20-316RBY	0.020" [0.51mm]	CY48460-40-316RBY	0.040" [1.02mm]
CY48460-25-316RBY	0.025" [0.64mm]	CY48460-40-316RBY	0.045" [1.14mm]
CY48460-30-316RBY	0.030" [0.76mm]		

Ordering info

一、Stainless Steel Series

1、CYM19124-40-316SS(M14x1.0 thread connection)

Model Aperture Material
Series

2、CYB19124-40-316SS (BSPT 1/4 Thread Interface)

Model Aperture Material
Series

3、CY19124-40-316SS(9/16-24UNF-2A thread connection)

Model Aperture Material
Series

4、CYB1/4PT-SS1.0 (BSPT 1/4 Thread Interface)

Standard Aperture
Series

二、Ceramic inlay Series

6、CYB1/4PT-SSCER-1.0(BSPT1/4 Thread Interface)

Standard Ceramic Aperture
inlay stainless steel

5、CYB1/4PTL-SS1.0 (BSPT 1/4 Thread Interface)

Model Aperture
Series

7、CYB1/4PTL-SSCER-1.0 (BSPT 1/4 Thread Interface)

lengthen Ceramic Aperture
inlay stainless steel

三、Ruby Series

8、CYB1/4PT-SSRBY-1.0(BSPT1/4 Thread Interface)

Standard Ruby the Aperture
main stainless steel inlay

9、CYB1/4PTL-SSRBY-1.0 (BSPT 1/4 Thread Interface)

lengthen Ruby the Aperture
main stainless steel inlay

10、CY48460-20-316RBY(9/16-24UNF-2A Thread Interface)

Model Aperture 316 stainless
Series steel main
Ruby inlay

CCTC Series disc flat fan nozzle

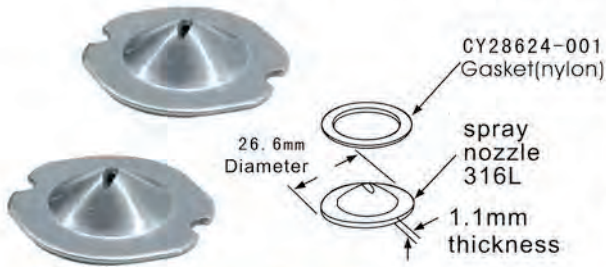

CCTC nozzle is specially designed for brush type showers. Spray angle of 0°, 30°, 60° and 75° are available. It needs to use the CCTC28624-001 gasket when Install the nozzle.

Ordering info

CCTC — CY6008 — 316L

Model Spray angle and Capacity code Material

Performance Data

Nozzle size	Orifice diameter (mm)	Capacity(L/min)					Spray angle 4bar
		1.5Bar	3Bar	7Bar	20Bar	55Bar	
CCTC-0002	1.0	0.64	0.91	1.4	2.3	3.9	0°
CCTC-0003	1.2	0.92	1.3	2.0	3.4	5.6	
CCTC-0004	1.5	1.2	1.7	2.6	4.4	7.3	
CCTC-0006	1.8	1.7	2.4	3.7	6.2	10.3	
CCTC-0008	2.0	2.2	3.1	4.8	8.1	13.4	
CCTC-0010	2.2	2.8	4.0	6.2	10.4	17.2	
CCTC-3012	2.5	3.5	4.9	7.5	12.6	21	30°
CCTC-3016	2.8	4.5	6.3	9.7	16.4	27	
CCTC-3020	3.0	5.5	7.8	11.9	20	33	
CCTC-3025	3.5	7.2	10.1	15.5	26	43	
CCTC-3031	4.0	8.8	12.4	18.9	32	53	
CCTC-3040	4.5	11.3	15.9	24	41	68	
CCTC-3049	5.0	13.7	19.4	30	50	83	
CCTC-3078	6.0	22	31	48	81	135	
CCTC-3099	7.0	29	39	60	101	167	
CCTC-30124	8.0	35	49	75	126	210	
CCTC-6002	1.0	0.64	0.91	1.4	2.3	3.9	60°
CCTC-6003	1.2	0.92	1.3	2.0	3.4	5.6	
CCTC-6004	1.5	1.2	1.7	2.6	4.4	7.3	
CCTC-6006	1.8	1.7	2.4	3.7	6.2	10.3	
CCTC-6008	2.0	2.2	3.1	4.8	8.1	13.4	
CCTC-6010	2.2	2.8	4.0	6.2	10.4	17.2	
CCTC-6012	2.5	3.5	4.9	7.5	12.6	21	
CCTC-6016	2.8	4.5	6.3	9.7	16.4	27	
CCTC-6020	3.0	5.5	7.8	11.9	20	33	
CCTC-6025	3.5	7.2	10.1	15.5	26	43	
CCTC-6031	4.0	8.8	12.4	18.9	32	53	
CCTC-3040	4.5	11.3	15.9	24	41	68	
CCTC-6049	5.0	13.7	19.4	30	50	83	
CCTC-6078	6.0	22	31	47	80	133	
CCTC-6099	7.0	28	39	60	101	167	
CCTC-60124	8.0	35	49	75	126	210	
CCTC-7502	1.0	0.64	0.91	1.4	2.3	3.9	75°
CCTC-7503	1.2	0.92	1.3	2.0	3.4	5.6	
CCTC-7504	1.5	1.2	1.7	2.6	4.4	7.3	
CCTC-7506	1.8	1.7	2.4	3.7	6.2	10.3	
CCTC-7508	2.0	2.2	3.1	4.8	8.1	13.4	
CCTC-7510	2.2	2.8	4.0	6.2	10.4	17.2	
CCTC-7512	2.5	3.5	4.9	7.5	12.6	21	
CCTC-7516	2.8	4.5	6.3	9.7	16.4	27	
CCTC-7520	3.0	5.5	7.8	11.9	20	33	
CCTC-7525	3.5	7.2	10.1	15.5	26	43	
CCTC-7531	4.0	8.8	12.4	18.9	32	53	
CCTC-7541	4.5	11.3	15.9	24	41	68	
CCTC-7549	5.0	13.7	19.4	30	50	83	
CCTC-7578	6.0	22	31	48	81	133	
CCTC-7599	7.0	28	39	60	101	167	
CCTC-75124	8.0	35	49	75	126	210	

Low Pressure Flat Fan Spray Nozzle

CTC Fan Spray Nozzle

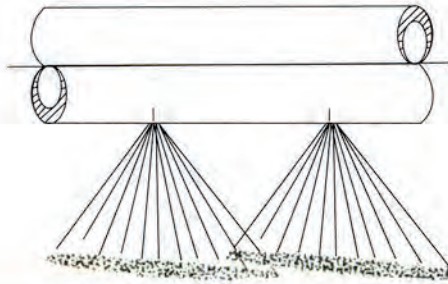

Product Description

When the distance between the spray poles and the nets or the blanket is small, this nozzle is your best choice. It is made of SS303 or SS316 which is durable and incorrodible.

CTC Performance Data

Model of Nozzle	Equivalent aperture (mm)	Material		Capacity(L/min)								Spray angle under pressure of 3kg
		*SS	316SS	1Bar	2Bar	3Bar	4Bar	5Bar	6Bar	7Bar	10Bar	
CTC-2510		*		2.3	3.2	3.9	4.6	5.1	5.6	6.0	7.2	25°
CTC-3580	6.4	*		18.2	26	32	36	41	45	48	58	35°
CTC-4040		*		9.1	12.9	15.8	18.2	20	22	24	29	40°
CTC-4047	4.7	*		10.7	15.1	18.6	21	24	26	28	34	
CTC-4067		*		15.3	22	26	31	34	37	40	48	
CTC-4070	5.5	*		16.0	23	28	32	36	39	42	50	
CTC-4085	6.4	*		19.4	27	34	39	43	47	51	61	43°
CTC-4308	1.9	*		1.8	2.6	3.2	3.6	4.1	4.5	4.8	5.8	50°
CTC-4313	2.4	*	*	3.0	4.2	5.1	5.9	6.6	7.3	7.8	9.4	
CTC-50033	1.2	*		0.75	1.1	1.3	1.5	1.7	1.8	2.0	2.4	
CTC-5024	3.2	*		5.5	7.7	9.5	10.9	12.2	13.4	14.5	17.3	55°
CTC-5033	4.0	*		7.5	10.6	13.0	15.0	16.8	18.4	19.9	24	
CTC-5037		*		8.4	11.9	14.6	16.9	18.9	21	22	27	58°
CTC-55054	1.6	*		1.2	1.7	2.1	2.5	2.8	3.0	3.3	3.9	
CTC-5508	1.9	*		1.8	2.6	3.2	3.6	4.1	4.5	4.8	5.8	60°
CTC-5824	3.2	*	*	5.5	7.7	9.5	10.9	12.2	13.4	14.5	17.3	
CTC-5833	4.0	*	*	7.5	10.6	13.0	15.0	16.8	18.4	19.9	24	65°
CTC-60054	1.6	*	*	1.2	1.7	2.1	2.5	2.8	3.0	3.3	3.9	
CTC-65054	1.6	*	*	1.2	1.7	2.1	2.5	2.8	3.0	3.3	3.9	
CTC-6513	2.4	*	*	3.0	4.2	5.1	5.9	6.6	7.3	7.8	9.4	
CTC-6519	2.8	*	*	4.3	6.1	7.5	8.7	9.7	10.6	11.5	13.7	68°
CTC-6533	4.0	*	*	7.5	10.6	13.0	15.0	16.8	18.4	19.9	24	
CTC-6550	4.7	*	*	11.4	16.1	19.7	23	25	28	30	36	70°
CTC-6570	5.5	*	*	16.0	23	28	32	36	39	42	50	
CTC-6824	3.2	*	*	5.5	7.7	9.5	10.9	12.2	13.4	14.5	17.3	
CTC-6840		*	*	9.1	12.9	15.8	18.2	20	22	24	29	
CTC-6864		*	*	14.6	21	25	29	33	36	39	46	80°
CTC-6870	5.5	*	*	16.0	23	28	32	36	39	42	50	
CTC-70023	1.0	*	*	0.52	0.74	0.91	1.0	1.2	1.3	1.4	1.7	90°
CTC-80032	1.2	*	*	0.73	1.0	1.3	1.5	1.6	1.8	1.9	2.3	
CTC-80054	1.6	*	*	1.2	1.7	2.1	2.5	2.8	3.0	3.3	3.9	
CTC-8008	1.9	*	*	1.8	2.6	3.2	3.6	4.1	4.5	4.8	5.8	
CTC-80084	1.9	*	*	1.9	2.7	3.3	3.8	4.3	4.7	5.1	6.1	
CTC-8013	2.4	*	*	3.0	4.2	5.1	5.9	6.6	7.3	7.8	9.4	
CTC-8024	3.2	*	*	5.5	7.7	9.5	10.9	12.2	13.4	14.5	17.3	
CTC-8033	4.0	*	*	7.5	10.6	13.0	15.0	16.8	18.4	19.9	24	
CTC-8040		*	*	9.1	12.9	15.8	18.2	20	22	24	29	
CTC-90016	0.79	*	*	0.36	0.52	0.63	0.73	0.82	0.89	0.96	1.2	90°
CTC-90054	1.6	*	*	1.2	1.7	2.1	2.5	2.8	3.0	3.3	3.9	
CTC-9013	2.4	*	*	3.0	4.2	5.1	5.9	6.6	7.3	7.8	9.4	

Dimension and the installation



Front side



Back side

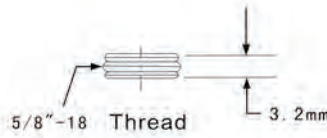

Cut Side

二、CTY Performance Data

Model of Nozzle	Equivalent aperture (mm)	Capacity(L/min)								spray angle under pressure of 3kg
		10Bar	20Bar	30Bar	40Bar	60Bar	80Bar	100Bar	150Bar	
CTY-35084	0.076	0.42	0.59	0.73	0.84	1.0	1.2	1.3	1.6	35°
CTY-3524	0.125	1.2	1.7	2.0	2.45	2.9	3.3	3.7	4.6	35°
CTY-3572	0.218	3.5	5.0	6.2	7.2	8.8	10.1	11.3	14.0	35°
CTY-4513	0.093	0.66	0.93	1.1	1.3	1.6	1.8	2.0	2.5	43°
CTY-3513	0.093	0.65	0.93	1.1	1.3	1.6	1.8	2.0	2.5	50°
CTY-3524	0.125	1.2	1.7	2.0	2.4	2.9	3.3	3.7	4.6	50°
CTY-55054	0.062	0.27	0.38	0.47	0.54	0.66	0.76	0.84	1.0	55°
CTY-6513	0.093	0.66	0.93	1.1	1.3	1.6	1.8	2.0	2.5	65°
CTY-6824	0.125	1.2	1.7	2.0	2.4	2.9	3.3	3.7	4.6	68°
CTY-70054	0.062	0.27	0.38	0.47	0.54	0.66	0.76	0.84	1.0	70°
CTY-8013	0.093	0.65	0.93	1.1	1.3	1.6	1.8	2.0	2.5	80°
CTY-8024	0.125	1.2	1.7	2.0	2.4	2.9	3.3	3.7	4.6	80°
CTY-8054	0.187	2.7	3.8	4.7	5.4	6.6	7.6	8.5	10.5	80°
CTY-90054	0.062	0.27	0.38	0.47	0.54	0.66	0.76	0.84	1.0	90°
CTY-9013	0.093	0.66	0.93	1.1	1.3	1.6	1.8	2.0	2.5	90°

Application

- Low pressure washing
- knife sopping and lubricating

Ordering info

CTC — 6513 — SS
 nozzle Serial Material
 model number code
 Material: 303SS-SS
 316SS-316SS

CTY — 6513 — SS
 nozzle Serial Material
 model number code
 Material: 303SS-SS
 316SS-316SS

Dimension and the installation

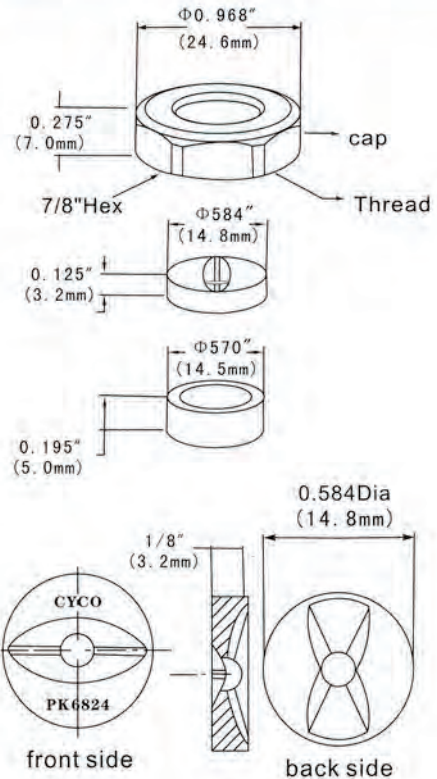

EQ Series Self-clean Spay Nozzle

Features

It features an automatic increase of pressure in case of orifice clogging, thus the orifice diameter is enlarged and the clogging matters are cleared away. Then the spray orifice returns to normal. In the elliptical orifice design, the axis of the spray pattern is a continuation of the axis of the inlet pipeconnection. The tapering edges of the flat fan spray nozzles are useful in establishing overlapping patterns between adjacent sprays on a mutiple nozzle header.

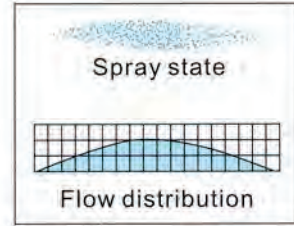

Common applications:

- Paper making: meshwork cleaning, felt cleaning and roller cleaning
- Steel plate cleaning in Continuous Casting Machine.
- Water treatment: filter screen squeezer cleaning, conveyor, squeezer cleaning, deaerating and surface cleaning of aerating filter-sand.
- Electronics: PCB cleaning
- Automotive and household appliances: pretreatment before coating.

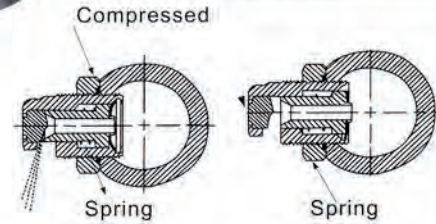

Ordering info

EQ — 1506 — 316SS

nozzle type Orifice diameter Material

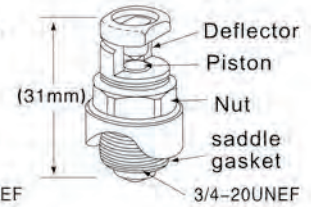
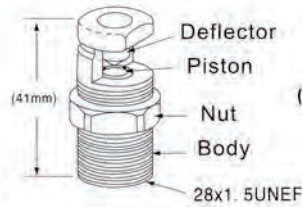
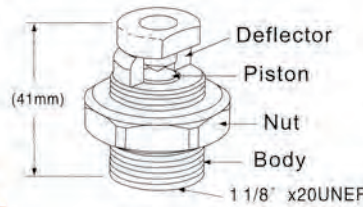

Performance Data

spray angle at 2.8 Bar	Orifice diameter	Capacity(L/min)														
		1.5Bar	2Bar	2.5Bar	3Bar	3.5Bar	4Bar	4.5Bar	5Bar	4.5Bar	6Bar	7Bar	8Bar	10Bar	15Bar	
0°	00012	0.034	0.039	0.043	0.047	0.051	0.055	0.058	0.061	0.064	0.067	0.072	0.077	0.086	0.11	
	00026	0.073	0.084	0.094	0.10	0.11	0.12	0.125	0.13	0.14	0.15	0.16	0.17	0.19	0.23	
	00053	0.15	0.17	0.19	0.21	0.23	0.24	0.26	0.27	0.28	0.30	0.32	0.34	0.38	0.47	
	00007	0.20	0.23	0.25	0.28	0.30	0.32	0.34	0.36	0.37	0.39	0.42	0.45	0.50	0.62	
	0001	0.28	0.32	0.36	0.39	0.43	0.46	0.48	0.51	0.53	0.56	0.60	0.64	0.72	0.88	
	00017	0.47	0.55	0.61	0.67	0.72	0.77	0.82	0.87	0.91	0.95	1.0	1.1	1.2	1.5	
	0002	0.56	0.64	0.72	0.79	0.85	0.91	0.97	1.0	1.07	1.1	1.2	1.3	1.4	1.8	
	00025	0.70	0.81	0.90	0.99	1.0	1.1	1.2	1.3	1.34	1.4	1.5	1.6	1.8	2.2	
	00032	0.89	1.0	1.2	1.3	1.4	1.5	1.55	1.6	1.7	1.8	1.9	2.1	2.3	2.8	
	00043	1.2	1.4	1.5	1.7	1.8	2.0	2.1	2.2	2.3	2.4	2.6	2.8	3.1	3.8	
	0005	1.4	1.6	1.8	2.0	2.1	2.3	2.4	2.5	2.7	2.8	3.0	3.2	3.6	4.4	
	0006	1.7	1.9	2.2	2.4	2.6	2.7	2.9	3.1	3.2	3.3	3.6	3.9	4.3	5.3	
	0008	2.2	2.6	2.9	3.2	3.4	3.6	3.9	4.1	4.3	4.5	4.8	5.2	5.8	7.1	
0010	2.8	3.2	3.6	3.9	4.3	4.6	4.8	5.1	5.3	5.6	6.0	6.4	7.2	8.8		
15°	1506	1.7	1.9	2.2	2.4	2.6	2.7	2.9	3.1	3.2	3.3	3.6	3.9	4.3	5.3	
	30°	3005	1.4	1.6	1.8	2.0	2.1	2.3	2.4	2.5	2.7	2.8	3.0	3.2	3.6	4.4
		3013	3.6	4.2	4.7	5.1	5.5	5.9	6.3	6.6	6.9	7.3	7.8	8.4	9.4	11.5
		3014	3.9	4.5	5.0	5.5	6.0	6.4	6.8	7.1	7.5	7.8	8.4	9.0	10.1	12.4
3040		11.2	12.9	14.4	15.8	17.1	18.2	19.3	20	21	22	24	26	29	35	
40°	4012	3.3	3.9	4.3	4.7	5.1	5.5	5.8	6.1	6.4	6.7	7.2	7.7	8.6	10.6	
	1013	3.6	4.2	4.7	5.1	5.5	5.9	6.3	6.6	6.9	7.3	7.8	8.4	9.4	11.5	
	4014	3.9	4.5	5.0	5.5	6.0	6.4	6.8	7.1	7.5	7.8	8.4	9.0	10.1	12.4	
	4020	5.6	6.4	7.2	7.9	8.5	9.1	9.7	10.2	10.7	11.2	12.1	12.9	14.4	17.7	
	4032	8.9	10.3	11.5	12.6	13.6	14.6	15.5	16.3	17.1	17.9	19.3	21	23	28	
4045	12.6	14.5	16.2	17.8	19.2	21	22	23	24	22	27	29	32	40		
45°	4516	4.5	5.2	5.8	6.3	6.8	7.3	7.7	8.2	8.6	8.9	9.6	10.3	11.5	14.1	
	4525	7.0	8.1	9.0	9.9	10.7	11.4	12.1	12.7	13.4	14.0	15.1	16.1	18.0	22	
	4542	11.7	13.5	15.1	16.6	17.9	19.1	20	21	22	23	25	27	30	37	
50°	5032	8.9	10.3	11.5	12.6	13.6	14.6	15.5	16.3	17.1	17.9	19.3	21	23	28	
	6016	4.5	5.2	5.8	6.3	6.8	7.3	7.7	8.2	8.6	8.9	9.6	10.3	11.5	14.1	
	6031	8.7	10.0	11.2	12.2	13.2	14.1	15.0	15.8	16.6	17.3	18.7	16.1	22	27	
	6038	10.6	12.2	13.7	15.0	16.2	17.3	18.4	19.4	20	21	23	27	27	34	
80°	8003	0.84	0.97	1.1	1.2	1.3	1.4	1.45	1.5	1.6	1.7	1.8	1.9	2.2	2.6	
	8003	1.4	1.6	1.8	2.0	2.1	2.3	2.4	2.5	2.7	2.8	3.0	3.2	3.6	4.4	
	8011	3.1	3.5	4.0	4.3	4.7	5.0	5.3	5.6	5.9	6.1	6.6	7.1	7.9	9.7	
	8019	5.3	6.1	6.8	7.5	8.1	8.7	9.2	9.7	10.2	10.6	11.5	12.2	13.7	16.8	
	8030	8.4	9.7	10.8	11.8	12.8	13.7	14.5	15.3	16.0	16.7	18.1	19.3	22	26	
	8036	10.0	11.6	13.0	14.2	15.3	16.4	17.4	18.3	19.2	20	22	23	26	32	
	8046	12.8	14.8	16.6	18.2	19.6	21	22	23	25	26	28	30	33	41	
	100°	10011	3.1	3.5	4.0	4.3	4.7	5.0	5.3	5.6	5.9	6.1	6.6	7.1	7.9	9.7
10020		5.6	6.4	7.2	7.9	8.5	9.1	9.7	10.2	10.7	11.2	12.1	12.9	14.4	17.7	
120°	12008	2.2	2.6	2.9	3.2	3.4	3.6	3.9	4.1	4.3	4.5	4.8	5.2	5.8	7.1	
130°	13016	4.5	5.2	5.8	6.3	6.8	7.3	7.7	8.2	8.6	8.9	9.6	10.3	11.5	14.1	

L Series Paper and pulp Nozzle

155RS Metal Adjustable Spray Nozzle

155RS Metal Adjustable Global Spray Nozzle is made of 304#, 303#, 316# stainless steel or brass(Depending on customers requirement). With the connecting of globe and metal sprayhead, you can precisely adjust the spraying direction to keep it in best state. The spray head can be disassembled directly without tools. It is widely applied in auto show testin, such as shower testing line of Yantai General Motors bodywork Factory, Shuzhou Hangtian Automobile Factory, Wuhu Qurui Auto-mobile Factory an Beijing. Modern Automobile Factory.



155RS Series

	155RS Series	
Material	BRASS、S303(SUS303)material S316(SUS316),other	

Screw thread	Nozzle type	Screw on base	Screw on Spray tip	Size(mm)			Weight(gr.)	
				L	h ₁ / h ₂ (Subtense)	BRASS	SUS	
male	155RS	1/8	1/8	32	22	21	60	56
	155RS	1/4	1/4	36	22	21	65	60
	155RS	1/4	1/4	39	29	24	110	110
	155RS	3/8	3/8	40	29	24	115	105
	155RS	3/8	3/8	47	35	30	205	190
	155RS	1/2	1/2	54	41	41	350	325
	155RS	3/4	3/4	61	50	46	525	490
Female	155RS	1/8	1/8	28	22	21	69	63
	155RS	1/4	1/8	28	22	21	63	58
	155RS	1/4	1/4	33	29	24	120	110
	155RS	3/8	1/4	33	29	24	110	100
	155RS	3/8	3/8	44	35	30	235	220
	155RS	1/2	1/2	48	41	41	405	375
	155RS	3/4	3/4	55	50	46	600	560

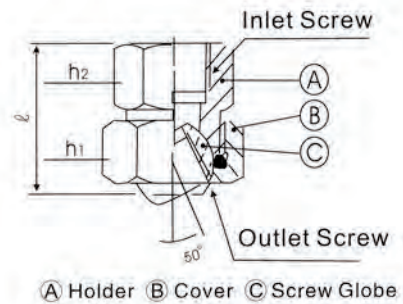
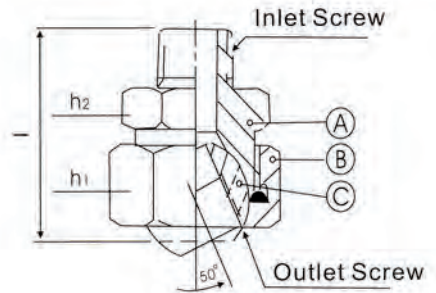

Nozzle specifications	Model
Selective;and you can check our catalogue for details (Common Metal Spray Nozzle)	Brass,SS

Ordering Information

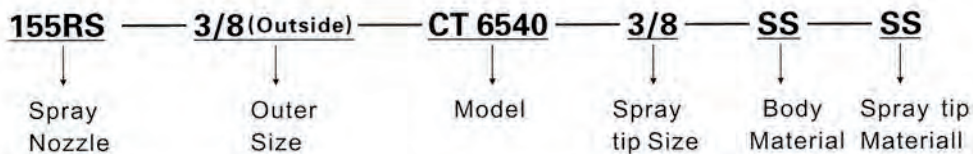

Metal Connectors

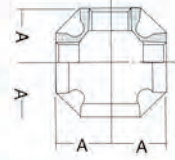

Screwed Nipple Spare Parts List

Dimension	A
6 ^A 1/8 ^B	
8 1/4	19
10 3/8	23
15 1/2	27
20 3/4	32
25 1	38

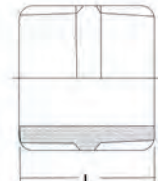

Dimension	L	Dimension	L
6 ^A 1/8 ^B	20	32 ^A 1/8 ^B	50
8 1/4	26	40 1/2	50
10 3/8	28	50 2	58
15 1/2	34	65 2 1/2	70
20 3/4	38	80 3	78
25 1	43	100 4	90

Dimension	H	C	Dimension	H	C
6 ^A 1/8 ^B	14	7	32 ^A 1 1/4 ^B	35	22
8 1/4	18	9	40 1 1/2	37	25
10 3/8	20.5	12	50 2	41	31
15 1/2	25	14	65 2 1/2	48	41
20 3/4	27	17	80 3	53	46
25 1	32	19	100 4	62	58

Dimension	A	Dimension	A
6 ^A 1/8 ^B	19	32 ^A 1 1/4 ^B	46
8 1/4	19	40 1 1/2	48
10 3/8	23	50 2	57
15 1/2	27		
20 3/4	32		
25 1	38		

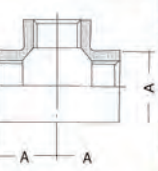
Dimension	D	L	Dimension	D	L
6 ^A 1/8 ^B	14	20	32 ^A 1 1/4 ^B	47	48
8 1/4	17	25	40 1 1/2	53	48
10 3/8	21	26	50 2	66	56
15 1/2	25	34	65 2 1/2	82	65
20 3/4	31	36	80 3	95	71
25 1	38	43	100 4	121	83

Dimension	A	Dimension	A
6 ^A 1/8 ^B	19	32 ^A 1 1/4 ^B	46
8 1/4	19	40 1 1/2	48
10 3/8	23	50 2	57
15 1/2	27		
20 3/4	32		
25 1	3/8		

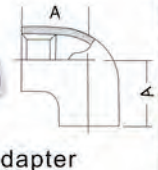

Dimension	C	L	Nut	Dimension	C	L	Nut
6 ^A 1/8	17	30	26(hexagonal)	32 ^A 1 1/4 ^B	50	56	69(10角)
8 1/4	20	34	32(octagonal)	40 1 1/2	56	60	78(10角)
10 3/8	25.5	37	38(octagonal)	50 2	69	67	93(10角)
15 1/2	29	40	41(octagonal)	65 2 1/2	86	84	112(10角)
20 3/4	33	48.5	50(octagonal)	80 3	99	92	127(10角)
25 1	41	52	59(decagonal)				

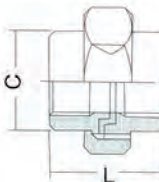
Dimension	C	L	E2	D	d	ExNo.	Dimension	C	L	E2	D	d	Ex数
6 ^A 1/8 ^B							32 ^A 1 1/4 ^B						
8 1/4	14	39	20	8	5	4x4	40 1 1/2	43	94	60	34	25	10x4
10 3/8	17	45	25	10.5	8	5x4	50 2	49	97	60	40.5	31	10x4
15 1/2	22	53	30	14	11	6x4		61	110	69	52.5	42	10x4
20 3/4	27	67	40	20	16	8x4							
25 1	34	81	50	26.5	22	10x4							

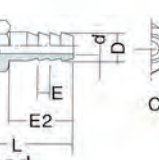

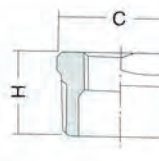

Dimension	C	H	Minor diameter size	Dimension	C	H	Minor diameter size
6 ^A 1/8 ^B				32 ^A 1 1/4 ^B	43	30	2.5 ^A . 20 ^A . 15 ^A
8 1/4	14	17	6 ^A	40 1 1/2	49	32	32 ^A . 25 ^A . 20 ^A . 15 ^A
10 3/8	17	18	8 ^A . 6 ^A	50 2	61	36	40 ^A . 32 ^A . 25 ^A . 20 ^A
15 1/2	22	21	10 ^A . 8 ^A . 6 ^A	65 2 1/2	80	39	50 ^A . 40 ^A
20 3/4	27	24	15 ^A . 10 ^A . 8 ^A	80 3	95	44	65 ^A . 50 ^A . 40 ^A
25 1	34	27	20 ^A . 15 ^A . 10 ^A . 8 ^A	100 4	120	51	80 ^A . 65 ^A . 50 ^A . 40 ^A



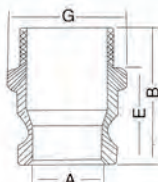

Dimension	C	L	E	Dimension	C	L	E
6 ^A 1/8 ^B	12	28	10	32 ^A 1 1/4 ^B	43	56	22
8 1/4	14	34	12	40 1 1/2	49	60	23
10 3/8	17	36	13	50 2	61	66	25
15 1/2	22	42	16	65 2 1/2	80	73	28
20 3/4	27	47	18	80 3	95	81	32
25 1	34	52	20	100 4	120	92	37

N Series Nozzle pipe Line Accessories

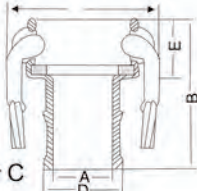
 Quick-install adapter F		DIM	1/2	3/4	1	1-1/4	1-1/2	2	2-1/2	3	4	5	6
		A	21	21	34	28.5	36	45	56.5	73	98	122	148
		B	56	56	72	80	84	88	100	106	114	121	130
		C	32	32	40	48	56	67	83	96	127	154	190
		E	38	38	48	56	60	62	69	73	78	81	86

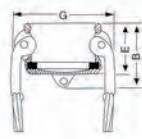
 Quick-install adapter C		DIM	1/2	3/4	1	1-1/4	1-1/2	2	2-1/2	3	4	5	6
		A	14	14	20	25	31	43	55	67	92	115	140
		B	92	92	105	118	121	138	155	164	175	187	214
		D	20	20	26	33	39	52	65	77	103	130	155
		E	32	32	40	48	49	54	59	60	62	62	72
		G	53	54	61	79	83	94	109	130	158	184	219

 Quick-install adapter DC		DIM	3/4	1	1-1/4	1-1/2	2	2-1/2	3	4	5	6	
		B	45	45	54	65	69	78	83	88	94	94	112
		E	35	35	42	51	52	59	64	65	70	70	82
		G	53	54	61	79	83	94	109	130	158	184	219

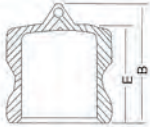
 Quick-install adapter DP		DIM	1/2	3/4	1	1-1/4	1-1/2	2	2-1/2	3	4	5	6
		B	37	37	44	55	64	68	70	80	80	80	98
		E	26	25	32	41	44	48	50	57	56	56	66

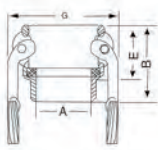
 Quick-install adapter B		DIM	1/2	3/4	1	1-1/4	1-1/2	2	2-1/2	3	4	5	6
		A	14	19	24	28	35	48	58	72	98	122	145
		B	52	52	64	72	73	80	90	94	101	102	118
		E	32	32	40	48	49	54	59	60	62	62	72
		G	53	54	61	79	83	94	109	130	158	184	219

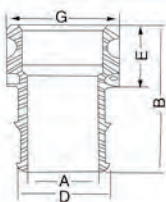
 Quick-install adapter E		DIM	1/2	3/4	1	1-1/4	1-1/2	2	2-1/2	3	4	5	6
		A	14	14	20	25	31	43	55	67	92	115	140
		B	98	98	110	121	125	140	158	170	182	196	220
		C	33	33	39	48	56	66	80	102	132	154	184
		D	20	20	26	33	39	52	65	77	102	130	155
		E	40	40	46	53	56	60	64	66	69	71	78

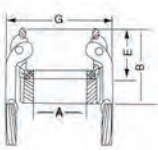
 Quick-install adapter D		DIM	1/2	3/4	1	1-1/4	1-1/2	2	2-1/2	3	4	5	6
		A	16	19	26	33	39	50	61	75	92	122	145
		B	52	52	62	68	71	78	85	90	96	102	118
		E	32	32	40	48	49	54	59	60	62	62	72
		G	53	41	61	79	83	94	109	130	158	184	219

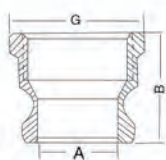
 Quick-install adapter A		DIM	1/2	3/4	1	1-1/4	1-1/2	2	2-1/2	3	4	5	6
		A	16	21	24	28.5	36	45	56.5	73	98	122	150
		B	38	38	48	56	60	64	87	73	78	95	86
C	32	32	40	48	56	67	83	96	127	154	190		

Solenoid Valves

piloted two-way type

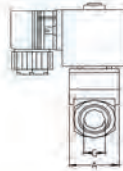
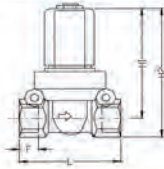

Path	Female inlet connection	External Dimensions					
		DN	G	L	H1	H2	A
4-8	1/4						
10	3/8	70	75	65	97	16	
15	1/2						
20	3/4	91	96	117	56	16	
25	1	115	98	122	71	22	

direct-acting two-position and 3-way type

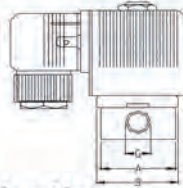

Path	Female inlet connection	External Dimensions						
		DN	G	L1	L2	H	A	B
1				25		56	20	
2	1/8-1/4			32	34	67	32	34
				25	56			20
3	1/4			32	34			
				46	48	67	32	34
4								
5								

standard specification

Model	Dimension	Female (BSPT) Thread	Body material	Sealing material	Valve action model	Maximum pressure bar	Orifice size
Two-way type	CY-2CF-1/8	1/8	Brass or stainless steel	nitrile rubber or fluorizate rubber	Direct-acting	16	2
	CY-2CF-1/4	1/4				6	5
	CY-2CF-3/8	3/8			pilote type	10	10
	CY-2CF-1/2	1/2				16	20
	CY-2CF-3/4	3/4				16	25
CY-2CF-1	1	Direct-acting	16	1			
CY-3CF-1/8	1/8		16	3			
3-way type	CY-3CF-1/4	1/4					

Product application

Electromagnetic valve is used for automatic operation system which requires switch flowing. It is widely used in the corollary equipment of air compressor, bottle blowing machine, fire safety, stage equipment, Food processor, cleaning equipment, ordnance equipment, petrochemical equipment, machinofacture as well as other autocontrol equipment of related industry.

Design Features

Electromagnetic valve, with a structure of piston, is durable, having a compact and fine design. It is also low-temperature and noiseless, leakless, gleg and high frequency. As the medium has impurities, the filter should be install in front of the valve, (mesh 82mesh/m2). then it would not solidify and crystallize. The piston is usually close. Between 5 oC to90 oC, it can be safely used in air and liquid channel. The material of the valve can be stainless steel and brass. The sealing element can be nitrile rubber or fluorizate rubber. The action model can be direct-acting, multiple step acting and pilote type. The connection type can be two-way type and two-position-and-three-way type

Choosing requirements

If you haven't decide the model, please offer relative parameter for us, like inside nominal diameter, tpe of medium, operating pressure, voltage rating connection style, installation way, medium temperature, environmental temperature, valve material, and other specific function such as normal open or normal close, signal feedback or non-return, hand priming device, viscosity and corrosivity of the medium.

Choosing considerations

- 一、 According to the parameter of channel: DN and way of connection
 - ▲ with reference to the diameter and the flow rate of the practical channel to decide DN
 - ▲ normally choosing flanged joint when it is lager than DN50, otherwise it can be freely chosen by customers.
- 二、 According to the parameter of fluid: material and temperature group.
 - ▲ corrosive fluid: choosing corrosive magnatic valve and that of fully-made by stailless steel. Edible superclean fluid: choosing magnatic valve made by edible grade stailless steel
 - ▲ high-temperature fluid: choosing the piston-type magnatic valve made by high temperature resistance material and sealing material
 - ▲ fluid state: normally has gaseity, liquid and mixed state, please distinguishing when you order
 - ▲ fluid viscosity: usually can be randomly chosen the the viscosity is below 50ost, otherwise you shoud choose high viscosity magnatic valve.
- 三、 According to the parameter of pressure: principle and structure
 - ▲ nominal pressure :this parameter is the same as other definition of common valve which is set by the nominal pressure of the channel.
 - ▲ operating pressure: if it is low, then you must choose direct-acting or multiple step acting type. When the differential pressure is more than 0.04mpa, all types can be used.
- 四、 Electric chosen: voltage specification should be AC220V or DC24 which is more convenient.
- 五、 According to the length of working hours: normal close, nomal open or sustainable electrified.
 - ▲ when the magnatic valve should be opened for a long time and seldome closed, normal open type should be chosen.
 - ▲ if the duration is short and not opened frequently, normal close type should be chosen.
 - ▲ sometime when it is used for safeguards, like monitoring the stove and fire, then it can be chosen as nomal open type, but the long term current carrying type.

Liquid Filter

To1-PP



Polypropylene strainer body and strainer head, 10 bar, 1/2 inch-3/4 inch NPT or BSPT(inner)

To2-PC



Polycarbonate strainer body and Polypropylene strainer head, 10 bar, 1/2 inch-3/4 inch NPT or BSPT(inner)

Liquid filter

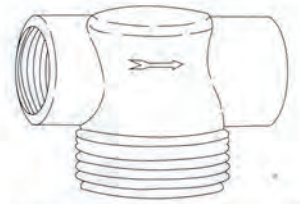

Polypropylene filter head



The framework of polypropylene with stainless steel mesh filter with a variety of sizes



Second propylene rubber Seal circle

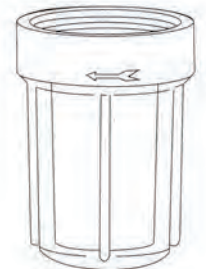

Polypropylene strainer body

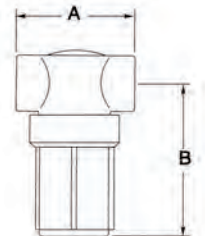

Design features

To1 type water filter ideal for small container under medium pressure .

To1-PP type has polypropylene strainer body and strainer head, so it's unattackable and chemical resistant

Both of their strainer body can be taken down by hand. The size of their strainer are various.

The maximum pressure of 1/2 type strainers is 10 bar. They have inlet connection whose size is 1/2 inch or 3/4 inch NPT or BSPT(inner).

To2-PC type has polypropylene strainer head and transparent polycarbonate strainer body which is resistant to ultraviolet radiation, so that it's convenient to check-up inner strainer by eye.

Strainer porthole	
Mesh size	Porthole size
16	1.1mm
30	0.53mm
50	0.28mm
80	0.18mm
100	0.15mm
200	0.08mm

Dimension and weight

Strainer type	Inlet joint NPT or BSPT (female)	Crust material	Strainer				Size		Net Weight (KG)	Approximate flow rate when the pressure is reduced by 0.35 bar	
			Single strength mesh	Strainer	Total area	Open space		A (mm)			B (mm)
						Main-cm	By intake acreage				
To1-1/2-PP	1/2	Polypropylene	16	16nets-1-304SS	49.7	25	13	79	92	0.1	
			30	30nets-2-304SS		20	10.5				
			50	50nets-3-304SS		15	7.7				
To2-1/2-PC		Polycarbonate	80	80nets-4-304SS		15.5	8.0				
			100	100nets-5-304SS		15.4	8.0				
			200	200nets-7-304SS		16.4	8.5				
To1-3/4-PP	3/4	Polypropylene	16	16nets-1-304SS	49.7	25	13	79	92	0.1	
			30	30nets-2-304SS		20	10.5				
			50	50nets-3-304SS		15	7.7				
To2-3/4-PC		Polycarbonate	80	80nets-4-304SS		15.5	8.0				
			100	100nets-5-304SS		15.4	8.0				
			200	200nets-7-304SS		16.4	8.5				

Ordering info

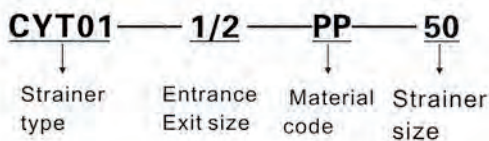

Y Shape Liquid Strainer

Y shape thread-connection



Y shape flanged connection



product features

The strainer inside is made of stainless steel which is double decked, it is very durable. It also has the features of advanced structure, large flow area, small flow resistance, easy blowdown and soon. It can be used in water, steam, oil, nitric acid and other corrosive liquids. Our clients can set the mesh number according to their requirement. Normoally, the mesh number of hydrographic net is 18-30, and that of aeration net is 100-480. It is one of the necessary device which are used for conveying fluid. It is usually installed in the entrance end of hydraulic control valve, reducing valve, relief valve, definite-level valve and so on, which is used to remove the impurities from the medium and prevent the particulate medium from entering and blocking the channel. So it can keep the parts that are in the channel not being worn away and jammed.

Application range

It is applied to steam, air, water, oil and other duct system, protecting various devices such as metrologic instrument, pump, valve and all kinds of spray nozzles. When washing it, it is easy and convenient that take the withdrawable filter cartridge out, cleaning the medium on it, and reinstalling it again.

technical parameter

Hard surface material	Brass/SS	Way of connection	Threads, Flange
frame and mesh material	Stainless steel	nominal pressure(Mpa)	0.6~5.0
sealing element material	flexible graphite, polyfluortetraethylene	filter fineness(mesh/in)	10~300
environmental temperature	-30~400		

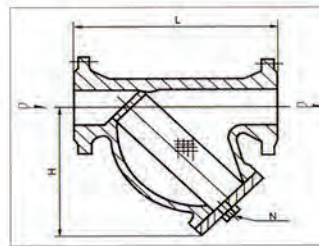
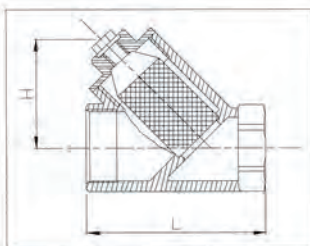

Dimension

Inside nominal diameter	Screw threads	Dimension L	Dimension H
6	1/4	63.5	42
10	3/8	64	42
15	1/2	65	43
20	3/4	80	50
25	1	89	60
32	1-1/4	107	64
40	1-1/2	118	70
50	2	140	88
65	Flange 2-1/2 inch	260	165
80	Flange 3 inch	280	195
100	Flange 4 inch	320	230
125	Flange 5 inch	350	300
150	Flange 6inch	380	335

Ordering info

Y1/2 — **SS** — **30**

↓ ↓ ↓
 Model and Materials Mesh
 thread number
 connection size

Pressure Gauge

Common type



Stainless steel aseismatic type



Design Features

This watch joint and its accessory which contact liquid are all made of brass, it use for test copper and copper-alloy non-caustic, non-volatile, non-crystal, non-deposit gas or liquid pressure. This watch when it is working, it work place should plumb installation, loading steady, plus or minus loading should even, surrounding environment temperature is 20 ± 5 C. (if use temperature departure 20 ± 5 C. the temperature error less than $0.4\% 10^{\circ}\text{C}$)

Model	Outer dia	Measuring range	Accuracy grade	Join t thread
Y40	φ 40	0.6,1,1.6,2.5,4,6	2.5	M10x1
Y60	φ 60	0.6,1,1.6,2.5,4	2.5	M10X1或M14x1.5
Y100	φ 100		1.6	M20x1.5
Y150	φ 150	6,10,16,25,40	1.6	M20x1.5
Y200	φ 200	60,100	1.6	M20x1.5
Y250	φ 250		1.6	M20x1.5

Design Features

This watch was close structures and the housing was whole stainless steel, it efficient protect the inner accessory avoid the environment effect and dirtiness inrush, for the watch which fill liquid (As, silicon oil and glycerin) in the housing, it can resist the work environment shake and reduce the pulsant impact of medium pressure. It is extensive use for industry department of oil, chemical industry, chemical fiber, metallurgy, electricity station etc. it is aim at endure erodent, aseismatic -those special craftwork process measure the pressure of all kinds of liquid material.

Model	Outer dia	Measuring range	Accuracy grade	Join thread
Y60	φ 60	0.6,1,1.6,2.5,4	2.5	M10x1 or G1/4
Y100	φ 100	6,10,16,25,40	1.6	M20X1.5 or G1/2
Y150	φ 150	60	1.6	M20x1.5 or G1/2

