

Fire Fighting Equipment





2KG WN01-01



外 径	(Out-diameter): Φ 111mm
容 积	(Volume): 3L
瓶 高	(Cylinder Length): 445mm
瓶 重	(Cylinder Weight): 2.3Kg
灭火器重量	(Extinguisher Weight): 5Kg
灭火剂重量	(Filling Weight): 2Kg
温度范围	(Temperature Range): -30 $^{\circ}$ C-60 $^{\circ}$ C
最大工作压力	(Max Working Pressure): 150Bar
测试压力	(Test Pressure): 215Bar
最小壁厚	(Min Wall-thickness): 4.4mm
材 料	(Material): AA6061
灭火级别	(Fire Class): 34B
包装尺寸	(Packing Size): 16X13X56.5cm



5KG WN01-02



外 径	(Out-diameter): Φ 152mm
容 积	(Volume): 7.5L
瓶 高	(Cylinder Length): 575mm
瓶 重	(Cylinder Weight): 5.5Kg
灭火器重量	(Extinguisher Weight): 11Kg
灭火剂重量	(Filling Weight): 5Kg
温度范围	(Temperature Range): -30 $^{\circ}$ C-60 $^{\circ}$ C
最大工作压力	(Max Working Pressure): 150Bar
测试压力	(Test Pressure): 215Bar
最小壁厚	(Min Wall-thickness): 6.02mm
材 料	(Material): AA6061
灭火级别	(Fire Class): 89B
包装尺寸	(Packing Size): 21X17X69.5cm

2KG WN08-03



外 径	(Out-diameter): Φ 111mm
容 积	(Volume): 2.67L
瓶 高	(Cylinder Length): 430mm
瓶 重	(Cylinder Weight): 3Kg
灭火器重量	(Extinguisher Weight): 6Kg
灭火剂重量	(Filling Weight): 2Kg
温度范围	(Temperature Range): -30°C-60°C
最大工作压力	(Max Working Pressure): 216Bar
测试压力	(Test Pressure): 315Bar
最小壁厚	(Min Wall-thickness): 8.61mm
材 料	(Material): AA6061
灭火级别	(Fire Class): 34B
包装尺寸	(Packing Size): 16X13X55cm



5KG WN08-04



外 径	(Out-diameter): Φ 159mm
容 积	(Volume): 6.67L
瓶 高	(Cylinder Length): 535mm
瓶 重	(Cylinder Weight): 8Kg
灭火器重量	(Extinguisher Weight): 14Kg
灭火剂重量	(Filling Weight): 5Kg
温度范围	(Temperature Range): -30°C-60°C
最大工作压力	(Max Working Pressure): 216Bar
测试压力	(Test Pressure): 315Bar
最小壁厚	(Min Wall-thickness): 9.46mm
材 料	(Material): AA6061
灭火级别	(Fire Class): 89B
包装尺寸	(Packing Size): 22X17X65.5cm



2KG WN01-03



外 径	(Out-diameter): $\Phi 111\text{mm}$
容 积	(Volume): 3L
瓶 高	(Cylinder Length): 475mm
瓶 重	(Cylinder Weight): 3.2Kg
灭火器重量	(Extinguisher Weight): 6Kg
灭火剂重量	(Filling Weight): 2Kg
温度范围	(Temperature Range): $-30^{\circ}\text{C}-60^{\circ}\text{C}$
最大工作压力	(Max Working Pressure): 174Bar
测试压力	(Test Pressure): 250Bar
最小壁厚	(Min Wall-thickness): 6.32mm
材 料	(Material): AA6061
灭火级别	(Fire Class): 34B
包装尺寸	(Packing Size): 16X13X59.5cm



5KG WN01-04



外 径	(Out-diameter): $\Phi 159\text{mm}$
容 积	(Volume): 7.5L
瓶 高	(Cylinder Length): 580mm
瓶 重	(Cylinder Weight): 8Kg
灭火器重量	(Extinguisher Weight): 14Kg
灭火剂重量	(Filling Weight): 5Kg
温度范围	(Temperature Range): $-30^{\circ}\text{C}-60^{\circ}\text{C}$
最大工作压力	(Max Working Pressure): 174Bar
测试压力	(Test Pressure): 250Bar
最小壁厚	(Min Wall-thickness): 9.05mm
材 料	(Material): AA6061
灭火级别	(Fire Class): 89B
包装尺寸	(Packing Size): 22X17X70cm





2KG WN02-01



外 径	(Out-diameter):	Φ 105mm
容 积	(Volume):	3L
瓶 高	(Cylinder Length):	475mm
瓶 重	(Cylinder Weight):	4.2Kg
灭火器重量	(Extinguisher Weight):	7Kg
灭火剂重量	(Filling Weight):	2Kg
温度范围	(Temperature Range):	-30℃-60℃
最大工作压力	(Max Working Pressure):	174Bar
测试压力	(Test Pressure):	250Bar
最小壁厚	(Min Wall-thickness):	2.3mm
材 料	(Material):	34CrMo4
灭火级别	(Fire Class):	34B
包装尺寸	(Packing Size):	16X13X60cm



5KG WN02-02



外 径	(Out-diameter):	Φ 138mm
容 积	(Volume):	7.5L
瓶 高	(Cylinder Length):	655mm
瓶 重	(Cylinder Weight):	8.5Kg
灭火器重量	(Extinguisher Weight):	14Kg
灭火剂重量	(Filling Weight):	5Kg
温度范围	(Temperature Range):	-30℃-60℃
最大工作压力	(Max Working Pressure):	174Bar
测试压力	(Test Pressure):	250Bar
最小壁厚	(Min Wall-thickness):	3mm
材 料	(Material):	34CrMo4
灭火级别	(Fire Class):	89B
包装尺寸	(Packing Size):	21X15X78cm

1KG WN03-01



外 径	(Out-diameter): Φ 85mm
容 积	(Volume): 1.25L
瓶 高	(Cylinder Length): 270mm
瓶 重	(Cylinder Weight): 0.7Kg
灭火器重量	(Extinguisher Weight): 2.2Kg
灭火剂重量	(Dry Powder Filled Weight): 1Kg
温 度 范 围	(Temperature Range): -30°C-60°C
最大工作压力	(Max Working Pressure): 18Bar
测试压力	(Test Pressure): 27Bar
最小壁厚	(Min Wall-thickness): 1.0mm
材 料	(Material): St12/DC01
灭 火 级 别	(Fire Class): 5A 34B C
包 装 尺 寸	(Packing Size): 10X10X36cm



2KG WN03-02



外 径	(Out-diameter): Φ 110mm
容 积	(Volume): 2.5L
瓶 高	(Cylinder Length): 310mm
瓶 重	(Cylinder Weight): 1.1Kg
灭火器重量	(Extinguisher Weight): 3.7Kg
灭火剂重量	(Dry Powder Filled Weight): 2Kg
温 度 范 围	(Temperature Range): -30°C-60°C
最大工作压力	(Max Working Pressure): 18Bar
测试压力	(Test Pressure): 27Bar
最小壁厚	(Min Wall-thickness): 1.07mm
材 料	(Material): St12/DC01
灭 火 级 别	(Fire Class): 13A 70B C
包 装 尺 寸	(Packing Size): 12X13X40cm



6KG WN03-03



外 径	(Out-diameter): Φ 160mm
容 积	(Volume): 7.9L
瓶 高	(Cylinder Length): 450mm
瓶 重	(Cylinder Weight): 2.8Kg
灭火器重量	(Extinguisher Weight): 9.5Kg
灭火剂重量	(Dry Powder Filled Weight): 6Kg
温 度 范 围	(Temperature Range): -30°C-60°C
最大工作压力	(Max Working Pressure): 18Bar
测试压力	(Test Pressure): 27Bar
最小壁厚	(Min Wall-thickness): 1.24mm
材 料	(Material): St12/DC01
灭 火 级 别	(Fire Class): 27A 183B C
包 装 尺 寸	(Packing Size): 17X18X56cm





9KG WN03-04



外 径	(Out-diameter):	Φ180mm
容 积	(Volume):	11.4L
瓶 高	(Cylinder Length):	510mm
瓶 重	(Cylinder Weight):	4.3Kg
灭火器重量	(Extinguisher Weight):	14Kg
灭火剂重量	(Dry Powder Filled Weight):	9Kg
温度范围	(Temperature Range):	-30℃-60℃
最大工作压力	(Max Working Pressure):	18Bar
测试压力	(Test Pressure):	27Bar
最小壁厚	(Min Wall-thickness):	1.30mm
材 料	(Material):	St12/DC01
灭火级别	(Fire Class):	34A 233B C
包装尺寸	(Packing Size):	19X20X62cm



12KG WN03-05



外 径	(Out-diameter):	Φ180mm
容 积	(Volume):	13.6L
瓶 高	(Cylinder Length):	600mm
瓶 重	(Cylinder Weight):	5Kg
灭火器重量	(Extinguisher Weight):	18Kg
灭火剂重量	(Dry Powder Filled Weight):	12Kg
温度范围	(Temperature Range):	-30℃-60℃
最大工作压力	(Max Working Pressure):	18Bar
测试压力	(Test Pressure):	27Bar
最小壁厚	(Min Wall-thickness):	1.30mm
材 料	(Material):	St12/DC01
灭火级别	(Fire Class):	43A 233B C
包装尺寸	(Packing Size):	19X20X71cm

干粉灭火器(内置) DRY POWDER FIRE EXTINGUISHER
(WITH INTERNAL GAS CARTRIDGE)

6KG WN04-01



外 径	(Out-diameter): Φ 160mm
容 积	(Volume): 7.9L
瓶 高	(Cylinder Length): 455mm
瓶 重	(Cylinder Weight): 3Kg
灭火器重量	(Extinguisher Weight): 11Kg
灭火剂重量	(Dry Powder Filled Weight): 6Kg
温 度 范 围	(Temperature Range): -30°C – 60°C
测 试 压 力	(Test Pressure): 27Bar
最 小 壁 厚	(Min Wall-thickness): 1.24mm
材 料	(Material): St12/DC01
灭 火 级 别	(Fire Class): 27A 183B C
包 装 尺 寸	(Packing Size): 17X18X57cm

内 置 小 钢 瓶	(Internal gas cartridge)
驱 动 气 体	(Drive gas): CO ₂ (120)g
材 料	(Material): St52



清水灭火器 WATER FIRE EXTINGUISHER

9L WN05-01



外 径	(Out-diameter): Φ 180mm
容 积	(Volume): 11.3L
瓶 高	(Cylinder Length): 525mm
瓶 重	(Cylinder Weight): 4.6Kg
灭火器重量	(Extinguisher Weight): 14.5Kg
灭火剂重量	(Filling Weight): 9L
温 度 范 围	(Temperature Range): 5°C – 60°C
最 大 工 作 压 力	(Max Working Pressure): 18Bar
测 试 压 力	(Test Pressure): 27Bar
最 小 壁 厚	(Min Wall-thickness): 1.30mm
材 料	(Material): St12/DC01
灭 火 级 别	(Fire Class): 21A
包 装 尺 寸	(Packing Size): 19X20X64cm





2L WN06-01



外 径	(Out-diameter):	Φ 110mm
容 积	(Volume):	2.4L
瓶 高	(Cylinder Length):	310mm
瓶 重	(Cylinder Weight):	1.4Kg
灭火器重量	(Extinguisher Weight):	4Kg
灭火剂重量	(Filling Weight):	2L
温 度 范 围	(Temperature Range):	0℃-60℃
最大工作压力	(Max Working Pressure):	18Bar
测 试 压 力	(Test Pressure):	27Bar
最 小 壁 厚	(Min Wall-thickness):	1.08mm
材 料	(Material):	St12/DC01
灭 火 级 别	(Fire Class):	8A 34B C
包 装 尺 寸	(Packing Size):	12X13X40cm



6L WN06-02



外 径	(Out-diameter):	Φ 160mm
容 积	(Volume):	8L
瓶 高	(Cylinder Length):	470mm
瓶 重	(Cylinder Weight):	3.3Kg
灭火器重量	(Extinguisher Weight):	10Kg
灭火剂重量	(Filling Weight):	6L
温 度 范 围	(Temperature Range):	0℃-60℃
最大工作压力	(Max Working Pressure):	18Bar
测 试 压 力	(Test Pressure):	27Bar
最 小 壁 厚	(Min Wall-thickness):	1.24mm
材 料	(Material):	St12/DC01
灭 火 级 别	(Fire Class):	21A 144B C
包 装 尺 寸	(Packing Size):	17X18X58cm



9L WN06-03



外 径	(Out-diameter):	Φ 180mm
容 积	(Volume):	11.3L
瓶 高	(Cylinder Length):	525mm
瓶 重	(Cylinder Weight):	4.6Kg
灭火器重量	(Extinguisher Weight):	14Kg
灭火剂重量	(Filling Weight):	9L
温 度 范 围	(Temperature Range):	0℃-60℃
最大工作压力	(Max Working Pressure):	18Bar
测 试 压 力	(Test Pressure):	27Bar
最 小 壁 厚	(Min Wall-thickness):	1.30mm
材 料	(Material):	St12/DC01
灭 火 级 别	(Fire Class):	21A 183B C
包 装 尺 寸	(Packing Size):	19X20X64cm

2KG WN07-01



外 径	(Out-diameter): Φ 111mm
容 积	(Volume): 3L
瓶 高	(Cylinder Length): 445mm
瓶 重	(Cylinder Weight): 2.3Kg
灭火器重量	(Extinguisher Weight): 5Kg
灭火剂重量	(Filling Weight): 2Kg
温 度 范 围	(Temperature Range): -30°C-60°C
最大工作压力	(Max Working Pressure): 150Bar
测试压力	(Test Pressure): 215Bar
最小壁厚	(Min Wall-thickness): 4.4mm
材 料	(Material): AA6061
灭火级别	(Fire Class): 34B
包装尺寸	(Packing Size): 16X13X56.5cm



5KG WN07-02



外 径	(Out-diameter): Φ 152mm
容 积	(Volume): 7.5L
瓶 高	(Cylinder Length): 575mm
瓶 重	(Cylinder Weight): 5.5Kg
灭火器重量	(Extinguisher Weight): 12Kg
灭火剂重量	(Filling Weight): 5Kg
温 度 范 围	(Temperature Range): -30°C-60°C
最大工作压力	(Max Working Pressure): 150Bar
测试压力	(Test Pressure): 215Bar
最小壁厚	(Min Wall-thickness): 6.02mm
材 料	(Material): AA6061
灭火级别	(Fire Class): 89B
包装尺寸	(Packing Size): 21X17X69.5cm





2KG WN08-01



外 径	(Out-diameter): Φ 111mm
容 积	(Volume): 3L
瓶 高	(Cylinder Length): 475mm
瓶 重	(Cylinder Weight): 3.2Kg
灭火器重量	(Extinguisher Weight): 6Kg
灭火剂重量	(Filling Weight): 2Kg
温度范围	(Temperature Range): -20°C-60°C
最大工作压力	(Max Working Pressure): 174Bar
测试压力	(Test Pressure): 250Bar
最小壁厚	(Min Wall-thickness): 6.32mm
材 料	(Material): AA6061
灭火级别	(Fire Class): 34B
包装尺寸	(Packing Size): 16X13X59.5cm



5KG WN08-02



外 径	(Out-diameter): Φ 159mm
容 积	(Volume): 7.5L
瓶 高	(Cylinder Length): 580mm
瓶 重	(Cylinder Weight): 8Kg
灭火器重量	(Extinguisher Weight): 14Kg
灭火剂重量	(Filling Weight): 5Kg
温度范围	(Temperature Range): -20°C-60°C
最大工作压力	(Max Working Pressure): 174Bar
测试压力	(Test Pressure): 250Bar
最小壁厚	(Min Wall-thickness): 9.05mm
材 料	(Material): AA6061
灭火级别	(Fire Class): 89B
包装尺寸	(Packing Size): 22X17X70cm



1.3KG WN09-01 CE0036

外 径	(Out-diameter): Φ 105mm
容 积	(Volume): 2L
瓶 高	(Cylinder Length): 355mm
瓶 重	(Cylinder Weight): 3.4Kg
灭火器重量	(Extinguisher Weight): 5.4Kg
灭火剂重量	(Filling Weight): 1.3Kg
温度范围	(Temperature Range): -20°C-60°C
最大工作压力	(Max Working Pressure): 174Bar
测试压力	(Test Pressure): 250Bar
最小壁厚	(Min Wall-thickness): 2.3mm
材 料	(Material): 34CrMo4
灭火级别	(Fire Class): 21B
包装尺寸	(Packing Size): 16X13X48cm



2KG WN09-02 CE0036

外 径	(Out-diameter): Φ 105mm
容 积	(Volume): 3L
瓶 高	(Cylinder Length): 475mm
瓶 重	(Cylinder Weight): 4.3Kg
灭火器重量	(Extinguisher Weight): 7Kg
灭火剂重量	(Filling Weight): 2Kg
温度范围	(Temperature Range): -20°C-60°C
最大工作压力	(Max Working Pressure): 174Bar
测试压力	(Test Pressure): 250Bar
最小壁厚	(Min Wall-thickness): 2.3mm
材 料	(Material): 34CrMo4
灭火级别	(Fire Class): 34B
包装尺寸	(Packing Size): 16X13X60cm

2.3KG WN09-03 CE0036

外 径	(Out-diameter): Φ 105mm
容 积	(Volume): 3.5L
瓶 高	(Cylinder Length): 530mm
瓶 重	(Cylinder Weight): 5Kg
灭火器重量	(Extinguisher Weight): 8Kg
灭火剂重量	(Filling Weight): 2.3Kg
温 度 范 围	(Temperature Range): -20°C-60°C
最大工作压力	(Max Working Pressure): 174Bar
测 试 压 力	(Test Pressure): 250Bar
最 小 壁 厚	(Min Wall-thickness): 2.3mm
材 料	(Material): 34CrMo4
灭 火 级 别	(Fire Class): 34B
包 装 尺 寸	(Packing Size): 16X13X65cm



3KG WN09-04 CE0036

外 径	(Out-diameter): Φ 138mm
容 积	(Volume): 4.5L
瓶 高	(Cylinder Length): 440mm
瓶 重	(Cylinder Weight): 7Kg
灭火器重量	(Extinguisher Weight): 11Kg
灭火剂重量	(Filling Weight): 3Kg
温 度 范 围	(Temperature Range): -20°C-60°C
最大工作压力	(Max Working Pressure): 174Bar
测 试 压 力	(Test Pressure): 250Bar
最 小 壁 厚	(Min Wall-thickness): 3mm
材 料	(Material): 34CrMo4
灭 火 级 别	(Fire Class): 34B
包 装 尺 寸	(Packing Size): 21X15X56cm



4KG WN09-05 CE0036

外 径	(Out-diameter): Φ 138mm
容 积	(Volume): 6L
瓶 高	(Cylinder Length): 550mm
瓶 重	(Cylinder Weight): 8Kg
灭火器重量	(Extinguisher Weight): 13Kg
灭火剂重量	(Filling Weight): 4Kg
温 度 范 围	(Temperature Range): -20°C-60°C
最大工作压力	(Max Working Pressure): 174Bar
测 试 压 力	(Test Pressure): 250Bar
最 小 壁 厚	(Min Wall-thickness): 3mm
材 料	(Material): 34CrMo4
灭 火 级 别	(Fire Class): 70B
包 装 尺 寸	(Packing Size): 21X15X67cm





4.5KG WN09-06 CE0036

外 径	(Out-diameter): Φ 138mm
容 积	(Volume): 6.8L
瓶 高	(Cylinder Length): 600mm
瓶 重	(Cylinder Weight): 8Kg
灭火器重量	(Extinguisher Weight): 14Kg
灭火剂重量	(Filling Weight): 4.5Kg
温度范围	(Temperature Range): -20°C-60°C
最大工作压力	(Max Working Pressure): 174Bar
测试压力	(Test Pressure): 250Bar
最小壁厚	(Min Wall-thickness): 3mm
材 料	(Material): 34CrMo4
灭火级别	(Fire Class): 70B
包装尺寸	(Packing Size): 21X15X73cm



5KG WN09-07 CE0036

外 径	(Out-diameter): Φ 138mm
容 积	(Volume): 7.5L
瓶 高	(Cylinder Length): 655mm
瓶 重	(Cylinder Weight): 8.6Kg
灭火器重量	(Extinguisher Weight): 15Kg
灭火剂重量	(Filling Weight): 5Kg
温度范围	(Temperature Range): -20°C-60°C
最大工作压力	(Max Working Pressure): 174Bar
测试压力	(Test Pressure): 250Bar
最小壁厚	(Min Wall-thickness): 3mm
材 料	(Material): 34CrMo4
灭火级别	(Fire Class): 89B
包装尺寸	(Packing Size): 21X15X78cm

2KG WN09-08



外 径	(Out-diameter): Φ 105mm
容 积	(Volume): 2.67L
瓶 高	(Cylinder Length): 440mm
瓶 重	(Cylinder Weight): 3.8Kg
灭火器重量	(Extinguisher Weight): 6.6Kg
灭火剂重量	(Filled Weight): 2Kg
温 度 范 围	(Temperature Range): -30°C-60°C
最大工作压力	(Max Working Pressure): 216Bar
测 试 压 力	(Test Pressure): 315Bar
最 小 壁 厚	(Min Wall-thickness): 2.51mm
材 料	(Material): 34CrMo4
灭 火 级 别	(Fire Class):34B
包 装 尺 寸	(Packing Size):16X13X56cm



5KG WN09-09



外 径	(Out-diameter): Φ 138mm
容 积	(Volume): 6.67L
瓶 高	(Cylinder Length): 600mm
瓶 重	(Cylinder Weight): 8Kg
灭火器重量	(Extinguisher Weight): 14Kg
灭火剂重量	(Filled Weight): 5Kg
温 度 范 围	(Temperature Range): -30°C-60°C
最大工作压力	(Max Working Pressure): 216Bar
测 试 压 力	(Test Pressure): 315Bar
最 小 壁 厚	(Min Wall-thickness): 3.3mm
材 料	(Material): 34CrMo4
灭 火 级 别	(Fire Class): 89B
包 装 尺 寸	(Packing Size): 21X15X73cm





2KG WN10-01



外 径	(Out-diameter): Φ 110mm
容 积	(Volume): 2.3L
瓶 高	(Cylinder Length): 275mm
瓶 重	(Cylinder Weight): 1.4Kg
灭火器重量	(Extinguisher Weight): 3.8Kg
灭火剂重量	(Dry Powder Filled Weight): 2Kg
温 度 范 围	(Temperature Range): -30°C-60°C
最大工作压力	(Max Working Pressure): 18Bar
测 试 压 力	(Test Pressure): 27Bar
最 小 壁 厚	(Min Wall-thickness): 1.08mm
材 料	(Material): St12/DC01
灭 火 级 别	(Fire Class): 13A 89B C
包 装 尺 寸	(Packing Size): 17X18X57cm



1KG WN11-01



外 径	(Out-diameter): Φ 85mm
容 积	(Volume): 1.25L
瓶 高	(Cylinder Length): 270mm
瓶 重	(Cylinder Weight): 0.7Kg
灭火器重量	(Extinguisher Weight): 2.2Kg
灭火剂重量	(Dry Powder Filled Weight): 1Kg
温 度 范 围	(Temperature Range): -30°C-60°C
最大工作压力	(Max Working Pressure): 18Bar
测 试 压 力	(Test Pressure): 27Bar
最 小 壁 厚	(Min Wall-thickness): 1.0mm
材 料	(Material): St12/DC01
灭 火 级 别	(Fire Class): 5A 34B C
包 装 尺 寸	(Packing Size): 10X10X37cm

2KG WN11-02



外 径	(Out-diameter):	Φ 110mm
容 积	(Volume):	2.5L
瓶 高	(Cylinder Length):	310mm
瓶 重	(Cylinder Weight):	1Kg
灭火器重量	(Extinguisher Weight):	3.7Kg
灭火剂重量	(Dry Powder Filled Weight):	2Kg
温 度 范 围	(Temperature Range):	-30℃-60℃
最大工作压力	(Max Working Pressure):	18Bar
测 试 压 力	(Test Pressure):	27Bar
最 小 壁 厚	(Min Wall-thickness):	1.07mm
材 料	(Material):	St12/DC01
灭 火 级 别	(Fire Class):	13A 70B C
包 装 尺 寸	(Packing Size):	12X13X41cm



3KG WN11-03



外 径	(Out-diameter):	Φ 130mm
容 积	(Volume):	3.8L
瓶 高	(Cylinder Length):	335mm
瓶 重	(Cylinder Weight):	1.6Kg
灭火器重量	(Extinguisher Weight):	5Kg
灭火剂重量	(Dry Powder Filled Weight):	3Kg
温 度 范 围	(Temperature Range):	-30℃-60℃
最大工作压力	(Max Working Pressure):	18Bar
测 试 压 力	(Test Pressure):	27Bar
最 小 壁 厚	(Min Wall-thickness):	1.14mm
材 料	(Material):	St12/DC01
灭 火 级 别	(Fire Class):	13A 89B C
包 装 尺 寸	(Packing Size):	14X15X41cm



4KG WN11-04



外 径	(Out-diameter):	Φ 130mm
容 积	(Volume):	5L
瓶 高	(Cylinder Length):	430mm
瓶 重	(Cylinder Weight):	2Kg
灭火器重量	(Extinguisher Weight):	6.7Kg
灭火剂重量	(Dry Powder Filled Weight):	4Kg
温 度 范 围	(Temperature Range):	-30℃-60℃
最大工作压力	(Max Working Pressure):	18Bar
测 试 压 力	(Test Pressure):	27Bar
最 小 壁 厚	(Min Wall-thickness):	1.14mm
材 料	(Material):	St12/DC01
灭 火 级 别	(Fire Class):	21A 113B C
包 装 尺 寸	(Packing Size):	14X15X54cm





5KG WN11-05



外 径	(Out-diameter):	Φ160mm
容 积	(Volume):	6.8L
瓶 高	(Cylinder Length):	390mm
瓶 重	(Cylinder Weight):	2.5Kg
灭火器重量	(Extinguisher Weight):	8Kg
灭火剂重量	(Dry Powder Filled Weight):	5Kg
温 度 范 围	(Temperature Range):	-30℃-60℃
最大工作压力	(Max Working Pressure):	18Bar
测试压力	(Test Pressure):	27Bar
最小壁厚	(Min Wall-thickness):	1.24mm
材 料	(Material):	St12/DC01
灭 火 级 别	(Fire Class):	27A 144B C
包 装 尺 寸	(Packing Size):	17X18X50cm



6KG WN11-06



外 径	(Out-diameter):	Φ160mm
容 积	(Volume):	7.9L
瓶 高	(Cylinder Length):	450mm
瓶 重	(Cylinder Weight):	2.8Kg
灭火器重量	(Extinguisher Weight):	9.5Kg
灭火剂重量	(Dry Powder Filled Weight):	6Kg
温 度 范 围	(Temperature Range):	-30℃-60℃
最大工作压力	(Max Working Pressure):	18Bar
测试压力	(Test Pressure):	27Bar
最小壁厚	(Min Wall-thickness):	1.24mm
材 料	(Material):	St12/DC01
灭 火 级 别	(Fire Class):	27A 183B C
包 装 尺 寸	(Packing Size):	17X18X56cm



8KG WN11-07



外 径	(Out-diameter):	Φ180mm
容 积	(Volume):	9.9L
瓶 高	(Cylinder Length):	445mm
瓶 重	(Cylinder Weight):	3.7Kg
灭火器重量	(Extinguisher Weight):	12Kg
灭火剂重量	(Dry Powder Filled Weight):	8Kg
温 度 范 围	(Temperature Range):	-30℃-60℃
最大工作压力	(Max Working Pressure):	18Bar
测试压力	(Test Pressure):	27Bar
最小壁厚	(Min Wall-thickness):	1.30mm
材 料	(Material):	St12/DC01
灭 火 级 别	(Fire Class):	34A 183B C
包 装 尺 寸	(Packing Size):	19X20X56cm

9KG WN11-08



外 径	(Out-diameter): Φ 180mm
容 积	(Volume): 11.4L
瓶 高	(Cylinder Length): 510mm
瓶 重	(Cylinder Weight): 4Kg
灭火器重量	(Extinguisher Weight): 14Kg
灭火剂重量	(Dry Powder Filled Weight): 9Kg
温 度 范 围	(Temperature Range): -30 $^{\circ}$ C-60 $^{\circ}$ C
最大工作压力	(Max Working Pressure): 18Bar
测试压力	(Test Pressure): 27Bar
最小壁厚	(Min Wall-thickness): 1.30mm
材 料	(Material): St12/DC01
灭 火 级 别	(Fire Class): 34A 183B C
包 装 尺 寸	(Packing Size): 19X20X62cm



10KG WN11-09



外 径	(Out-diameter): Φ 180mm
容 积	(Volume): 12.3L
瓶 高	(Cylinder Length): 545mm
瓶 重	(Cylinder Weight): 4.6Kg
灭火器重量	(Extinguisher Weight): 15.5Kg
灭火剂重量	(Dry Powder Filled Weight): 10Kg
温 度 范 围	(Temperature Range): -30 $^{\circ}$ C-60 $^{\circ}$ C
最大工作压力	(Max Working Pressure): 18Bar
测试压力	(Test Pressure): 27Bar
最小壁厚	(Min Wall-thickness): 1.30mm
材 料	(Material): St12/DC01
灭 火 级 别	(Fire Class): 43A 233B C
包 装 尺 寸	(Packing Size): 19X20X66cm



12G WN11-10



外 径	(Out-diameter): Φ 180mm
容 积	(Volume): 13.6L
瓶 高	(Cylinder Length): 600mm
瓶 重	(Cylinder Weight): 5Kg
灭火器重量	(Extinguisher Weight): 18Kg
灭火剂重量	(Dry Powder Filled Weight): 12Kg
温 度 范 围	(Temperature Range): -30 $^{\circ}$ C-60 $^{\circ}$ C
最大工作压力	(Max Working Pressure): 18Bar
测试压力	(Test Pressure): 27Bar
最小壁厚	(Min Wall-thickness): 1.30mm
材 料	(Material): St12/DC01
灭 火 级 别	(Fire Class): 43A 233B C
包 装 尺 寸	(Packing Size): 19X20X71cm





2L WN12-01



外 径	(Out-diameter): Φ 110mm
容 积	(Volume): 2.43L
瓶 高	(Cylinder Length): 310mm
瓶 重	(Cylinder Weight): 1.4Kg
灭火器重量	(Extinguisher Weight): 4Kg
灭火剂重量	(Filling Weight): 2L
温度范围	(Temperature Range): 0°C-60°C
最大工作压力	(Max Working Pressure): 18Bar
测试压力	(Test Pressure): 27Bar
最小壁厚	(Min Wall-thickness): 1.08mm
材 料	(Material): St12/DC01
灭火级别	(Fire Class): 8A 34B C
包装尺寸	(Packing Size): 12X13X40cm



4L WN12-02



外 径	(Out-diameter): Φ 130mm
容 积	(Volume): 4.8L
瓶 高	(Cylinder Length): 430mm
瓶 重	(Cylinder Weight): 2.3Kg
灭火器重量	(Extinguisher Weight): 7Kg
灭火剂重量	(Filling Weight): 4L
温度范围	(Temperature Range): 0°C-60°C
最大工作压力	(Max Working Pressure): 18Bar
测试压力	(Test Pressure): 27Bar
最小壁厚	(Min Wall-thickness): 1.14mm
材 料	(Material): St12/DC01
灭火级别	(Fire Class): 23A 89B C
包装尺寸	(Packing Size): 14X15X54cm

6L WN12-03



外 径	(Out-diameter): Φ 160mm
容 积	(Volume): 8L
瓶 高	(Cylinder Length): 470mm
瓶 重	(Cylinder Weight): 3.3Kg
灭火器重量	(Extinguisher Weight): 10Kg
灭火剂重量	(Filling Weight): 6L
温度范围	(Temperature Range): 0°C-60°C
最大工作压力	(Max Working Pressure): 18Bar
测试压力	(Test Pressure): 27Bar
最小壁厚	(Min Wall-thickness): 1.24mm
材 料	(Material): St12/DC01
灭火级别	(Fire Class): 21A 144B C
包装尺寸	(Packing Size): 17X18X58cm



9L WN12-04



外 径	(Out-diameter): Φ 180mm
容 积	(Volume): 11.33L
瓶 高	(Cylinder Length): 525mm
瓶 重	(Cylinder Weight): 5.0Kg
灭火器重量	(Extinguisher Weight): 14.6Kg
灭火剂重量	(Filling Weight): 9L
温度范围	(Temperature Range): 0°C-60°C
最大工作压力	(Max Working Pressure): 18Bar
测试压力	(Test Pressure): 27Bar
最小壁厚	(Min Wall-thickness): 1.30mm
材 料	(Material): St12/DC01
灭火级别	(Fire Class): 21A 183B C
包装尺寸	(Packing Size): 19X20X64cm





1KG WN13-01

外 径	(Out-diameter):	Φ111mm
容 积	(Volume):	1.5L
瓶 高	(Cylinder Length):	275mm
瓶 重	(Cylinder Weight):	2Kg
灭火器重量	(Extinguisher Weight):	3.7Kg
灭火剂重量	(Filling Weight):	1Kg
温 度 范 围	(Temperature Range):	-20℃-60℃
最大工作压力	(Max Working Pressure):	174Bar
测试压力	(Test Pressure):	250Bar
最小壁厚	(Min Wall-thickness):	6.32mm
材 料	(Material):	AA6061
灭 火 级 别	(Fire Class):	21B
包 装 尺 寸	(Packing Size):	16X13X39.5cm



2KG WN13-02

外 径	(Out-diameter):	Φ111mm
容 积	(Volume):	3L
瓶 高	(Cylinder Length):	475mm
瓶 重	(Cylinder Weight):	3.2Kg
灭火器重量	(Extinguisher Weight):	6Kg
灭火剂重量	(Filling Weight):	2Kg
温 度 范 围	(Temperature Range):	-20℃-60℃
最大工作压力	(Max Working Pressure):	174Bar
测试压力	(Test Pressure):	250Bar
最小壁厚	(Min Wall-thickness):	6.32mm
材 料	(Material):	AA6061
灭 火 级 别	(Fire Class):	34B
包 装 尺 寸	(Packing Size):	16X13X59.5cm



3KG WN13-03

外 径	(Out-diameter):	Φ140mm
容 积	(Volume):	4.5L
瓶 高	(Cylinder Length):	440mm
瓶 重	(Cylinder Weight):	4Kg
灭火器重量	(Extinguisher Weight):	8Kg
灭火剂重量	(Filling Weight):	3Kg
温 度 范 围	(Temperature Range):	-20℃-60℃
最大工作压力	(Max Working Pressure):	174Bar
测试压力	(Test Pressure):	250Bar
最小壁厚	(Min Wall-thickness):	6.5mm
材 料	(Material):	AA6061
灭 火 级 别	(Fire Class):	34B
包 装 尺 寸	(Packing Size):	21X15X56cm

4KG WN13-04

外 径	(Out-diameter): Φ 140mm
容 积	(Volume): 6L
瓶 高	(Cylinder Length): 560mm
瓶 重	(Cylinder Weight): 6.5Kg
灭火器重量	(Extinguisher Weight): 11.6Kg
灭火剂重量	(Filling Weight): 4Kg
温 度 范 围	(Temperature Range): -20°C-60°C
最大工作压力	(Max Working Pressure): 174Bar
测试压力	(Test Pressure): 250Bar
最小壁厚	(Min Wall-thickness): 6.5mm
材 料	(Material): AA6061
灭 火 级 别	(Fire Class): 70B
包 装 尺 寸	(Packing Size): 21X15X68cm



5KG WN13-05

外 径	(Out-diameter): Φ 159mm
容 积	(Volume): 7.5L
瓶 高	(Cylinder Length): 560mm
瓶 重	(Cylinder Weight): 6.7Kg
灭火器重量	(Extinguisher Weight): 13Kg
灭火剂重量	(Filling Weight): 5Kg
温 度 范 围	(Temperature Range): -20°C-60°C
最大工作压力	(Max Working Pressure): 174Bar
测试压力	(Test Pressure): 250Bar
最小壁厚	(Min Wall-thickness): 7.38mm
材 料	(Material): AA6061
灭 火 级 别	(Fire Class): 89B
包 装 尺 寸	(Packing Size): 22X17X68cm



6KG WN13-06

外 径	(Out-diameter): Φ 159mm
容 积	(Volume): 9L
瓶 高	(Cylinder Length): 680mm
瓶 重	(Cylinder Weight): 9.6Kg
灭火器重量	(Extinguisher Weight): 16.7Kg
灭火剂重量	(Filling Weight): 6Kg
温 度 范 围	(Temperature Range): -20°C-60°C
最大工作压力	(Max Working Pressure): 174Bar
测试压力	(Test Pressure): 250Bar
最小壁厚	(Min Wall-thickness): 7.38mm
材 料	(Material): AA6061
灭 火 级 别	(Fire Class): 89B
包 装 尺 寸	(Packing Size): 22X17X68cm





1.3KG WN14-01

外 径	(Out-diameter):	Φ105mm
容 积	(Volume):	2L
瓶 高	(Cylinder Length):	355mm
瓶 重	(Cylinder Weight):	3.4Kg
灭火器重量	(Extinguisher Weight):	5.4Kg
灭火剂重量	(Filling Weight):	1.3Kg
温 度 范 围	(Temperature Range):	-20℃-60℃
最大工作压力	(Max Working Pressure):	174Bar
测试压力	(Test Pressure):	250Bar
最小壁厚	(Min Wall-thickness):	2.3mm
材 料	(Material):	34CrMo4
灭 火 级 别	(Fire Class):	21B
包 装 尺 寸	(Packing Size):	16X13X48cm



2KG WN14-02

外 径	(Out-diameter):	Φ105mm
容 积	(Volume):	3L
瓶 高	(Cylinder Length):	475mm
瓶 重	(Cylinder Weight):	4.3Kg
灭火器重量	(Extinguisher Weight):	7Kg
灭火剂重量	(Filling Weight):	2Kg
温 度 范 围	(Temperature Range):	-20℃-60℃
最大工作压力	(Max Working Pressure):	174Bar
测试压力	(Test Pressure):	250Bar
最小壁厚	(Min Wall-thickness):	2.3mm
材 料	(Material):	34CrMo4
灭 火 级 别	(Fire Class):	34B
包 装 尺 寸	(Packing Size):	16X13X60cm



2.3KG WN14-03

外 径	(Out-diameter):	Φ105mm
容 积	(Volume):	3.5L
瓶 高	(Cylinder Length):	530mm
瓶 重	(Cylinder Weight):	5Kg
灭火器重量	(Extinguisher Weight):	8Kg
灭火剂重量	(Filling Weight):	2.3Kg
温 度 范 围	(Temperature Range):	-20℃-60℃
最大工作压力	(Max Working Pressure):	174Bar
测试压力	(Test Pressure):	250Bar
最小壁厚	(Min Wall-thickness):	2.3mm
材 料	(Material):	34CrMo4
灭 火 级 别	(Fire Class):	34B
包 装 尺 寸	(Packing Size):	16X13X65cm

3KG WN14-04

外 径	(Out-diameter): Φ 138mm
容 积	(Volume): 4.5L
瓶 高	(Cylinder Length): 440mm
瓶 重	(Cylinder Weight): 7Kg
灭火器重量	(Extinguisher Weight): 11Kg
灭火剂重量	(Filling Weight): 3Kg
温度范围	(Temperature Range): -20°C-60°C
最大工作压力	(Max Working Pressure): 174Bar
测试压力	(Test Pressure): 250Bar
最小壁厚	(Min Wall-thickness): 3mm
材 料	(Material): 34CrMo4
灭火级别	(Fire Class): 34B
包装尺寸	(Packing Size): 21X15X56cm



4KG WN14-05

外 径	(Out-diameter): Φ 138mm
容 积	(Volume): 6L
瓶 高	(Cylinder Length): 550mm
瓶 重	(Cylinder Weight): 8Kg
灭火器重量	(Extinguisher Weight): 13Kg
灭火剂重量	(Filling Weight): 4Kg
温度范围	(Temperature Range): -20°C-60°C
最大工作压力	(Max Working Pressure): 174Bar
测试压力	(Test Pressure): 250Bar
最小壁厚	(Min Wall-thickness): 3mm
材 料	(Material): 34CrMo4
灭火级别	(Fire Class): 70B
包装尺寸	(Packing Size): 21X15X67cm



4.5KG WN14-06

外 径	(Out-diameter): Φ 138mm
容 积	(Volume): 6.8L
瓶 高	(Cylinder Length): 600mm
瓶 重	(Cylinder Weight): 8Kg
灭火器重量	(Extinguisher Weight): 14Kg
灭火剂重量	(Filling Weight): 4.5Kg
温度范围	(Temperature Range): -20°C-60°C
最大工作压力	(Max Working Pressure): 174Bar
测试压力	(Test Pressure): 250Bar
最小壁厚	(Min Wall-thickness): 3mm
材 料	(Material): 34CrMo4
灭火级别	(Fire Class): 70B
包装尺寸	(Packing Size): 21X15X73cm





5KG WN14-07

外 径	(Out-diameter):	Φ138mm
容 积	(Volume):	7.5L
瓶 高	(Cylinder Length):	655mm
瓶 重	(Cylinder Weight):	8.6Kg
灭火器重量	(Extinguisher Weight):	15Kg
灭火剂重量	(Filling Weight):	5Kg
温 度 范 围	(Temperature Range):	-20℃-60℃
最大工作压力	(Max Working Pressure):	174Bar
测 试 压 力	(Test Pressure):	250Bar
最 小 壁 厚	(Min Wall-thickness):	3mm
材 料	(Material):	34CrMo4
灭 火 级 别	(Fire Class):	89B
包 装 尺 寸	(Packing Size):	21X15X78cm



6KG WN14-08

外 径	(Out-diameter):	Φ156mm
容 积	(Volume):	9L
瓶 高	(Cylinder Length):	625mm
瓶 重	(Cylinder Weight):	10.4Kg
灭火器重量	(Extinguisher Weight):	18Kg
灭火剂重量	(Filling Weight):	6Kg
温 度 范 围	(Temperature Range):	-20℃-60℃
最大工作压力	(Max Working Pressure):	174Bar
测 试 压 力	(Test Pressure):	250Bar
最 小 壁 厚	(Min Wall-thickness):	3.4mm
材 料	(Material):	34CrMo4
灭 火 级 别	(Fire Class):	89B
包 装 尺 寸	(Packing Size):	21X17X75cm

1.3KG WN15-01

外 径	(Out-diameter): Φ 114mm
容 积	(Volume): 2L
瓶 高	(Cylinder Length): 325mm
瓶 重	(Cylinder Weight): 4.5Kg
灭火器重量	(Extinguisher Weight): 6.5Kg
灭火剂重量	(Filling Weight): 1.3Kg
温 度 范 围	(Temperature Range): -20°C-60°C
最大工作压力	(Max Working Pressure): 174Bar
测试压力	(Test Pressure): 250Bar
最小壁厚	(Min Wall-thickness): 4.5mm
材 料	(Material): CK45
灭火级别	(Fire Class): 21B
包装尺寸	(Packing Size): 17X13X45cm



2KG WN15-02

外 径	(Out-diameter): Φ 114mm
容 积	(Volume): 3L
瓶 高	(Cylinder Length): 420mm
瓶 重	(Cylinder Weight): 5.7Kg
灭火器重量	(Extinguisher Weight): 8.5Kg
灭火剂重量	(Filling Weight): 2Kg
温 度 范 围	(Temperature Range): -20°C-60°C
最大工作压力	(Max Working Pressure): 174Bar
测试压力	(Test Pressure): 250Bar
最小壁厚	(Min Wall-thickness): 4.5mm
材 料	(Material): CK45
灭火级别	(Fire Class): 34B
包装尺寸	(Packing Size): 17X13X55cm





2.3KG WN15-03

外 径	(Out-diameter): Φ 114mm
容 积	(Volume): 3.5L
瓶 高	(Cylinder Length): 480mm
瓶 重	(Cylinder Weight): 6.5Kg
灭火器重量	(Extinguisher Weight): 10Kg
灭火剂重量	(Filling Weight): 2.3Kg
温 度 范 围	(Temperature Range): -20°C-60°C
最大工作压力	(Max Working Pressure): 174Bar
测试压力	(Test Pressure): 250Bar
最小壁厚	(Min Wall-thickness): 4.5mm
材 料	(Material): CK45
灭火级别	(Fire Class): 34B
包装尺寸	(Packing Size): 17X13X60cm



3KG WN15-04

外 径	(Out-diameter): Φ 114mm
容 积	(Volume): 4.5L
瓶 高	(Cylinder Length): 605mm
瓶 重	(Cylinder Weight): 8Kg
灭火器重量	(Extinguisher Weight): 11.7Kg
灭火剂重量	(Filling Weight): 3Kg
温 度 范 围	(Temperature Range): -20°C-60°C
最大工作压力	(Max Working Pressure): 174Bar
测试压力	(Test Pressure): 250Bar
最小壁厚	(Min Wall-thickness): 4.5mm
材 料	(Material): CK45
灭火级别	(Fire Class): 34B
包装尺寸	(Packing Size): 17X13X73cm

4KG WN15-05

外 径	(Out-diameter):	Φ152mm
容 积	(Volume):	6L
瓶 高	(Cylinder Length):	480mm
瓶 重	(Cylinder Weight):	11Kg
灭火器重量	(Extinguisher Weight):	16Kg
灭火剂重量	(Filling Weight):	4Kg
温 度 范 围	(Temperature Range):	-20℃-60℃
最大工作压力	(Max Working Pressure):	174Bar
测试 压 力	(Test Pressure):	250Bar
最 小 壁 厚	(Min Wall-thickness):	5.5mm
材 料	(Material):	CK45
灭 火 级 别	(Fire Class):	70B
包 装 尺 寸	(Packing Size):	21X17X60cm



4.5KG WN15-06

外 径	(Out-diameter):	Φ152mm
容 积	(Volume):	6.8L
瓶 高	(Cylinder Length):	520mm
瓶 重	(Cylinder Weight):	12Kg
灭火器重量	(Extinguisher Weight):	17.5Kg
灭火剂重量	(Filling Weight):	4.5Kg
温 度 范 围	(Temperature Range):	-20℃-60℃
最大工作压力	(Max Working Pressure):	174Bar
测试 压 力	(Test Pressure):	250Bar
最 小 壁 厚	(Min Wall-thickness):	5.5mm
材 料	(Material):	CK45
灭 火 级 别	(Fire Class):	70B
包 装 尺 寸	(Packing Size):	21X17X65cm



5KG WN15-07

外 径	(Out-diameter):	Φ152mm
容 积	(Volume):	7.5L
瓶 高	(Cylinder Length):	570mm
瓶 重	(Cylinder Weight):	13Kg
灭火器重量	(Extinguisher Weight):	19Kg
灭火剂重量	(Filling Weight):	5Kg
温 度 范 围	(Temperature Range):	-20℃-60℃
最大工作压力	(Max Working Pressure):	174Bar
测试 压 力	(Test Pressure)	250Bar
最 小 壁 厚	(Min Wall-thickness):	5.5mm
材 料	(Material):	CK45
灭 火 级 别	(Fire Class):	89B
包 装 尺 寸	(Packing Size):	21X17X71cm





6KG WN15-08

外 径	(Out-diameter):	Φ 152mm
容 积	(Volume):	9L
瓶 高	(Cylinder Length):	670mm
瓶 重	(Cylinder Weight):	15Kg
灭火器重量	(Extinguisher Weight):	22Kg
灭火剂重量	(Filling Weight):	6Kg
温 度 范 围	(Temperature Range):	-20℃-60℃
最大工作压力	(Max Working Pressure):	174Bar
测试压力	(Test Pressure):	250Bar
最小壁厚	(Min Wall-thickness):	5.5mm
材 料	(Material):	CK45
灭 火 级 别	(Fire Class):	89B
包 装 尺 寸	(Packing Size):	21X17X79cm



7KG WN15-09

外 径	(Out-diameter):	Φ 152mm
容 积	(Volume):	10.5L
瓶 高	(Cylinder Length):	770mm
瓶 重	(Cylinder Weight):	17Kg
灭火器重量	(Extinguisher Weight):	25Kg
灭火剂重量	(Filling Weight):	7Kg
温 度 范 围	(Temperature Range):	-20℃-60℃
最大工作压力	(Max Working Pressure):	174Bar
测试压力	(Test Pressure):	250Bar
最小壁厚	(Min Wall-thickness):	5.5mm
材 料	(Material):	CK45
灭 火 级 别	(Fire Class):	113B
包 装 尺 寸	(Packing Size):	21X17X89cm



9KG WN15-10

外 径	(Out-diameter):	Φ 152mm
容 积	(Volume):	13.5L
瓶 高	(Cylinder Length):	980mm
瓶 重	(Cylinder Weight):	20Kg
灭火器重量	(Extinguisher Weight):	30Kg
灭火剂重量	(Filling Weight):	9Kg
温 度 范 围	(Temperature Range):	-20℃-60℃
最大工作压力	(Max Working Pressure):	174Bar
测试压力	(Test Pressure):	250Bar
最小壁厚	(Min Wall-thickness):	5.5mm
材 料	(Material):	CK45
灭 火 级 别	(Fire Class):	113B
包 装 尺 寸	(Packing Size):	21X17X110cm

0.5KG WN16-01

外 径	(Out-diameter): Φ 66mm
容 积	(Volume): 0.68L
瓶 高	(Cylinder Length): 245mm
瓶 重	(Cylinder Weight): 0.4Kg
灭火器重量	(Extinguisher Weight): 1.2Kg
灭火剂重量	(Dry Powder Filled Weight): 0.5Kg
温 度 范 围	(Temperature Range): -30°C-60°C
最大工作压力	(Max Working Pressure): 18Bar
测 试 压 力	(Test Pressure): 27Bar
最 小 壁 厚	(Min Wall-thickness): 0.80mm
材 料	(Material): St12/DC01
灭 火 级 别	(Fire Class): 5A 34B C
包 装 尺 寸	(Packing Size): 8X8X34cm



1KG WN16-02

外 径	(Out-diameter): Φ 90mm
容 积	(Volume): 1.2L
瓶 高	(Cylinder Length): 235mm
瓶 重	(Cylinder Weight): 0.6Kg
灭火器重量	(Extinguisher Weight): 2Kg
灭火剂重量	(Dry Powder Filled Weight): 1Kg
温 度 范 围	(Temperature Range): -30°C-60°C
最大工作压力	(Max Working Pressure): 18Bar
测 试 压 力	(Test Pressure): 27Bar
最 小 壁 厚	(Min Wall-thickness): 0.80mm
材 料	(Material): St12/DC01
灭 火 级 别	(Fire Class): 5A 34B C
包 装 尺 寸	(Packing Size): 10X11X34cm



2KG WN16-03

外 径	(Out-diameter): Φ 110mm
容 积	(Volume): 2.42L
瓶 高	(Cylinder Length): 310mm
瓶 重	(Cylinder Weight): 1.2Kg
灭火器重量	(Extinguisher Weight): 3.4Kg
灭火剂重量	(Dry Powder Filled Weight): 2Kg
温 度 范 围	(Temperature Range): -30°C-60°C
最大工作压力	(Max Working Pressure): 18Bar
测 试 压 力	(Test Pressure): 27Bar
最 小 壁 厚	(Min Wall-thickness): 1.07mm
材 料	(Material): St12/DC01
灭 火 级 别	(Fire Class): 13A 70B C
包 装 尺 寸	(Packing Size): 11X12X44cm



2.3KG WN16-04



外 径	(Out-diameter): Φ 110mm
容 积	(Volume): 2.75L
瓶 高	(Cylinder Length): 350mm
瓶 重	(Cylinder Weight): 1.3Kg
灭火器重量	(Extinguisher Weight): 3.4Kg
灭火剂重量	(Dry Powder Filled Weight): 2.3Kg
温 度 范 围	(Temperature Range): -30°C-60°C
最大工作压力	(Max Working Pressure): 18Bar
测试压力	(Test Pressure): 27Bar
最小壁厚	(Min Wall-thickness): 1.07mm
材 料	(Material): St12/DC01
灭 火 级 别	(Fire Class): 13A 89B C
包 装 尺 寸	(Packing Size): 14X15X43cm

3KG WN16-05



外 径	(Out-diameter): Φ 130mm
容 积	(Volume): 3.55L
瓶 高	(Cylinder Length): 320mm
瓶 重	(Cylinder Weight): 1.4Kg
灭火器重量	(Extinguisher Weight): 4Kg
灭火剂重量	(Dry Powder Filled Weight): 3Kg
温 度 范 围	(Temperature Range): -30°C-60°C
最大工作压力	(Max Working Pressure): 18Bar
测试压力	(Test Pressure): 27Bar
最小壁厚	(Min Wall-thickness): 1.14mm
材 料	(Material): St12/DC01
灭 火 级 别	(Fire Class): 21A 113B C
包 装 尺 寸	(Packing Size): 14X15X53cm

4KG WN16-06



外 径	(Out-diameter): Φ 140mm
容 积	(Volume): 4.9L
瓶 高	(Cylinder Length): 375mm
瓶 重	(Cylinder Weight): 2.0Kg
灭火器重量	(Extinguisher Weight): 6.4Kg
灭火剂重量	(Dry Powder Filled Weight): 4Kg
温 度 范 围	(Temperature Range): -30°C-60°C
最大工作压力	(Max Working Pressure): 18Bar
测试压力	(Test Pressure): 27Bar
最小壁厚	(Min Wall-thickness): 1.17mm
材 料	(Material): St12/DC01
灭 火 级 别	(Fire Class): 21A 113B C
包 装 尺 寸	(Packing Size): 15X16X43cm

4.5KG WN16-07

外 径	(Out-diameter): Φ 140mm
容 积	(Volume): 5.45L
瓶 高	(Cylinder Length): 420mm
瓶 重	(Cylinder Weight): 2.2Kg
灭火器重量	(Extinguisher Weight): 7Kg
灭火剂重量	(Dry Powder Filled Weight): 4.5Kg
温 度 范 围	(Temperature Range): -30 $^{\circ}$ C-60 $^{\circ}$ C
最大工作压力	(Max Working Pressure): 18Bar
测试压力	(Test Pressure): 27Bar
最小壁厚	(Min Wall-thickness): 1.17mm
材 料	(Material): St12/DC01
灭 火 级 别	(Fire Class): 27A 144B C
包 装 尺 寸	(Packing Size): 15X16X45cm



5KG WN16-08

外 径	(Out-diameter): Φ 150mm
容 积	(Volume): 5.95L
瓶 高	(Cylinder Length): 400mm
瓶 重	(Cylinder Weight): 2.3Kg
灭火器重量	(Extinguisher Weight): 7.7Kg
灭火剂重量	(Dry Powder Filled Weight): 5Kg
温 度 范 围	(Temperature Range): -30 $^{\circ}$ C-60 $^{\circ}$ C
最大工作压力	(Max Working Pressure): 18Bar
测试压力	(Test Pressure): 27Bar
最小壁厚	(Min Wall-thickness): 1.20mm
材 料	(Material): St12/DC01
灭 火 级 别	(Fire Class): 27A 144B C
包 装 尺 寸	(Packing Size): 16X17X51cm



6KG WN16-09

外 径	(Out-diameter): Φ 163mm
容 积	(Volume): 7.0L
瓶 高	(Cylinder Length): 410mm
瓶 重	(Cylinder Weight): 3.0Kg
灭火器重量	(Extinguisher Weight): 9.5Kg
灭火剂重量	(Dry Powder Filled Weight): 6Kg
温 度 范 围	(Temperature Range): -30 $^{\circ}$ C-60 $^{\circ}$ C
最大工作压力	(Max Working Pressure): 18Bar
测试压力	(Test Pressure): 27Bar
最小壁厚	(Min Wall-thickness): 1.24mm
材 料	(Material): St12/DC01
灭 火 级 别	(Fire Class): 27A 144B C
包 装 尺 寸	(Packing Size): 17X18X46cm





8KG WN16-10

外 径	(Out-diameter): Φ 163mm
容 积	(Volume): 9L
瓶 高	(Cylinder Length): 505mm
瓶 重	(Cylinder Weight): 3.6Kg
灭火器重量	(Extinguisher Weight): 12Kg
灭火剂重量	(Dry Powder Filled Weight): 8Kg
温度范围	(Temperature Range): -30 $^{\circ}$ C-60 $^{\circ}$ C
最大工作压力	(Max Working Pressure): 18Bar
测试压力	(Test Pressure): 27Bar
最小壁厚	(Min Wall-thickness): 1.24mm
材 料	(Material): St12/DC01
灭火级别	(Fire Class): 34A 183B C
包装尺寸	(Packing Size): 17X18X62cm



9KG WN16-11

外 径	(Out-diameter): Φ 180mm
容 积	(Volume): 10.7L
瓶 高	(Cylinder Length): 490mm
瓶 重	(Cylinder Weight): 4.0Kg
灭火器重量	(Extinguisher Weight): 13.6Kg
灭火剂重量	(Dry Powder Filled Weight): 9Kg
温度范围	(Temperature Range): -30 $^{\circ}$ C-60 $^{\circ}$ C
最大工作压力	(Max Working Pressure): 18Bar
测试压力	(Test Pressure): 27Bar
最小壁厚	(Min Wall-thickness): 1.30mm
材 料	(Material): St12/DC01
灭火级别	(Fire Class): 34A 233B C
包装尺寸	(Packing Size): 19X20X60cm

10KG WN16-12

外 径	(Out-diameter): Φ 180mm
容 积	(Volume): 11.65L
瓶 高	(Cylinder Length): 530mm
瓶 重	(Cylinder Weight): 4.2Kg
灭火器重量	(Extinguisher Weight): 15Kg
灭火剂重量	(Dry Powder Filled Weight): 10Kg
温度范围	(Temperature Range): -30 $^{\circ}$ C-60 $^{\circ}$ C
最大工作压力	(Max Working Pressure): 18Bar
测试压力	(Test Pressure): 27Bar
最小壁厚	(Min Wall-thickness): 1.30mm
材 料	(Material): St12/DC01
灭火级别	(Fire Class): 43A 233B C
包装尺寸	(Packing Size): 19X20X64cm



12KG WN16-13

外 径	(Out-diameter): Φ 180mm
容 积	(Volume): 13.5L
瓶 高	(Cylinder Length): 600mm
瓶 重	(Cylinder Weight): 4.3Kg
灭火器重量	(Extinguisher Weight): 17Kg
灭火剂重量	(Dry Powder Filled Weight): 12Kg
温度范围	(Temperature Range): -30 $^{\circ}$ C-60 $^{\circ}$ C
最大工作压力	(Max Working Pressure): 18Bar
测试压力	(Test Pressure): 27Bar
最小壁厚	(Min Wall-thickness): 1.30mm
材 料	(Material): St12/DC01
灭火级别	(Fire Class): 55A 233B C
包装尺寸	(Packing Size): 19X20X71cm





4KG WN17-01

外 径	(Out-diameter): Φ 140mm
容 积	(Volume): 5.3L
瓶 高	(Cylinder Length): 405mm
瓶 重	(Cylinder Weight): 2.2Kg
灭火器重量	(Extinguisher Weight): 8Kg
灭火剂重量	(Dry Powder Filled Weight): 4Kg
温度范围	(Temperature Range): -30 $^{\circ}$ C-60 $^{\circ}$ C
测试压力	(Test Pressure): 27Bar
最小壁厚	(Min Wall-thickness): 1.17mm
材 料	(Material): St12/DC01
灭火级别	(Fire Class): 21A 113B C
包装尺寸	(Packing Size): 15X16X52cm
内置小钢瓶	(Internal gas cartridge)
驱动气体	(Drive gas): CO2(75)g
材 料	(Material): St52



6KG WN17-02

外 径	(Out-diameter): Φ 160mm
容 积	(Volume): 7.9L
瓶 高	(Cylinder Length): 455mm
瓶 重	(Cylinder Weight): 3Kg
灭火器重量	(Extinguisher Weight): 11Kg
灭火剂重量	(Dry Powder Filled Weight): 8Kg
温度范围	(Temperature Range): -30 $^{\circ}$ C-60 $^{\circ}$ C
测试压力	(Test Pressure(Bar): 27Bar
最小壁厚	(Min Wall-thickness): 1.24mm
材 料	(Material): St12/DC01
灭火级别	(Fire Class): 27A 183B C
包装尺寸	(Packing Size): 17X18X57cm
内置小钢瓶	(Internal gas cartridge)
驱动气体	(Drive gas): CO2(120)g
材 料	(Material): St52

9KG WN17-03

外 径	(Out-diameter): Φ 180mm
容 积	(Volume): 11.4L
瓶 高	(Cylinder Length): 515mm
瓶 重	(Cylinder Weight): 4.4Kg
灭火器重量	(Extinguisher Weight): 15Kg
灭火剂重量	(Dry Powder Filled Weight): 9Kg
温 度 范 围	(Temperature Range): -30 $^{\circ}$ C-60 $^{\circ}$ C
测 试 压 力	(Test Pressure): 27Bar
最 小 壁 厚	(Min Wall-thickness): 1.30mm
材 料	(Material): St12/DC01
灭 火 级 别	(Fire Class): 34A 233B C
包 装 尺 寸	(Packing Size): 19X20X63cm

内置小钢瓶	(Internal gas cartridge)
驱 动 气 体	(Drive gas): CO2(150g)
材 料	(Material): St52



12KG WN17-04

外 径	(Out-diameter): Φ 180mm
容 积	(Volume): 13.6L
瓶 高	(Cylinder Length): 605mm
瓶 重	(Cylinder Weight): 5Kg
灭火器重量	(Extinguisher Weight): 18.5Kg
灭火剂重量	(Dry Powder Filled Weight): 12Kg
温 度 范 围	(Temperature Range): -30 $^{\circ}$ C-60 $^{\circ}$ C
测 试 压 力	(Test Pressure): 27Bar
最 小 壁 厚	(Min Wall-thickness): 1.30mm
材 料	(Material): St12/DC01
灭 火 级 别	(Fire Class): 43A 233B C
包 装 尺 寸	(Packing Size): 19X20X42cm

内置小钢瓶	(Internal gas cartridge)
驱 动 气 体	(Drive gas): CO2(180g)
材 料	(Material): St52





6KG WN18-01

外 径	(Out-diameter):	Φ160mm
容 积	(Volume):	7.35L
瓶 高	(Cylinder Length):	450mm
瓶 重	(Cylinder Weight):	3.6Kg
灭火器重量	(Extinguisher Weight):	11.6Kg
灭火剂重量	(Dry Powder Filled Weight):	6Kg
温 度 范 围	(Temperature Range):	-30℃-60℃
测 试 压 力	(Test Pressure):	27Bar
最 小 壁 厚	(Min Wall-thickness):	1.24mm
材 料	(Material):	St12/DC01
灭 火 级 别	(Fire Class):	27A 183B C
包 装 尺 寸	(Packing Size):	17X18X56cm
外置小钢瓶	(External gas cartridge)	
驱 动 气 体	(Drive gas):	CO2(250)g
材 料	(Material):	20#



9KG WN18-02

外 径	(Out-diameter):	Φ180mm
容 积	(Volume):	11.3L
瓶 高	(Cylinder Length):	520mm
瓶 重	(Cylinder Weight):	4.6Kg
灭火器重量	(Extinguisher Weight):	16Kg
灭火剂重量	(Dry Powder Filled Weight):	9Kg
温 度 范 围	(Temperature Range):	-30℃-60℃
测 试 压 力	(Test Pressure):	27Bar
最 小 壁 厚	(Min Wall-thickness):	1.30mm
材 料	(Material):	St12/DC01
灭 火 级 别	(Fire Class):	34A 233B C
包 装 尺 寸	(Packing Size):	19X20X63cm
外置小钢瓶	(External gas cartridge)	
驱 动 气 体	(Drive gas):	CO2(300)g
材 料	(Material):	20#

10KG WN18-03

外 径	(Out-diameter): Φ 180mm
容 积	(Volume): 11.78L
瓶 高	(Cylinder Length): 540mm
瓶 重	(Cylinder Weight): 17.5Kg
灭火器重量	(Extinguisher Weight): 11.6Kg
灭火剂重量	(Dry Powder Filled Weight): 10Kg
温度范围	(Temperature Range): -30℃-60℃
测试压力	(Test Pressure): 27Bar
最小壁厚	(Min Wall-thickness): 1.30mm
材 料	(Material): St12/DC01
灭火级别	(Fire Class): 43A 233B C
包装尺寸	(Packing Size): 19X20X65cm

外置小钢瓶	(External gas cartridge)
驱动气体	(Drive gas): CO ₂ (300)g
材 料	(Material): 20#



12KG WN18-04

外 径	(Out-diameter): Φ 180mm
容 积	(Volume): 13.8L
瓶 高	(Cylinder Length): 620mm
瓶 重	(Cylinder Weight): 5.7Kg
灭火器重量	(Extinguisher Weight): 21Kg
灭火剂重量	(Dry Powder Filled Weight): 12Kg
温度范围	(Temperature Range): -30℃-60℃
测试压力	(Test Pressure): 27Bar
最小壁厚	(Min Wall-thickness): 1.30mm
材 料	(Material): St12/DC01
灭火级别	(Fire Class): 43A 233B C
包装尺寸	(Packing Size): 19X20X73cm

外置小钢瓶	(External gas cartridge)
驱动气体	(Drive gas): CO ₂ (350)g
材 料	(Material): 20#





4.5KG WN19-01

外 径	(Out-diameter):	Φ194mm
容 积	(Volume):	5.5L
瓶 高	(Cylinder Length):	240mm
瓶 重	(Cylinder Weight):	2.2Kg
灭火器重量	(Extinguisher Weight):	7.4Kg
灭火剂重量	(Dry Powder Filled Weight):	4.5Kg
温 度 范 围	(Temperature Range):	-10℃-50℃
工 作 压 力	(Working Pressure):	14Bar
测 试 压 力	(Test Pressure):	25Bar
最 小 壁 厚	(Min Wall-thickness):	1.35mm
材 料	(Material):	St12/DC01
灭 火 级 别	(Fire Class):	21A 113B C
包 装 尺 寸	(Packing Size):	20X21X35cm



6KG WN19-02

外 径	(Out-diameter):	Φ292mm
容 积	(Volume):	7.6L
瓶 高	(Cylinder Length):	180mm
瓶 重	(Cylinder Weight):	2.7Kg
灭火器重量	(Extinguisher Weight):	10Kg
灭火剂重量	(Dry Powder Filled Weight):	6Kg
温 度 范 围	(Temperature Range):	-10℃-50℃
工 作 压 力	(Working Pressure):	14Bar
测 试 压 力	(Test Pressure):	25Bar
最 小 壁 厚	(Min Wall-thickness):	2.30mm
材 料	(Material):	St12/DC01
灭 火 级 别	(Fire Class):	27A 183B C
包 装 尺 寸	(Packing Size):	30X30X29cm



12KG WN19-03

外 径	(Out-diameter):	Φ370mm
容 积	(Volume):	15L
瓶 高	(Cylinder Length):	220mm
瓶 重	(Cylinder Weight):	4.5Kg
灭火器重量	(Extinguisher Weight):	17Kg
灭火剂重量	(Dry Powder Filled Weight):	12Kg
温 度 范 围	(Temperature Range):	-10℃-50℃
工 作 压 力	(Working Pressure):	14Bar
测 试 压 力	(Test Pressure):	25Bar
最 小 壁 厚	(Min Wall-thickness):	2.05mm
材 料	(Material):	St12/DC01
灭 火 级 别	(Fire Class):	43A 233B C
包 装 尺 寸	(Packing Size):	38X39X34cm

1KG WN20-01

外 径	(Out-diameter): Φ 90mm
容 积	(Volume): 1.3L
瓶 高	(Cylinder Length): 250mm
瓶 重	(Cylinder Weight): 0.6Kg
灭火器重量	(Extinguisher Weight): 2.1Kg
灭火剂重量	(Dry Powder Filled Weight): 1Kg
温 度 范 围	(Temperature Range): -30°C-60°C
最大工作压力	(Max Working Pressure): 18Bar
测 试 压 力	(Test Pressure): 27Bar
最 小 壁 厚	(Min Wall-thickness): 0.70mm
材 料	(Material): 304
灭 火 级 别	(Fire Class): 5A 34B C
包 装 尺 寸	(Packing Size): 10X10X34cm



2KG WN20-02

外 径	(Out-diameter): Φ 110mm
容 积	(Volume): 2.5L
瓶 高	(Cylinder Length): 310mm
瓶 重	(Cylinder Weight): 1Kg
灭火器重量	(Extinguisher Weight): 3.5Kg
灭火剂重量	(Dry Powder Filled Weight): 2Kg
温 度 范 围	(Temperature Range): -30°C-60°C
最大工作压力	(Max Working Pressure): 18Bar
测 试 压 力	(Test Pressure): 27Bar
最 小 壁 厚	(Min Wall-thickness): 0.80mm
材 料	(Material): 304
灭 火 级 别	(Fire Class): 13A 70B C
包 装 尺 寸	(Packing Size): 12X13X40cm



4KG WN20-03

外 径	(Out-diameter): Φ 130mm
容 积	(Volume): 4.7L
瓶 高	(Cylinder Length): 410mm
瓶 重	(Cylinder Weight): 1.5Kg
灭火器重量	(Extinguisher Weight): 6Kg
灭火剂重量	(Dry Powder Filled Weight): 4Kg
温 度 范 围	(Temperature Range): -30°C-60°C
最大工作压力	(Max Working Pressure): 18Bar
测 试 压 力	(Test Pressure): 27Bar
最 小 壁 厚	(Min Wall-thickness): 0.80mm
材 料	(Material): 304
灭 火 级 别	(Fire Class): 21A 113B C
包 装 尺 寸	(Packing Size): 14X15X51cm





6KG WN20-04

外 径	(Out-diameter): Φ 160mm
容 积	(Volume): 7.7L
瓶 高	(Cylinder Length): 440mm
瓶 重	(Cylinder Weight): 2Kg
灭火器重量	(Extinguisher Weight): 9Kg
灭火剂重量	(Dry Powder Filled Weight): 6Kg
温度范围	(Temperature Range): -30 $^{\circ}$ C-60 $^{\circ}$ C
最大工作压力	(Max Working Pressure): 18Bar
测试压力	(Test Pressure): 27Bar
最小壁厚	(Min Wall-thickness): 0.80mm
材 料	(Material): 304
灭火级别	(Fire Class): 27A 183B C
包装尺寸	(Packing Size): 17X18X54cm



9KG WN20-05

外 径	(Out-diameter): Φ 180mm
容 积	(Volume): 13.2L
瓶 高	(Cylinder Length): 500mm
瓶 重	(Cylinder Weight): 2.6Kg
灭火器重量	(Extinguisher Weight): 12.5Kg
灭火剂重量	(Dry Powder Filled Weight): 9Kg
温度范围	(Temperature Range): -30 $^{\circ}$ C-60 $^{\circ}$ C
最大工作压力	(Max Working Pressure): 18Bar
测试压力	(Test Pressure): 27Bar
最小壁厚	(Min Wall-thickness): 0.8mm
材 料	(Material): 304
灭火级别	(Fire Class): 34A 183B C
包装尺寸	(Packing Size): 19X20X62cm

6L WN21-01

外 径	(Out-diameter): Φ 160mm
容 积	(Volume): 8L
瓶 高	(Cylinder Length): 475mm
瓶 重	(Cylinder Weight): 3.3Kg
灭火器重量	(Extinguisher Weight): 11Kg
灭火剂重量	(Filling Weight): 6L
温度范围	(Temperature Range): 0°C-60°C
测试压力	(Test Pressure): 27Bar
最小壁厚	(Min Wall-thickness): 1.24mm
材 料	(Material): St12/DC01
灭火级别	(Fire Class): 21A 144B C
包装尺寸	(Packing Size): 17X18X59cm
内置小钢瓶	(Internal gas cartridge)
驱动气体	(Drive gas): CO2(55g)
材 料	(Material): St52



9L WN21-02

外 径	(Out-diameter): Φ 180mm
容 积	(Volume): 11.33L
瓶 高	(Cylinder Length): 530mm
瓶 重	(Cylinder Weight): 4.7Kg
灭火器重量	(Extinguisher Weight): 16Kg
灭火剂重量	(Filling Weight): 9L
温度范围	(Temperature Range): 0°C-60°C
测试压力	(Test Pressure): 27Bar
最小壁厚	(Min Wall-thickness): 1.3mm
材 料	(Material): St12/DC01
灭火级别	(Fire Class): 21A 183B C
包装尺寸	(Packing Size): 19X20X64cm
内置小钢瓶	(Internal gas cartridge)
驱动气体	(Drive gas): CO2(75g)
材 料	(Material): St52





6L WN22-01

外 径	(Out-diameter): Φ 160mm
容 积	(Volume): 7.7L
瓶 高	(Cylinder Length): 440mm
瓶 重	(Cylinder Weight): 2Kg
灭火器重量	(Extinguisher Weight): 9Kg
灭火剂重量	(Filling Weight): 6L
温度范围	(Temperature Range): 0°C-60°C
最大工作压力	(Max Working Pressure): 18Bar
测试压力	(Test Pressure): 27Bar
最小壁厚	(Min Wall-thickness): 0.80mm
材 料	(Material): 304
灭火级别	(Fire Class): 21A 144B C
包装尺寸	(Packing Size): 17X18X54cm



9L WN22-02

外 径	(Out-diameter): Φ 180mm
容 积	(Volume): 13.2L
瓶 高	(Cylinder Length): 500mm
瓶 重	(Cylinder Weight): 2.6Kg
灭火器重量	(Extinguisher Weight): 12.5Kg
灭火剂重量	(Filling Weight): 9L
温度范围	(Temperature Range): 0°C-60°C
最大工作压力	(Max Working Pressure): 18Bar
测试压力	(Test Pressure): 27Bar
最小壁厚	(Min Wall-thickness): 0.80mm
材 料	(Material): 304
灭火级别	(Fire Class): 21A 183B C
包装尺寸	(Packing Size): 19X20X62cm

10KG(双瓶 double cylinder) WN23-01

外 径	(Out-diameter): $\Phi 152\text{mm}$
容 积	(Volume): 15L
瓶 高	(Cylinder Length): 570mm
瓶 重	(Cylinder Weight): 25Kg
灭火器重量	(Extinguisher Weight): 50Kg
灭火剂重量	(Filling Weight): 10Kg
温 度 范 围	(Temperature Range): $-20^{\circ}\text{C} - 60^{\circ}\text{C}$
最大工作压力	(Max Working Pressure): 174Bar
测试压力	(Test Pressure): 250Bar
最小壁厚	(Min Wall-thickness): 5.5mm
材 料	(Material): CK45
灭 火 级 别	(Fire Class): 183B
外 形 尺 寸	(Size): 30X46X85cm



10KG(单瓶 single cylinder) WN23-02

外 径	(Out-diameter): $\Phi 152\text{mm}$
容 积	(Volume): 15L
瓶 高	(Cylinder Length): 1070mm
瓶 重	(Cylinder Weight): 25Kg
灭火器重量	(Extinguisher Weight): 46Kg
灭火剂重量	(Filling Weight): 10Kg
温 度 范 围	(Temperature Range): $-20^{\circ}\text{C} - 60^{\circ}\text{C}$
最大工作压力	(Max Working Pressure): 174Bar
测试压力	(Test Pressure): 250Bar
最小壁厚	(Min Wall-thickness): 5.5mm
材 料	(Material): CK45
灭 火 级 别	(Fire Class): 183B
外 形 尺 寸	(Size): 46X30X120cm





20KG WN23-03

外 径	(Out-diameter): Φ 219mm
容 积	(Volume): 33.5L
瓶 高	(Cylinder Length): 1160mm
瓶 重	(Cylinder Weight): 50Kg
灭火器重量	(Extinguisher Weight): 100Kg
灭火剂重量	(Filling Weight): 20Kg
温度范围	(Temperature Range): -30℃-55℃
最大工作压力	(Max Working Pressure): 150Bar
测试压力	(Test Pressure): 225Bar
最小壁厚	(Min Wall-thickness): 5.7mm
材 料	(Material): 37Mn
灭火级别	(Fire Class): 233B
外形尺寸	(Size): 102X48X122cm



25KG WN23-04

外 径	(Out-diameter): Φ 219mm
容 积	(Volume): 40L
瓶 高	(Cylinder Length): 1330mm
瓶 重	(Cylinder Weight): 56Kg
灭火器重量	(Extinguisher Weight): 110Kg
灭火剂重量	(Filling Weight): 25Kg
温度范围	(Temperature Range): -30℃-55℃
最大工作压力	(Max Working Pressure): 150Bar
测试压力	(Test Pressure): 225Bar
最小壁厚	(Min Wall-thickness): 5.7mm
材 料	(Material): 37Mn
灭火级别	(Fire Class): 233B
外形尺寸	(Size): 102X48X122cm

30KG WN23-5

外 径	(Out-diameter): Φ 232mm
容 积	(Volume): 46L
瓶 高	(Cylinder Length): 1370mm
瓶 重	(Cylinder Weight): 57Kg
灭火器重量	(Extinguisher Weight): 117Kg
灭火剂重量	(Filling Weight): 30Kg
温 度 范 围	(Temperature Range): -30°C-55°C
最大工作压力	(Max Working Pressure): 150Bar
测 试 压 力	(Test Pressure): 225Bar
最 小 壁 厚	(Min Wall-thickness): 5.4mm
材 料	(Material): 37Mn
灭 火 级 别	(Fire Class): 233B
外 形 尺 寸	(Size): 118X55X124cm



50KG(双瓶 double cylinder) WN23-6

外 径	(Out-diameter): Φ 219mm
容 积	(Volume): 80L
瓶 高	(Cylinder Length): 1330mm
瓶 重	(Cylinder Weight): 112Kg
灭火器重量	(Extinguisher Weight): 207Kg
灭火剂重量	(Filling Weight): 50Kg
温 度 范 围	(Temperature Range): -30°C-55°C
最大工作压力	(Max Working Pressure): 150Bar
测 试 压 力	(Test Pressure): 225Bar
最 小 壁 厚	(Min Wall-thickness): 5.7mm
材 料	(Material): 37Mn
灭 火 级 别	(Fire Class): 233B
外 形 尺 寸	(Size): 123X62X132cm





25KG WN24-01

外 径	(Out-diameter): $\Phi 270\text{mm}$
容 积	(Volume): 30L
瓶 高	(Cylinder Length): 625mm
瓶 重	(Cylinder Weight): 11Kg
灭火器重量	(Extinguisher Weight): 56Kg
灭火剂重量	(Dry Powder Filled Weight): 25Kg
温度范围	(Temperature Range): $-20^{\circ}\text{C}-55^{\circ}\text{C}$
工作压力	(Working Pressure): 15Bar
测试压力	(Test Pressure): 35Bar
最小壁厚	(Min Wall-thickness): 2.5mm
材 料	(Material): HP295/B440HP
灭火级别	(Fire Class): 55A B C
包装尺寸	(Packing Size): 58X47X97cm



50KG WN24-02

外 径	(Out-diameter): $\Phi 320\text{mm}$
容 积	(Volume): 59L
瓶 高	(Cylinder Length): 875mm
瓶 重	(Cylinder Weight): 21Kg
灭火器重量	(Extinguisher Weight): 95Kg
灭火剂重量	(Dry Powder Filled Weight): 50Kg
温度范围	(Temperature Range): $-20^{\circ}\text{C}-55^{\circ}\text{C}$
工作压力	(Working Pressure): 15Bar
测试压力	(Test Pressure): 35Bar
最小壁厚	(Min Wall-thickness): 3.0mm
材 料	(Material): HP295/B440HP
灭火级别	(Fire Class): 55A B C
包装尺寸	(Packing Size): 63X50X111cm

25KG WN25-01

外 径	(Out-diameter):	Φ270mm
容 积	(Volume):	30L
瓶 高	(Cylinder Length):	625mm
瓶 重	(Cylinder Weight):	20Kg
灭火器重量	(Extinguisher Weight):	55Kg
灭火剂重量	(Dry Powder Filled Weight):	25Kg
温 度 范 围	(Temperature Range):	-20℃-55℃
工 作 压 力	(Working Pressure):	15Bar
测 试 压 力	(Test Pressure):	35Bar
最 小 壁 厚	(Min Wall-thickness):	2.5mm
材 料	(Material):	HP295/B440HP
灭 火 级 别	(Fire Class):	55A I B C
包 装 尺 寸	(Packing Size):	44X45X95cm



50KG WN25-02

外 径	(Out-diameter):	Φ320mm
容 积	(Volume):	59L
瓶 高	(Cylinder Length):	875mm
瓶 重	(Cylinder Weight):	32Kg
灭火器重量	(Extinguisher Weight):	93Kg
灭火剂重量	(Dry Powder Filled Weight):	50Kg
温 度 范 围	(Temperature Range):	-20℃-55℃
工 作 压 力	(Working Pressure):	15Bar
测 试 压 力	(Test Pressure):	35Bar
最 小 壁 厚	(Min Wall-thickness):	3.0mm
材 料	(Material):	HP295/B440HP
灭 火 级 别	(Fire Class):	55A II B C
包 装 尺 寸	(Packing Size):	63X50X111cm



100KG WN25-03

外 径	(Out-diameter):	Φ406mm
容 积	(Volume):	124L
瓶 高	(Cylinder Length):	1100mm
瓶 重	(Cylinder Weight):	50Kg
灭火器重量	(Extinguisher Weight):	160Kg
灭火剂重量	(Dry Powder Filled Weight):	100Kg
温 度 范 围	(Temperature Range):	-20℃-55℃
工 作 压 力	(Working Pressure):	15Bar
测 试 压 力	(Test Pressure):	35Bar
最 小 壁 厚	(Min Wall-thickness):	3.0mm
材 料	(Material):	HP325/B490HP
灭 火 级 别	(Fire Class):	55A IIIB C
包 装 尺 寸	(Packing Size):	62X57X122cm





25KG WN26-01

外 容 瓶 重 量 (Out-diameter): Φ 270mm
 积 高 重 量 (Volume): 30L
 瓶 重 量 (Cylinder Length): 625mm
 灭 火 器 重 量 (Cylinder Weight): 20Kg
 灭 火 剂 重 量 (Extinguisher Weight): 60Kg
 重 量 (Dry Powder Filled Weight): 25Kg
 温 度 范 围 (Temperature Range): -20 $^{\circ}$ C-55 $^{\circ}$ C
 测 试 压 力 (Test Pressure): 35Bar
 最 小 壁 厚 (Min Wall-thickness): 2.5mm
 材 料 (Material): HP295/B440HP
 灭 火 级 别 (Fire Class): 55A I B C
 包 装 尺 寸 (Packing Size): 44X45X95cm

外 置 小 钢 瓶 (External gas cartridge)
 驱 动 气 体 (Drive gas): CO₂(0.67)Kg
 材 料 (Material): CK45



50KG WN26-02

外 容 瓶 重 量 (Out-diameter): Φ 320mm
 积 高 重 量 (Volume): 59L
 瓶 重 量 (Cylinder Length): 875mm
 灭 火 器 重 量 (Cylinder Weight): 32Kg
 灭 火 剂 重 量 (Extinguisher Weight): 100Kg
 重 量 (Dry Powder Filled Weight): 50Kg
 温 度 范 围 (Temperature Range): -20 $^{\circ}$ C-55 $^{\circ}$ C
 测 试 压 力 (Test Pressure): 35Bar
 最 小 壁 厚 (Min Wall-thickness): 3.0mm
 材 料 (Material): HP295/B440HP
 灭 火 级 别 (Fire Class): 55A II B C
 包 装 尺 寸 (Packing Size): 63X50X111cm

外 置 小 钢 瓶 (External gas cartridge)
 驱 动 气 体 (Drive gas): CO₂(1.25)Kg
 材 料 (Material): CK45



100KG WN26-03

外 容 瓶 重 量 (Out-diameter): Φ 406mm
 积 高 重 量 (Volume): 124L
 瓶 重 量 (Cylinder Length): 1100mm
 灭 火 器 重 量 (Cylinder Weight): 50Kg
 灭 火 剂 重 量 (Extinguisher Weight): 180Kg
 重 量 (Dry Powder Filled Weight): 100Kg
 温 度 范 围 (Temperature Range): -20 $^{\circ}$ C-55 $^{\circ}$ C
 测 试 压 力 (Test Pressure): 35Bar
 最 小 壁 厚 (Min Wall-thickness): 3.0mm
 材 料 (Material): HP325/B490HP
 灭 火 级 别 (Fire Class): 55A IIIB C
 包 装 尺 寸 (Packing Size): 61X52X112cm

外 置 小 钢 瓶 (External gas cartridge)
 驱 动 气 体 (Drive gas): CO₂(2.5)Kg
 材 料 (Material): CK45

25L WN27-01

外 径	(Out-diameter): $\Phi 270\text{mm}$
容 积	(Volume): 30L
瓶 高	(Cylinder Length): 625mm
瓶 重	(Cylinder Weight): 20Kg
灭火器重量	(Extinguisher Weight): 55Kg
灭火剂重量	(Filling Weight): 25Kg
温度范围	(Temperature Range): 0°C-55°C
工作压力	(Working Pressure): 15Bar
测试压力	(Test Pressure): 35Bar
最小壁厚	(Min Wall-thickness): 2.5mm
材 料	(Material): HP295/B440HP
灭火级别	(Fire Class): 55A I B C
包装尺寸	(Packing Size): 58X47X97cm



50L WN27-02

外 径	(Out-diameter): $\Phi 320\text{mm}$
容 积	(Volume): 59L
瓶 高	(Cylinder Length): 875mm
瓶 重	(Cylinder Weight): 32Kg
灭火器重量	(Extinguisher Weight): 95Kg
灭火剂重量	(Filling Weight): 50Kg
温度范围	(Temperature Range): 0°C-55°C
工作压力	(Max Working Pressure): 15Bar
测试压力	(Test Pressure): 35Bar
最小壁厚	(Min Wall-thickness): 3.0mm
材 料	(Material): HP295/B440HP
灭火级别	(Fire Class): 55A II B C
包装尺寸	(Packing Size): 63X50X111cm





25L WN28-01

外 径	(Out-diameter):	Φ270mm
容 积	(Volume):	30L
瓶 高	(Cylinder Length):	625mm
瓶 重	(Cylinder Weight):	20Kg
灭火器重量	(Extinguisher Weight):	55Kg
灭火剂重量	(Filling Weight):	25Kg
温 度 范 围	(Temperature Range):	0℃-55℃
工 作 压 力	(Working Pressure):	15Bar
测 试 压 力	(Test Pressure):	35Bar
最 小 壁 厚	(Min Wall-thickness):	2.5mm
材 料	(Material):	HP295/B440HP
灭 火 级 别	(Fire Class):	55A I B C
包 装 尺 寸	(Packing Size):	44X45X95cm



100L WN28-02

外 径	(Out-diameter):	Φ406mm
容 积	(Volume):	124L
瓶 高	(Cylinder Length):	1100mm
瓶 重	(Cylinder Weight):	50Kg
灭火器重量	(Extinguisher Weight):	160Kg
灭火剂重量	(Filling Weight):	100Kg
温 度 范 围	(Temperature Range):	0℃-55℃
工 作 压 力	(Working Pressure):	15Bar
测 试 压 力	(Test Pressure):	35Bar
最 小 壁 厚	(Min Wall-thickness):	3.0mm
材 料	(Material):	HP325/B490HP
灭 火 级 别	(Fire Class):	55A IIIB C
包 装 尺 寸	(Packing Size):	62X57X122cm

25L WN29-01

外 容 瓶 重 量 (Out-diameter): Φ 270mm
 瓶 积 高 (Volume): 30L
 重 量 (Cylinder Length): 625mm
 灭 火 器 重 量 (Cylinder Weight): 20Kg
 灭 火 剂 重 量 (Extinguisher Weight): 60Kg
 温 度 范 围 (Filling Weight): 25Kg
 测 试 压 力 (Temperature Range): 0°C-55°C
 最 小 壁 厚 (Test Pressure): 35Bar
 材 料 (Min Wall-thickness): 2.5mm
 灭 火 级 别 (Material): HP295/B440HP
 包 装 尺 寸 (Fire Class): 55A I B C
 (Packing Size): 43X46X95cm

外 置 小 钢 瓶 (External gas cartridge)
 驱 动 气 体 (Drive gas 9MPa): N₂(2)L
 材 料 (Material): CK45

50L WN29-02

外 容 瓶 重 量 (Out-diameter): Φ 320mm
 瓶 积 高 (Volume): 59L
 重 量 (Cylinder Length): 875mm
 灭 火 器 重 量 (Cylinder Weight): 32Kg
 灭 火 剂 重 量 (Extinguisher Weight): 100Kg
 温 度 范 围 (Filling Weight): 50Kg
 测 试 压 力 (Temperature Range): 0°C-55°C
 最 小 壁 厚 (Test Pressure): 35Bar
 材 料 (Min Wall-thickness): 3.0mm
 灭 火 级 别 (Material): HP295/B440HP
 包 装 尺 寸 (Fire Class): 55A II B C
 (Packing Size): 53X48X98cm

外 置 小 钢 瓶 (External gas cartridge)
 驱 动 气 体 (Drive gas 9MPa): N₂(2.5)L
 材 料 (Material): CK45

100L WN29-03

外 容 瓶 重 量 (Out-diameter): Φ 406mm
 瓶 积 高 (Volume): 124L
 重 量 (Cylinder Length): 1100mm
 灭 火 器 重 量 (Cylinder Weight): 50Kg
 灭 火 剂 重 量 (Extinguisher Weight): 180Kg
 温 度 范 围 (Filling Weight): 100Kg
 测 试 压 力 (Temperature Range): 0°C-55°C
 最 小 壁 厚 (Test Pressure): 35Bar
 材 料 (Min Wall-thickness): 3.0mm
 灭 火 级 别 (Material): HP325/B490HP
 包 装 尺 寸 (Fire Class): 55A III B C
 (Packing Size): 60X71X112cm

外 置 小 钢 瓶 (External gas cartridge)
 驱 动 气 体 (Drive gas 9MPa): N₂(3.7)L
 材 料 (Material): CK45



外置小钢瓶 EXTERNAL CO2 CARTRIDGE

规格 TYPE	250G	300G	350G
产品编号 Item No.	WN30-01	WN30-02	WN30-03
外径 Out-diameter(mm)	Φ51	Φ51	Φ51
容积 Volume(ml)	375	450	525
充装量 CO2 Filled Weight(g)	250	300	350
瓶体长度 Cylinder Length(mm)	280	330	390
工作压力 Working Pressure(Bar)	174	174	174
测试压力 Test Pressure(Bar)	250	250	250
最小壁厚 Min Wall-thickness(mm)	3	3	3
材料 Material	20#	20#	20#

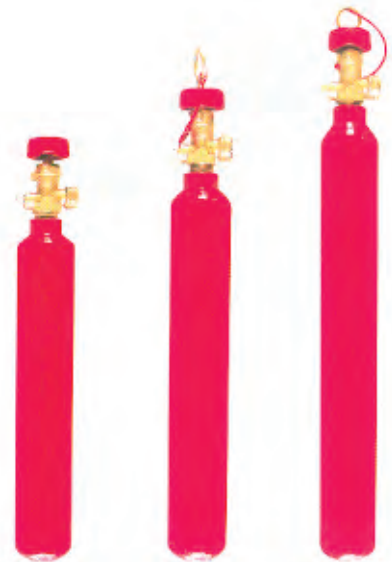

内置小钢瓶 INTERNAL CO2 CARTRIDGE

规格 TYPE	55G	75G	120G	180G	225G
产品编号 Item No.	WN31-01	WN31-02	WN31-03	WN31-04	WN31-05
外径 Out-diameter(mm)	Φ30	Φ38	Φ38	Φ40	Φ40
容积 Volume(ml)	83	113	180	270	338
充装量 CO2 Filled Weight(g)	55	75	120	180	225
瓶体长度 Cylinder Length(mm)	200	170	245	320	385
工作压力 Working Pressure(Bar)	174	174	174	174	174
测试压力 Test Pressure(Bar)	250	250	250	250	250
最小壁厚 Min Wall-thickness(mm)	2	2	2	2	2
材料 Material	20#	20#	20#	20#	20#





TY0036

规格 TYPE	55G	75G	120G	150G	225G
产品编号 Item No.	WN32-01	WN32-02	WN32-03	WN32-04	WN32-05
外径 Out diameter(mm)	Φ28	Φ28	Φ35	Φ35	Φ40
容积 Volume(ml)	74	100	160	200	300
充装量 CO2 Filled Weight(g)	50	75	120	150	210
瓶体长度 Cylinder Length(mm)	208	267	255	305	375
工作压力 Working Pressure(Bar)	193	193	193	193	193
测试压力 Test Pressure(Bar)	250	250	250	250	250
最小壁厚 Min Wall-thickness(mm)	2	2	2	2	2
材料 Material	20#	20#	20#	20#	20#

CO2 HORN 二氧化碳喷具总成



WN33-01



WN33-02



WN33-03

WN33-04

WN33-05

CO2 HOSE & HORN 二氧化碳灭火器喷具总成



WN34-01



WN34-02



WN34-03



WN34-04



WN34-05

DRY POWDER HOSE & HORN 干粉灭火器喷具总成



WN35-01



WN35-02



WN35-03



WN35-04

DRY POWDER HOSE & HORN 干粉灭火器喷嘴总成



FORM HOSE & HORN 轻水灭火器喷嘴总成



CO2 FIXATION CIRCLER 二氧化碳灭火器固定圈



DRY POWDER BRACKET 干粉灭火器挂具

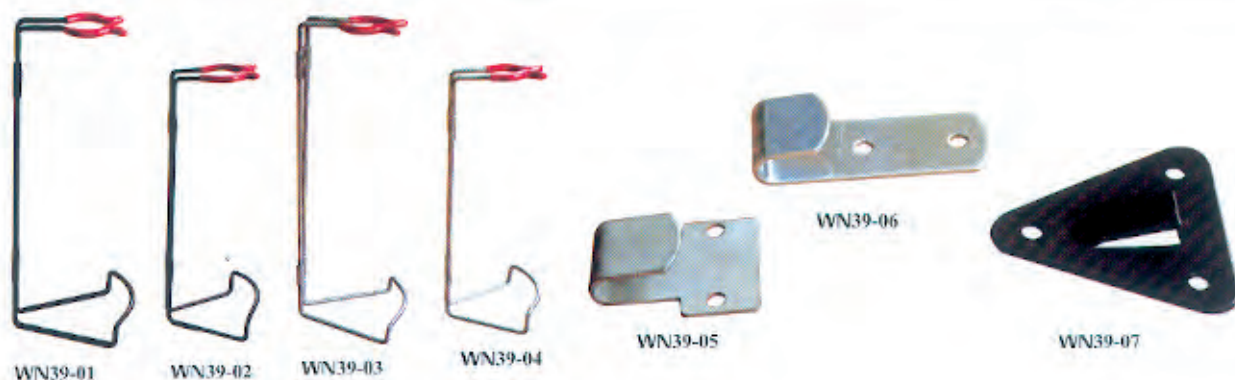

CO2 BRACKET 二氧化碳灭火器挂具

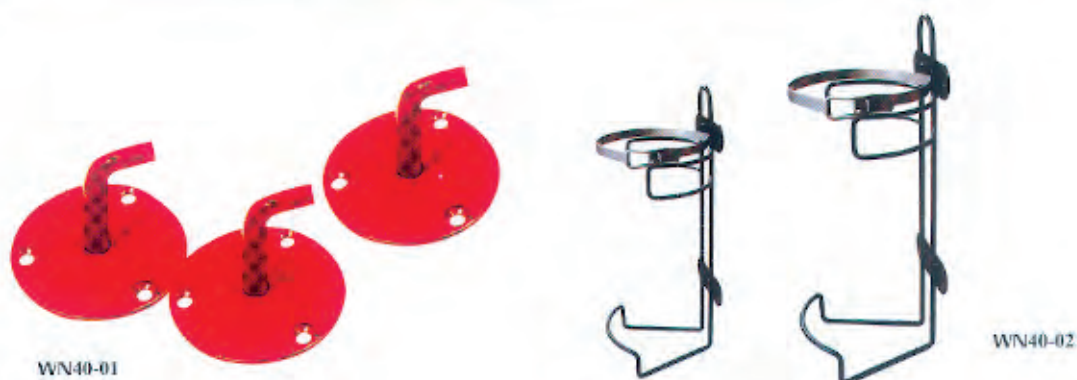

CO2 BRACKET 二氧化碳灭火器挂具



GAUGE 压力表



WN41-01



WN41-02



WN41-03



WN41-04

BASE PLASTIC 灭火器底座



WN42-01



WN42-02



WN42-03



WN42-04

JACKET 护罩



WN43-01



WN43-02

SPRAY GUN 喷枪总成



WN44-01



WN44-02

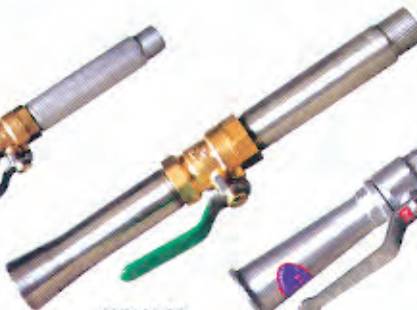

WN44-03



WN44-04

SIPHON 虹吸管
WN45-01



SEAL 塑封
WN46-01

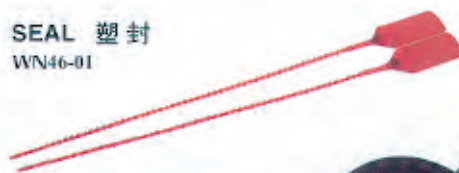

WHEEL 车轮
WN47-01



FIRE BLANKET 灭火毯
WN48-01



WN49-01



WN49-02

NOZZLE 喷嘴



WN49-03



WN49-04

WN50-01

- 瓶口连接螺纹 (INLET THERAD): M24X1.5
 喷口连接螺纹 (OUTLET THERAD): G1/4X19
 装表连接螺纹 (GAUGE CONNECTION THERAD): NPT1/8X27
 虹吸管连接螺纹 (DIP TUBE THERAD): M16X1.5
 超压释放压力 (PRESSURE MPA): 2.3-2.8

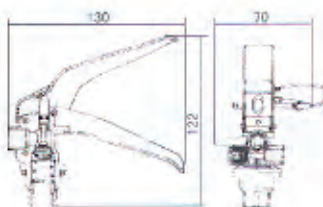

WN50-02

- 瓶口连接螺纹 (INLET THERAD): M24X1.5
 喷口连接螺纹 (OUTLET THERAD): G1/4X19
 装表连接螺纹 (GAUGE CONNECTION THERAD): NPT1/8X27
 虹吸管连接螺纹 (DIP TUBE THERAD): M16X1.5
 超压释放压力 (PRESSURE MPA): 2.3-2.8

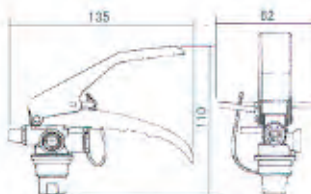

WN50-03

- 瓶口连接螺纹 (INLET THERAD): M25X1.5
 喷口连接螺纹 (OUTLET THERAD): M12X1.5
 装表连接螺纹 (GAUGE CONNECTION THERAD): M10X1
 虹吸管连接螺纹 (DIP TUBE THERAD): M18X1.5

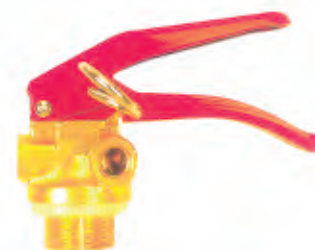
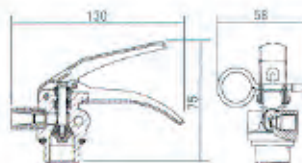

WN50-04

- 瓶口连接螺纹 (INLET THERAD): M30X1.5
 喷口连接螺纹 (OUTLET THERAD): G1/8X28
 装表连接螺纹 (GAUGE CONNECTION THERAD): NPT1/8X27
 虹吸管连接螺纹 (DIP TUBE THERAD): M16X1.5
 超压释放压力 (PRESSURE MPA): 2.3-2.8
 用气门芯或密封芯 (CHECK VALVE): 气门芯

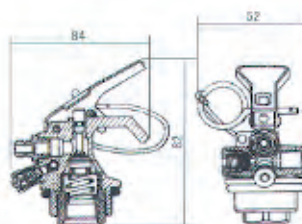

WN50-05

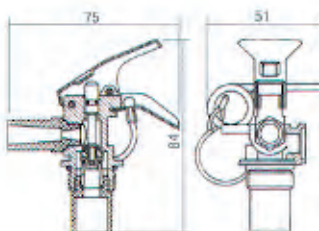

- 瓶口连接螺纹 (INLET THERAD): PF1/2X14
 喷口连接螺纹 (OUTLET THERAD): M10X1
 装表连接螺纹 (GAUGE CONNECTION THERAD): G1/8X28
 虹吸管连接螺纹 (DIP TUBE THERAD): M14X1.5

WN50-06

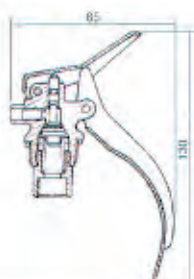

- 瓶口连接螺纹 (INLET THERAD): M22X1.5
 喷口连接螺纹 (OUTLET THERAD): $\Phi 3$
 装表连接螺纹 (GAUGE CONNECTION THERAD): M8X1
 虹吸管连接螺纹 (DIP TUBE THERAD): M10X1

WN50-07

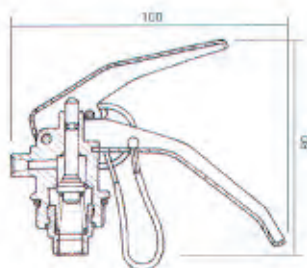

- 瓶口连接螺纹 (INLET THERAD): M22X1.5
 喷口连接螺纹 (OUTLET THERAD): $\Phi 3$
 装表连接螺纹 (GAUGE CONNECTION THERAD): NPT1/8X27
 虹吸管连接螺纹 (DIP TUBE THERAD): M10X1

WN50-08

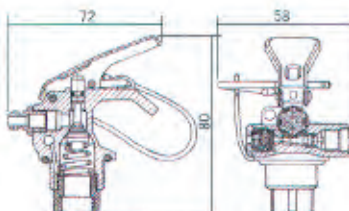

- 瓶口连接螺纹 (INLET THERAD): M24X1.5
 喷口连接螺纹 (OUTLET THERAD): G1/8X28
 装表连接螺纹 (GAUGE CONNECTION THERAD): M10X1X12.5
 虹吸管连接螺纹 (DIP TUBE THERAD): M16X1.5
 超压释放压力 (PRESSURE MPA): 2.3-2.8
 用气门芯或密封芯 (CHECK VALVE): 气门芯

WN50-09 CE0036

- 瓶口连接螺纹 (INLET THERAD): M30X1.5
 喷口连接螺纹 (OUTLET THERAD): G1/8X28
 装表连接螺纹 (GAUGE CONNECTION THERAD): M10X1X12.5
 虹吸管连接螺纹 (DIP TUBE THERAD): M16X1.5
 超压释放压力 (PRESSURE MPA): 2.3-2.8
 用气门芯或密封芯 (CHECK VALVE): 气门芯

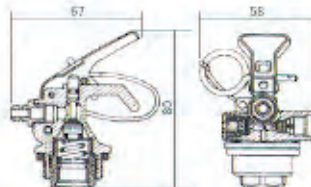

WN50-10 CE0036

- 瓶口连接螺纹 (INLET THERAD): M30X1.5
 喷口连接螺纹 (OUTLET THERAD): G1/8X28
 装表连接螺纹 (GAUGE CONNECTION THERAD): NPT1/8X27
 虹吸管连接螺纹 (DIP TUBE THERAD): M16X1.5
 超压释放压力 (PRESSURE MPA): 2.3-2.8

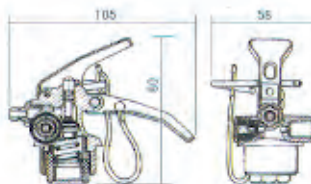

WN50-11

- 瓶口连接螺纹 (INLET THERAD): M30X1.5
 喷口连接螺纹 (OUTLET THERAD): G1/8X28
 装表连接螺纹 (GAUGE CONNECTION THERAD): M10X1X12.5
 虹吸管连接螺纹 (DIP TUBE THERAD): M16X1
 超压释放压力 (PRESSURE MPA): 2.3-2.8
 用气门芯或密封芯 (CHECK VALVE): 气门芯

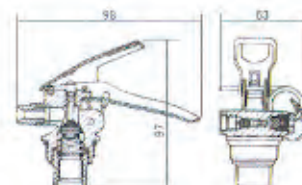

WN50-12

- 瓶口连接螺纹 (INLET THERAD): M24X1.5
 喷口连接螺纹 (OUTLET THERAD): M12X1.5
 装表连接螺纹 (GAUGE CONNECTION THERAD): M8X1
 虹吸管连接螺纹 (DIP TUBE THERAD): M14X1.5

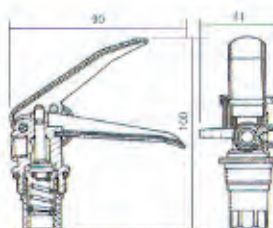

WN50-13

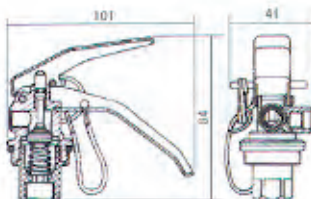

- 瓶口连接螺纹 (INLET THERAD): M30X1.5
 喷口连接螺纹 (OUTLET THERAD): M10X1.25
 装表连接螺纹 (GAUGE CONNECTION THERAD): M10X1X1.25
 虹吸管连接螺纹 (DIP TUBE THERAD): M16X1.5

WN50-14

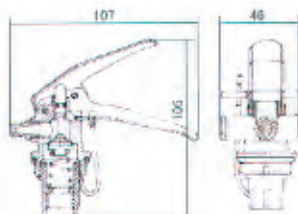

- 瓶口连接螺纹 (INLET THERAD): M30X1.5
 喷口连接螺纹 (OUTLET THERAD): M10X1
 装表连接螺纹 (GAUGE CONNECTION THERAD): NPT1/8X27
 虹吸管连接螺纹 (DIP TUBE THERAD): M16X1.5
 超压释放压力 (PRESSURE MPA): 2.3-2.8

WN51-01

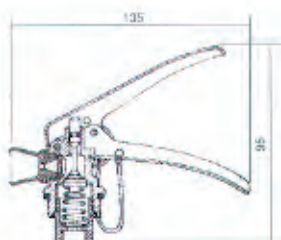

- 瓶口连接螺纹 (INLET THERAD): M30X1.5
 喷口连接螺纹 (OUTLET THERAD): M16X1.5
 装表连接螺纹 (GAUGE CONNECTION THERAD): M8X1
 虹吸管连接螺纹 (DIP TUBE THERAD): M16X1.5

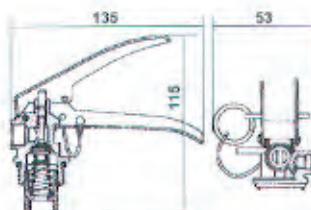
WN51-02  CE0036

- 瓶口连接螺纹 (INLET THERAD): M30X1.5
 喷口连接螺纹 (OUTLET THERAD): M14X1.5
 装表连接螺纹 (GAUGE CONNECTION THERAD): M10X1X1.25
 虹吸管连接螺纹 (DIP TUBE THERAD): M16X1.5

WN51-03

- 瓶口连接螺纹 (INLET THERAD): M45X1.5
 喷口连接螺纹 (OUTLET THERAD): M16X1.5
 装表连接螺纹 (GAUGE CONNECTION THERAD): M10X1X12.5
 虹吸管连接螺纹 (DIP TUBE THERAD): M16X1.5

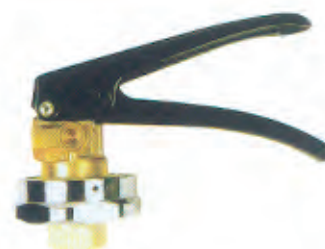
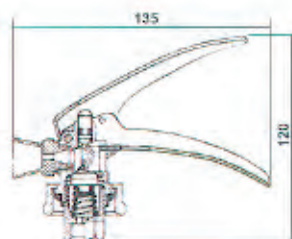

WN51-04

- 瓶口连接螺纹 (INLET THERAD): PF7/8-14
 喷口连接螺纹 (OUTLET THERAD): PF1/4-19
 装表连接螺纹 (GAUGE CONNECTION THERAD): PF1/8-28
 虹吸管连接螺纹 (DIP TUBE THERAD): M14X1.5

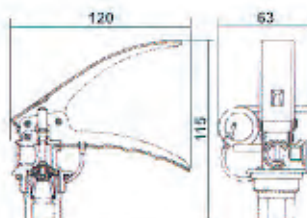

WN51-05

- 瓶口连接螺纹 (INLET THERAD): 1 1/8X12UN
 喷口连接螺纹 (OUTLET THERAD): 3/8X24UNF
 装表连接螺纹 (GAUGE CONNECTION THERAD): NPT1/8X27
 虹吸管连接螺纹 (DIP TUBE THERAD): M16X1.5

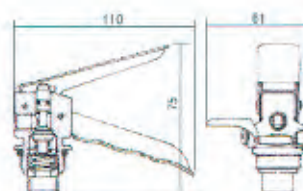

WN51-06

- 瓶口连接螺纹 (INLET THERAD): M30X1.5
 喷口连接螺纹 (OUTLET THERAD): G1/4X19
 装表连接螺纹 (GAUGE CONNECTION THERAD): M10X1X12.5
 虹吸管连接螺纹 (DIP TUBE THERAD): M16X1.5
 超压释放压力 (PRESSURE MPA): 2.3-2.8
 用气门芯或密封芯 (CHECK VALVE): 气门芯

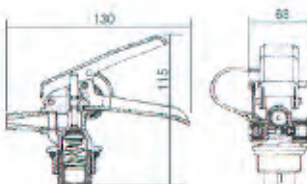

WN51-07

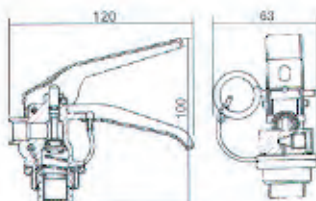

- 瓶口连接螺纹 (INLET THERAD): M30X1.5
 喷口连接螺纹 (OUTLET THERAD): G1/4X19
 装表连接螺纹 (GAUGE CONNECTION THERAD): M16X1.5
 虹吸管连接螺纹 (DIP TUBE THERAD): M18X1.5

WN51-08

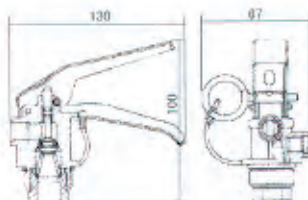

- 瓶口连接螺纹 (INLET THERAD): M30X1.5
 喷口连接螺纹 (OUTLET THERAD): G1/4X19
 装表连接螺纹 (GAUGE CONNECTION THERAD): M10X1X12.5
 虹吸管连接螺纹 (DIP TUBE THERAD): M15X1.5

WN51-09

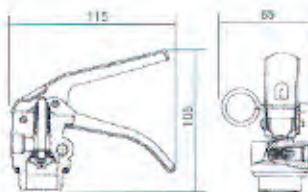
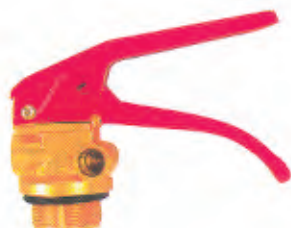

- 瓶口连接螺纹 (INLET THERAD): M30X1.5
 喷口连接螺纹 (OUTLET THERAD): M14X1 25
 装表连接螺纹 (GAUGE CONNECTION THERAD): M10X1X12.5
 虹吸管连接螺纹 (DIP TUBE THERAD): M16X1.5
 用气芯或密封芯 (CHECK VALVE): 气门芯

WN51-10

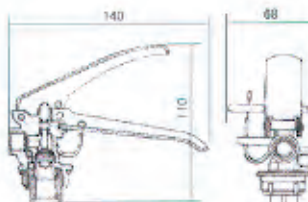

- 瓶口连接螺纹 (INLET THERAD): M30X1.5
 喷口连接螺纹 (OUTLET THERAD): G1/4X19
 装表连接螺纹 (GAUGE CONNECTION THERAD): NPT1/8X27
 虹吸管连接螺纹 (DIP TUBE THERAD): M16X1

WN51-11

- 瓶口连接螺纹 (INLET THERAD): M30X1.5
 喷口连接螺纹 (OUTLET THERAD): G1/4X19
 装表连接螺纹 (GAUGE CONNECTION THERAD): NPT1/8X27
 虹吸管连接螺纹 (DIP TUBE THERAD): M16X1.5
 超压释放压力 (PRESSURE MPA): 2.3-2.8
 用气门芯或密封芯 (CHECK VALVE): 气门芯

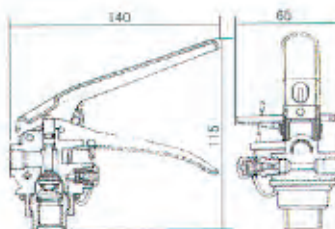
WN51-12  CE0036

- 瓶口连接螺纹 (INLET THERAD): M30X1.5
 喷口连接螺纹 (OUTLET THERAD): G1/4X19
 装表连接螺纹 (GAUGE CONNECTION THERAD): M10X1X12.5
 虹吸管连接螺纹 (DIP TUBE THERAD): M16X1.5
 超压释放压力 (PRESSURE MPA): 2.3-2.8
 用气门芯或密封芯 (CHECK VALVE): 气门芯

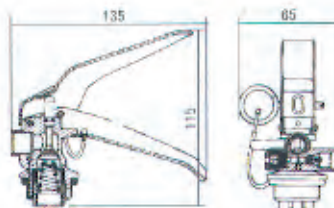

WN51-13

- 瓶口连接螺纹 (INLET THERAD): M30X1.5
 喷口连接螺纹 (OUTLET THERAD): G1/4X19
 装表连接螺纹 (GAUGE CONNECTION THERAD): M10X1X12.5
 虹吸管连接螺纹 (DIP TUBE THERAD): M16X1.5
 超压释放压力 (PRESSURE MPA): 2.3-2.8
 用气门芯或密封芯 (CHECK VALVE): 气门芯

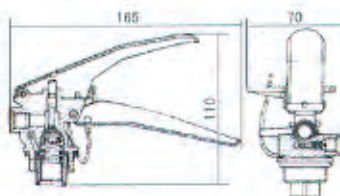
WN51-14  CE0036

- 瓶口连接螺纹 (INLET THERAD): M30X1.5
 喷口连接螺纹 (OUTLET THERAD): G1/4X19
 装表连接螺纹 (GAUGE CONNECTION THERAD): NPT1/8X27
 虹吸管连接螺纹 (DIP TUBE THERAD): M16X1.5
 超压释放压力 (PRESSURE MPA): 2.3-2.8
 用气门芯或密封芯 (CHECK VALVE): 气门芯

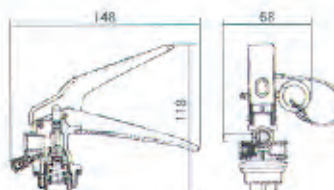

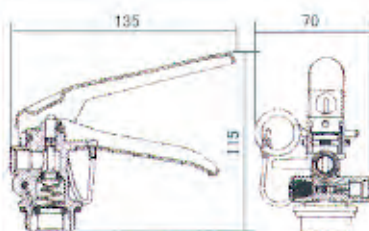
WN51-15  CE0036

瓶口连接螺纹 (INLET THERAD): M30X1.5
 喷口连接螺纹 (OUTLET THERAD): G1/4X19
 装表连接螺纹 (GAUGE CONNECTION THERAD): M10X1X12.5
 虹吸管连接螺纹 (DIP TUBE THERAD): M18X1.5
 超压释放压力 (PRESSURE MPA): 2.3-2.8
 用气门芯或密封芯 (CHECK VALVE): 气门芯

WN51-16

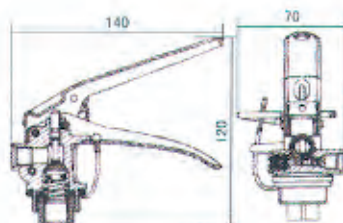

瓶口连接螺纹 (INLET THERAD): M30X1.5
 喷口连接螺纹 (OUTLET THERAD): G1/4X19
 装表连接螺纹 (GAUGE CONNECTION THERAD): M10X1X12.5
 虹吸管连接螺纹 (DIP TUBE THERAD): M16X1.5
 超压释放压力 (PRESSURE MPA): 2.3-2.8
 用气门芯或密封芯 (CHECK VALVE): 气门芯

WN51-17

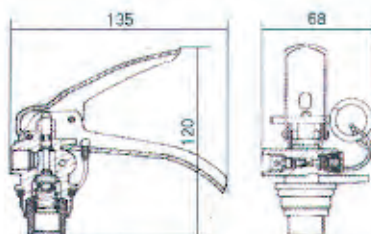

瓶口连接螺纹 (INLET THERAD): M30X1.5
 喷口连接螺纹 (OUTLET THERAD): G1/4X19
 装表连接螺纹 (GAUGE CONNECTION THERAD): M10X1X12.5
 虹吸管连接螺纹 (DIP TUBE THERAD): M16X1
 超压释放压力 (PRESSURE MPA): 2.3-2.8
 用气门芯或密封芯 (CHECK VALVE): 气门芯

WN51-18

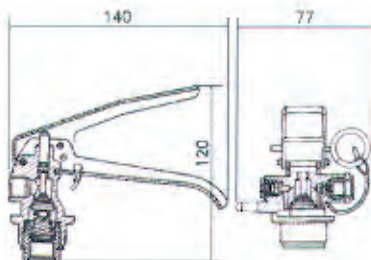

瓶口连接螺纹 (INLET THERAD): M30X1.5
 喷口连接螺纹 (OUTLET THERAD): M14X1.5
 装表连接螺纹 (GAUGE CONNECTION THERAD): M10X1X12.5
 虹吸管连接螺纹 (DIP TUBE THERAD): M16X1
 超压释放压力 (PRESSURE MPA): 2.3-2.8
 用气门芯或密封芯 (CHECK VALVE): 气门芯

WN51-19

- 瓶口连接螺纹 (INLET THERAD): M30X1.5
 喷口连接螺纹 (OUTLET THERAD): M14X1.5
 装表连接螺纹 (GAUGE CONNECTION THERAD): NPT1/8X27
 虹吸管连接螺纹 (DIP TUBE THERAD): M16X1.5
 超压释放压力 (PRESSURE MPA): 2.3-2.8

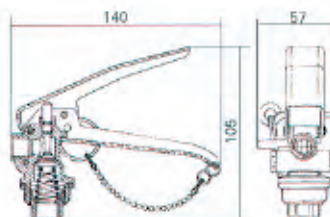

WN52-01 CE0036

- 瓶口连接螺纹 (INLET THERAD): M25X2
 喷口连接螺纹 (OUTLET THERAD): $\Phi 21.7 \times 14$
 虹吸管连接螺纹 (DIP TUBE THERAD): G1/4X19
 超压释放压力 (PRESSURE MPA): 18-22

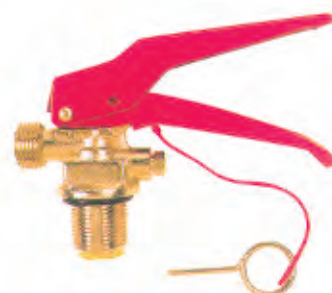
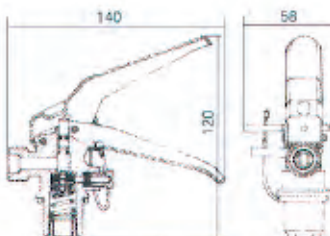

WN52-02

- 瓶口连接螺纹 (INLET THERAD): M25X2
 喷口连接螺纹 (OUTLET THERAD): $\Phi 21.7 \times 14$
 虹吸管连接螺纹 (DIP TUBE THERAD): G1/8X28
 超压释放压力 (PRESSURE MPA): 18-22

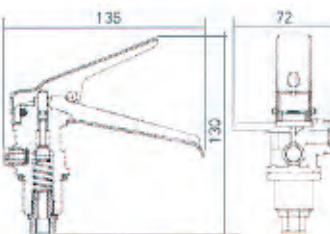

WN52-03

- 瓶口连接螺纹 (INLET THERAD): M25X2
 喷口连接螺纹 (OUTLET THERAD): M16X1.5
 虹吸管连接螺纹 (DIP TUBE THERAD): M10X1
 超压释放压力 (PRESSURE MPA): 18-22

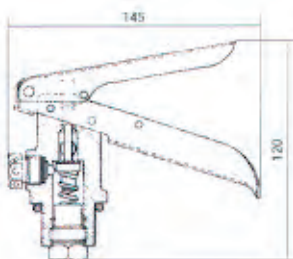

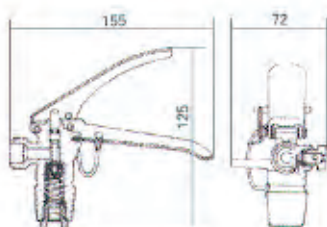
WN52-04  CE 0036

瓶口连接螺纹 (INLET THERAD): PZ27.8X14
 喷口连接螺纹 (OUTLET THERAD): $\phi 21.7 \times 14$
 虹吸管连接螺纹 (DIP TUBE THERAD): M10X1
 超压释放压力 (PRESSURE MPA): 18-22

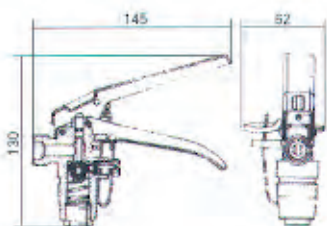
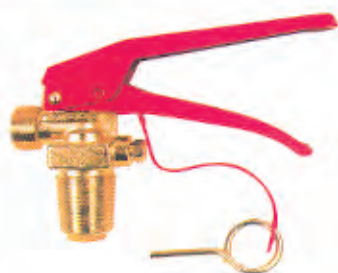
WN52-05  CE 0036

瓶口连接螺纹 (INLET THERAD): PZ27.8X14
 喷口连接螺纹 (OUTLET THERAD): $\phi 21.7 \times 14$
 虹吸管连接螺纹 (DIP TUBE THERAD): G1/4X19
 超压释放压力 (PRESSURE MPA): 18-22

WN52-06

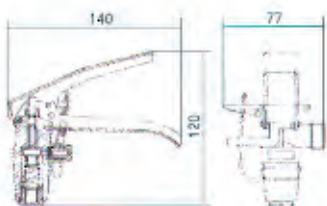

瓶口连接螺纹 (INLET THERAD): PZ27.8X14
 喷口连接螺纹 (OUTLET THERAD): $\phi 21.7 \times 14$
 虹吸管连接螺纹 (DIP TUBE THERAD): G1/4X19
 超压释放压力 (PRESSURE MPA): 18-22

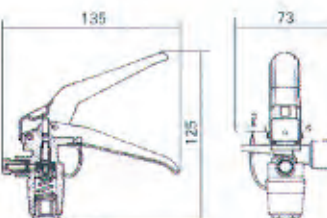
WN52-07  CE 0036

瓶口连接螺纹 (INLET THERAD): PZ27.8X14
 喷口连接螺纹 (OUTLET THERAD): $\phi 21.7 \times 14$
 虹吸管连接螺纹 (DIP TUBE THERAD): M10X1
 超压释放压力 (PRESSURE MPA): 18-22

WN52-08

瓶口连接螺纹 (INLET THERAD): PZ27.8X14
 喷口连接螺纹 (OUTLET THERAD): $\Phi 21.7 \times 14$
 虹吸管连接螺纹 (DIP TUBE THERAD): M10X1
 超压释放压力 (PRESSURE MPA): 18-22

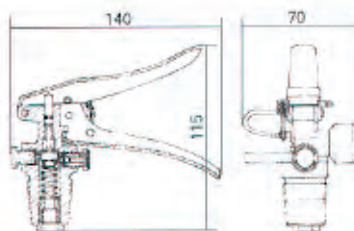

WN52-09 CE0036

瓶口连接螺纹 (INLET THERAD): PZ27.8X14
 喷口连接螺纹 (OUTLET THERAD): $\Phi 21.7 \times 14$
 虹吸管连接螺纹 (DIP TUBE THERAD): M10X1
 超压释放压力 (PRESSURE MPA): 18-22

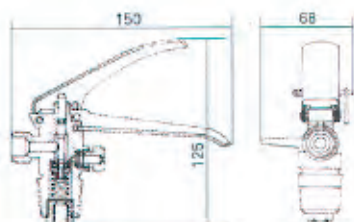

WN52-10

瓶口连接螺纹 (INLET THERAD): PZ27.8X14
 喷口连接螺纹 (OUTLET THERAD): $\Phi 21.7 \times 14$
 虹吸管连接螺纹 (DIP TUBE THERAD): G1/4X19
 超压释放压力 (PRESSURE MPA): 18-22

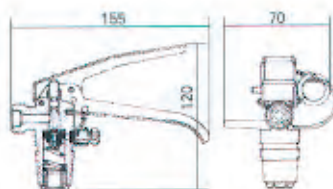

WN52-11

瓶口连接螺纹 (INLET THERAD): PZ27.8X14
 喷口连接螺纹 (OUTLET THERAD): $\Phi 21.7 \times 14$
 虹吸管连接螺纹 (DIP TUBE THERAD): M10X1
 超压释放压力 (PRESSURE MPA): 18-22

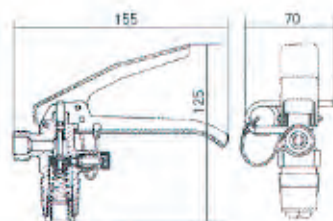

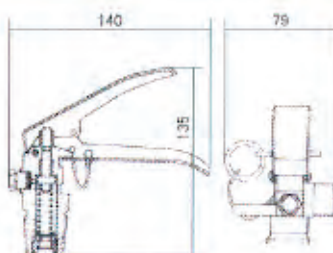
WN52-12  CE0036

瓶口连接螺纹 (INLET THERAD): PZ27.8X14
 喷口连接螺纹 (OUTLET THERAD): $\Phi 21.7 \times 14$
 虹吸管连接螺纹 (DIP TUBE THERAD): M10X1
 超压释放压力 (PRESSURE MPA): 18-22

WN52-13

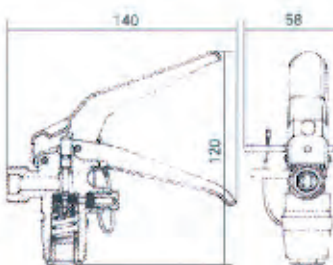

瓶口连接螺纹 (INLET THERAD): PZ19.2X14
 喷口连接螺纹 (OUTLET THERAD): $\Phi 21.7 \times 14$
 虹吸管连接螺纹 (DIP TUBE THERAD): M10X1
 超压释放压力 (PRESSURE MPA): 18-22

WN52-14

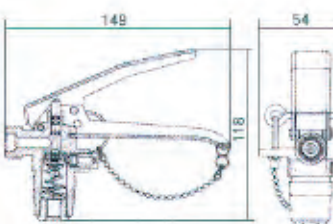

瓶口连接螺纹 (INLET THERAD): PZ27.8X14
 喷口连接螺纹 (OUTLET THERAD): $\Phi 21.7 \times 14$
 虹吸管连接螺纹 (DIP TUBE THERAD): G1/4X19
 超压释放压力 (PRESSURE MPA): 18-22

WN52-15

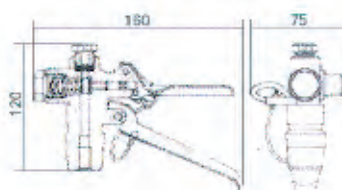

瓶口连接螺纹 (INLET THERAD): PZ27.8X14
 喷口连接螺纹 (OUTLET THERAD): NPT3/8X18
 虹吸管连接螺纹 (DIP TUBE THERAD): M10X1
 超压释放压力 (PRESSURE MPA): 18-22

WN52-16

瓶口连接螺纹 (INLET THERAD): PZ19.2X14
 喷口连接螺纹 (OUTLET THERAD): $\Phi 21.7 \times 14$
 虹吸管连接螺纹 (DIP TUBE THERAD): M10X1
 超压释放压力 (PRESSURE MPA): 18-22

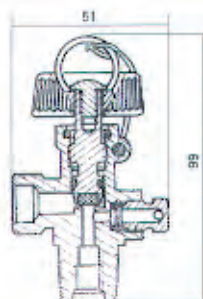

WN52-17

瓶口连接螺纹 (INLET THERAD): PZ27.8X14
 喷口连接螺纹 (OUTLET THERAD): $\Phi 21.7 \times 14$
 虹吸管连接螺纹 (DIP TUBE THERAD): M10X1
 超压释放压力 (PRESSURE MPA): 18-22

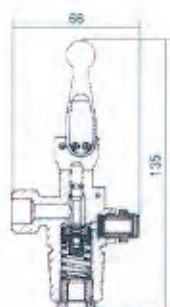

WN52-18

瓶口连接螺纹 (INLET THERAD): PZ27.8X14
 喷口连接螺纹 (OUTLET THERAD): $\Phi 21.7 \times 19$
 虹吸管连接螺纹 (DIP TUBE THERAD): G1/4X19
 超压释放压力 (PRESSURE MPA): 18-22

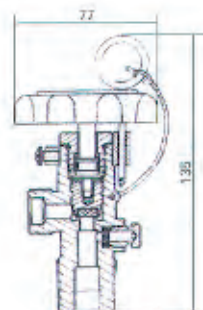

WN52-19

瓶口连接螺纹 (INLET THERAD): PZ27.8X14
 喷口连接螺纹 (OUTLET THERAD): $\Phi 21.7 \times 14$
 虹吸管连接螺纹 (DIP TUBE THERAD): M10X1
 超压释放压力 (PRESSURE MPA): 18-22

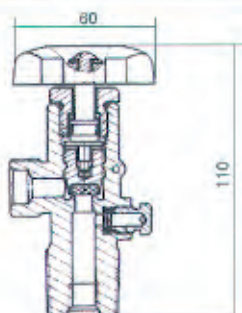

WN53-01

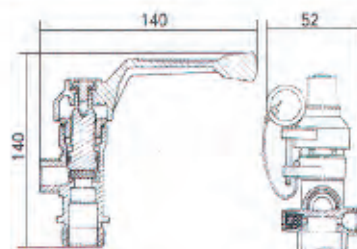

- 瓶口连接螺纹 (INLET THERAD): 1" BSP
 喷口连接螺纹 (OUTLET THERAD): 1/2" BSP
 装表连接螺纹 (GAUGE CONNECTION THERAD): NPT1/8-27
 虹吸管连接螺纹 (DIP TUBE THERAD): M24X1.5
 超压释放压力 (PRESSURE MPA): 2.3-2.8

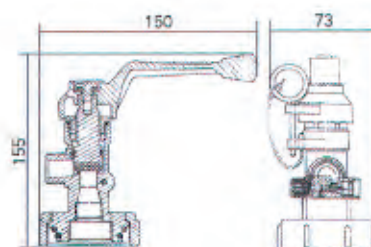
WN53-02  CE0036

- 瓶口连接螺纹 (INLET THERAD): 2" BSP
 喷口连接螺纹 (OUTLET THERAD): 3/4 BSP
 装表连接螺纹 (GAUGE CONNECTION THERAD): M10X1X12.5
 虹吸管连接螺纹 (DIP TUBE THERAD): 3/4 BSP
 超压释放压力 (PRESSURE MPA): 2.3-2.8
 用气门芯或密封芯 (CHECK VALVE): 气门芯

WN53-03

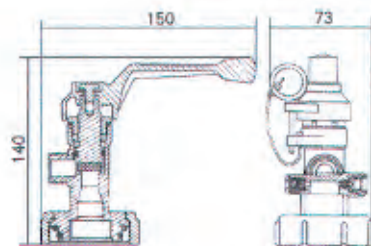

- 瓶口连接螺纹 (INLET THERAD): 2" BSP
 喷口连接螺纹 (OUTLET THERAD): 1/2" BSP
 装表连接螺纹 (GAUGE CONNECTION THERAD): NPT1/8-27
 虹吸管连接螺纹 (DIP TUBE THERAD): 3/4 BSP
 超压释放压力 (PRESSURE MPA): 2.3-2.8

WN53-04

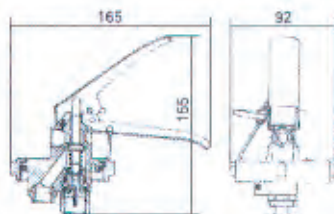

- 瓶口连接螺纹 (INLET THERAD): M74X2 G1/4X19
 喷口连接螺纹 (OUTLET THERAD): M16X1.5
 虹吸管连接螺纹 (DIP TUBE THERAD): M16X1.5
 超压释放压力 (PRESSURE MPA): 2.3-2.8

WN54-01

- 瓶口连接螺纹 (INLET THERAD): M30X1.5
 喷口连接螺纹 (OUTLET THERAD): 1/8"BSP
 装表连接螺纹 (GAUGE CONNECTION THERAD): M10X1X12.5
 虹吸管连接螺纹 (DIP TUBE THERAD): M16X1
 用气门芯或密封芯 (CHECK VALVE): 密封芯

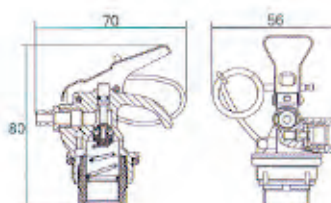

WN54-02

- 瓶口连接螺纹 (INLET THERAD): M30X1.5
 喷口连接螺纹 (OUTLET THERAD): M10X1
 装表连接螺纹 (GAUGE CONNECTION THERAD): M10X1
 虹吸管连接螺纹 (PRESSURE MPA): M16X1.5

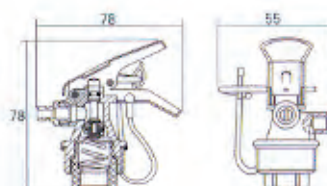

WN54-03

- 瓶口连接螺纹 (INLET THERAD): M30X1.5
 喷口连接螺纹 (OUTLET THERAD): $\Phi 4$
 装表连接螺纹 (GAUGE CONNECTION THERAD): M10X1X12.5
 虹吸管连接螺纹 (DIP TUBE THERAD): M16X1
 用气门芯或密封芯 (PRESSURE MPA): 密封芯

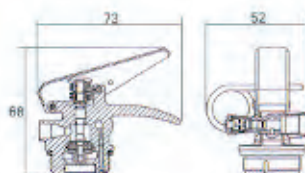

WN54-04

- 瓶口连接螺纹 (INLET THERAD): M24X1.5
 喷口连接螺纹 (OUTLET THERAD): M12X1.5
 装表连接螺纹 (GAUGE CONNECTION THERAD): M10X1X12.5
 虹吸管连接螺纹 (DIP TUBE THERAD): M14X1.5
 超压释放压力 (PRESSURE MPA): 2.3-2.8

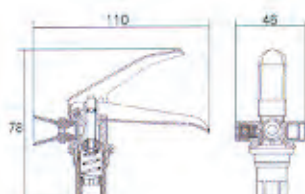

WN54-05

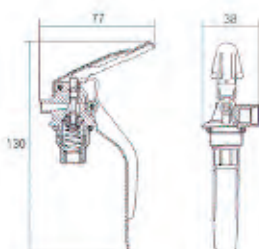

- 瓶口连接螺纹 (INLET THERAD): 7/8-20UNEF
 喷口连接螺纹 (OUTLET THERAD): $\phi 3$
 装表连接螺纹 (GAUGE CONNECTION THERAD): M10X1X12.5
 虹吸管连接螺纹 (DIP TUBE THERAD): M10X1

WN54-06

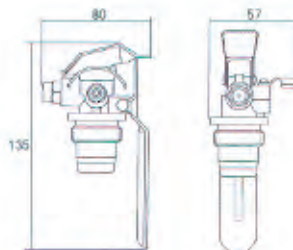

- 瓶口连接螺纹 (INLET THERAD): M30X2
 喷口连接螺纹 (OUTLET THERAD): M11X1
 装表连接螺纹 (GAUGE CONNECTION THERAD): 1/8" BSP
 虹吸管连接螺纹 (DIP TUBE THERAD): 7/8X14UNF

WN54-07

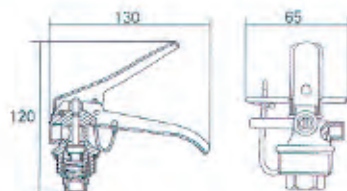

- 瓶口连接螺纹 (INLET THERAD): M30X1.5
 喷口连接螺纹 (OUTLET THERAD): M14X1.5
 装表连接螺纹 (GAUGE CONNECTION THERAD): 1/8"NPT
 虹吸管连接螺纹 (DIP TUBE THERAD): M14X1.25

WN54-08

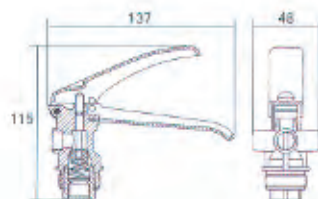

- 瓶口连接螺纹 (INLET THERAD): M30X1.5
 喷口连接螺纹 (OUTLET THERAD): M14X1.5
 装表连接螺纹 (GAUGE CONNECTION THERAD): M16X1.5
 虹吸管连接螺纹 (DIP TUBE THERAD): M16X1

WN54-09

阀门 VALVE

- 瓶口连接螺纹 (INLET THERAD): M22X1.5
 喷口连接螺纹 (OUTLET THERAD): $\Phi 3$
 装表连接螺纹 (GAUGE CONNECTION THERAD): NPT1/8X27
 用气门芯或密封芯 (CHECK VALVE): 气门芯

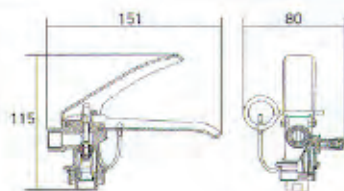

WN54-10

- 瓶口连接螺纹 (INLET THERAD): M22X1.5
 喷口连接螺纹 (OUTLET THERAD): $\Phi 3$
 虹吸管连接螺纹 (DIP TUBE THERAD): M10X1
 超压释放压力 (PRESSURE MPA): 2.3-2.8

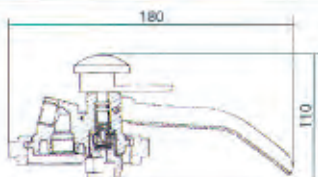

WN55-01 WN55-02

雨淋阀 DELUGE VALVE

- WN55-01
 连接螺纹 (INLET THERAD): ZG1/2X14
 公称动作温度 (TEMPERATURE): 68°C

- WN55-02
 连接螺纹 (INLET THERAD): ZG1/2X14
 公称动作温度 (TEMPERATURE): 79°C

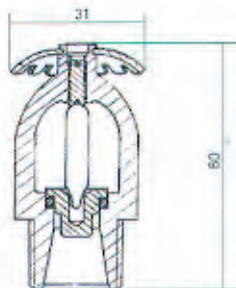

WN55-03 WN55-04

- WN55-03
 连接螺纹 (INLET THERAD): ZG1/2X14
 公称动作温度 (TEMPERATURE): 79°C

- WN55-04
 连接螺纹 (INLET THERAD): ZG1/2X14
 公称动作温度 (TEMPERATURE): 79°C

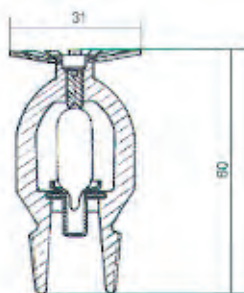

WN55-05 WN55-06

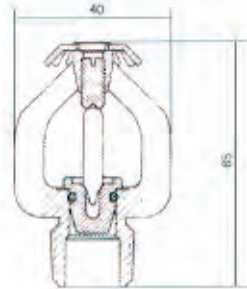
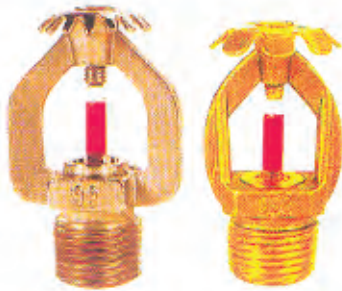

WN55-05
 连接螺纹 (INLET THERAD): ZG1/2X14
 公称动作温度 (TEMPERATURE): 68°C

WN55-06
 连接螺纹 (INLET THERAD): ZG1/2X14
 公称动作温度 (TEMPERATURE): 68°C

WN55-07 WN55-08

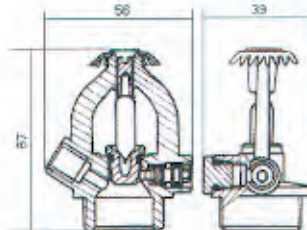
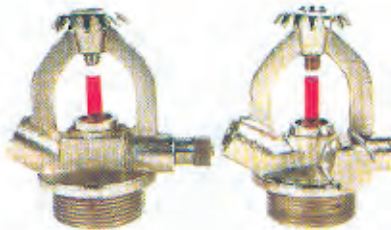

WN55-07
 瓶口连接螺纹 (INLET THERAD): M30X1.5
 装表连接螺纹 (GAUGE CONNECTION THERAD): NPT1/8X27
 公称动作温度 (TEMPERATURE): 68°C
 用气门芯或密封芯 (CHECK VALVE): 气门芯

WN55-08
 瓶口连接螺纹 (INLET THERAD): M30X1.5
 装表连接螺纹 (GAUGE CONNECTION THERAD): NPT1/8X27
 公称动作温度 (TEMPERATURE): 68°C
 用气门芯或密封芯 (CHECK VALVE): 锥度关闭

WN55-09

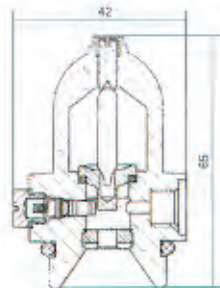

瓶口连接螺纹 (INLET THERAD): M30X1.5
 装表连接螺纹 (GAUGE CONNECTION THERAD): G1/8X27
 公称动作温度 (TEMPERATURE): 68°C
 用气门芯或密封芯 (CHECK VALVE): 气门芯

WN55-10

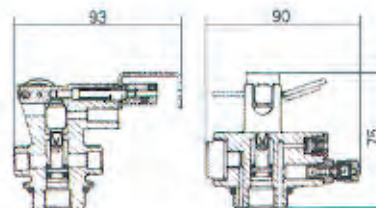

瓶口连接螺纹 (INLET THERAD): M30X1.5
 出口连接螺纹 (OUTLET THERAD): G3/8X19
 装表连接螺纹 (GAUGE CONNECTION THERAD): NPT1/8X27
 虹吸管连接螺纹 (DIP TUBE THERAD): M16X1.5
 超压释放压力 (PRESSURE MPA): 2.3-2.8
 公称动作温度 (TEMPERATURE): 68°C
 用气门芯或密封芯 (CHECK VALVE): 密封芯

WN55-11

连接螺纹 (INLET THERAD): 1/2BSPT
公称动作温度 (TEMPERATURE): 57,68,79,93,141°C

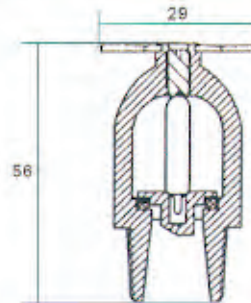

WN55-12

连接螺纹 (INLET THERAD): 1/2BSPT
公称动作温度 (TEMPERATURE): 57,68,79,93,141°C

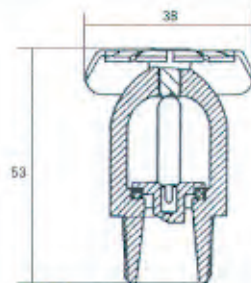

WN55-13

连接螺纹 (INLET THERAD): 1/2BSPT
公称动作温度 (TEMPERATURE): 57,68,79,93,141°C

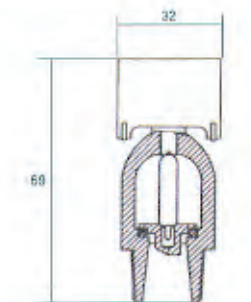

WN55-14

连接螺纹 (INLET THERAD): 1/2BSPT
公称动作温度 (TEMPERATURE): 57,68,79,93,141°C

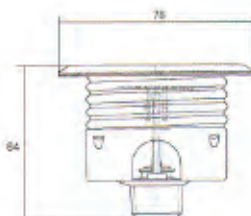

WN56-01

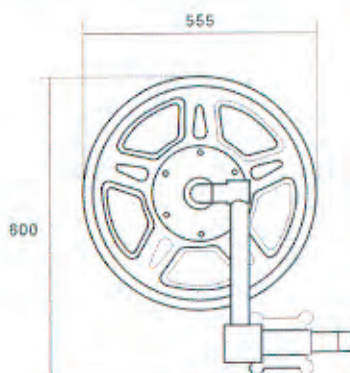
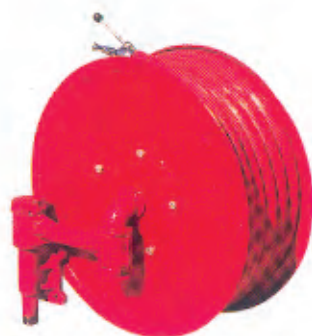

3/4"TAIL 30mm;25mm;20mm
1"TAIL 30mm;25mm;20mm

WN56-02

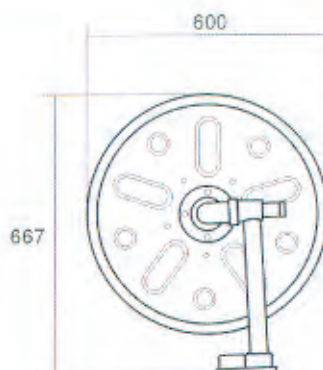

3/4"TAIL 30mm;25mm;20mm
1"TAIL 30mm;25mm;20mm

WN56-03

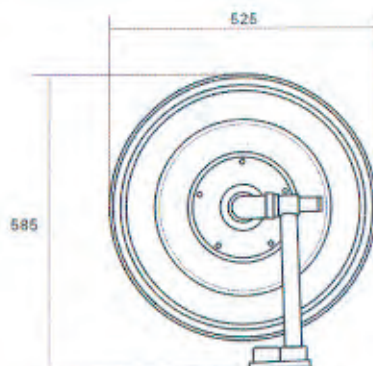

3/4"TAIL 30mm;25mm;20mm
1"TAIL 30mm;25mm;20mm

Type	Specification	Weight(g/m)	Working Pressure	Bursting Pressure	Length
C8	40	240	0.8Mpa 8bar 340PSI	≥2.4Mpa 24bar 340PSI	10-30
	45	270			
	50	320			
	65	420			
	70	500			
C10	40	250	1.0Mpa 10bar 140PSI	≥3.0Mpa 30bar 425PSI	
	45	290			
	50	330			
	65	420			
	70	520			
C10	80	550	1.3Mpa 13bar 185PSI	≥3.9Mpa 39bar 555PSI	
	40	280			
	45	310			
	50	380			
	65	480			
	70	550			
	100	900			
150	1000				

RUBBER LINING FIRE HOSE

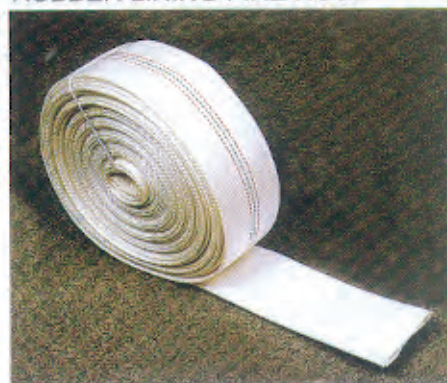

This product is made by adoption of high-strength synthetic fiber woven outer jacket, lined with rubber, featuring good pressure resistance, anti-wear, anti-erosion, impermeability, little water flow resistance, quick water output, lightness and softness, long service life, etc. can be used with fire plugs, pumps or vehicles, for conveyance of water or other extinguishing agents, and can also be extensively used in fields of industry, mining, navigation and transportation, petrochemistry, agriculture, etc.

Type	Specification	Weight(g/m)	Working Pressure	Bursting Pressure	Length
13	25	110	1.3Mpa 13bar 185PSI	≥3.9Mpa 39bar 555PSI	100
	40	130			
	45	165			
	50	190			
	65	250			
	70	265			
	80	320			
	90	420			
16	100	490	1.6Mpa 13bar 185PSI	≥3.9Mpa 39bar 555PSI	
	25	120			
	40	160			
	45	180			
	50	210			
	65	270			
	70	290			
20	80	350	2.0Mpa 20bar 270PSI	≥6.0Mpa 60bar 850PSI	
	90	600			
	45	205			
	65	300			
	70	330			
25	80	380	2.5Mpa 25bar 350PSI	≥7.5Mpa 75bar 850PSI	
	90	600			
	45	230			
	65	320			
40	70	385	4.0Mpa 40bar 570PSI	≥8.0Mpa 80bar 1130PSI	
	80	420			
	25	200			
	40	280			

PU LINING FIRE HOSE



Being lined with polyurethane, the hose, made with the advanced equipments and materials which were imported from Europe, gets thinner, softer and lighter. It is more convenient in use, resistant to high pressure. The weight of unit length is 40% lighter than the rubber lining hose, and single length can reach 100m. This new product can help the firefighter to improve their firefighting abilities.